



User Manual

SOM-6898

COM Express Compact Module

ADVANTECH

Enabling an Intelligent Planet

Copyright

The documentation and the software included with this product are copyrighted 2017 by Advantech Co., Ltd. All rights are reserved. Advantech Co., Ltd. reserves the right to make improvements in the products described in this manual at any time without notice. No part of this manual may be reproduced, copied, translated or transmitted in any form or by any means without the prior written permission of Advantech Co., Ltd. Information provided in this manual is intended to be accurate and reliable. However, Advantech Co., Ltd. assumes no responsibility for its use, nor for any infringements of the rights of third parties, which may result from its use.

Acknowledgements

Intel is a trademark of Intel Corporation.

Microsoft Windows and MS-DOS are registered trademarks of Microsoft Corp.

All other product names or trademarks are properties of their respective owners.

Product Warranty (2 years)

Advantech warrants to you, the original purchaser, that each of its products will be free from defects in materials and workmanship for two years from the date of purchase.

This warranty does not apply to any products which have been repaired or altered by persons other than repair personnel authorized by Advantech, or which have been subject to misuse, abuse, accident or improper installation. Advantech assumes no liability under the terms of this warranty as a consequence of such events.

Because of Advantech's high quality-control standards and rigorous testing, most of our customers never need to use our repair service. If an Advantech product is defective, it will be repaired or replaced at no charge during the warranty period. For out-of-warranty repairs, you will be billed according to the cost of replacement materials, service time and freight. Please consult your dealer for more details.

If you think you have a defective product, follow these steps:

1. Collect all the information about the problem encountered. (For example, CPU speed, Advantech products used, other hardware and software used, etc.) Note anything abnormal and list any onscreen messages you get when the problem occurs.
2. Call your dealer and describe the problem. Please have your manual, product, and any helpful information readily available.
3. If your product is diagnosed as defective, obtain an RMA (return merchandise authorization) number from your dealer. This allows us to process your return more quickly.
4. Carefully pack the defective product, a fully-completed Repair and Replacement Order Card and a photocopy proof of purchase date (such as your sales receipt) in a shippable container. A product returned without proof of the purchase date is not eligible for warranty service.
5. Write the RMA number visibly on the outside of the package and ship it prepaid to your dealer.

Part No. 2006689800

Printed in Taiwan

Edition 1

July 2017

Declaration of Conformity

CE

This product has passed the CE test for environmental specifications. Test conditions for passing included the equipment being operated within an industrial enclosure. In order to protect the product from being damaged by ESD (Electrostatic Discharge) and EMI leakage, we strongly recommend the use of CE-compliant industrial enclosure products.

FCC Class B

Note: This equipment has been tested and found to comply with the limits for a Class B digital device, pursuant to part 15 of the FCC Rules. These limits are designed to provide reasonable protection against harmful interference in a residential installation. This equipment generates, uses and can radiate radio frequency energy and, if not installed and used in accordance with the instructions, may cause harmful interference to radio communications. However, there is no guarantee that interference will not occur in a particular installation. If this equipment does cause harmful interference to radio or television reception, which can be determined by turning the equipment off and on, the user is encouraged to try to correct the interference by one or more of the following measures:

- Reorient or relocate the receiving antenna.
- Increase the separation between the equipment and receiver.
- Connect the equipment into an outlet on a circuit different from that to which the receiver is connected.
- Consult the dealer or an experienced radio/TV technician for help.

FM

This equipment has passed the FM certification. According to the National Fire Protection Association, work sites are classified into different classes, divisions and groups, based on hazard considerations. This equipment is compliant with the specifications of Class I, Division 2, Groups A, B, C and D indoor hazards.

Technical Support and Assistance

1. Visit the Advantech website at <http://support.advantech.com> where you can find the latest information about the product.
2. Contact your distributor, sales representative, or Advantech's customer service center for technical support if you need additional assistance. Please have the following information ready before you call:
 - Product name and serial number
 - Description of your peripheral attachments
 - Description of your software (operating system, version, application software, etc.)
 - A complete description of the problem
 - The exact wording of any error messages

Warnings, Cautions and Notes

Warning! Warnings indicate conditions, which if not observed, can cause personal injury!



Caution! Cautions are included to help you avoid damaging hardware or losing data. e.g.



There is a danger of a new battery exploding if it is incorrectly installed. Do not attempt to recharge, force open, or heat the battery. Replace the battery only with the same or equivalent type recommended by the manufacturer. Discard used batteries according to the manufacturer's instructions.

Note! Notes provide optional additional information.



Document Feedback

To assist us in making improvements to this manual, we would welcome comments and constructive criticism. Please send all such - in writing to: support@advantech.com

Packing List

Before setting up the system, check that the items listed below are included and in good condition. If any item does not accord with the table, please contact your dealer immediately.

- SOM-6898 CPU module
- 1 x Heatsreader (1960080159N000)

Safety Instructions

1. Read these safety instructions carefully.
2. Keep this User Manual for later reference.
3. Disconnect this equipment from any AC outlet before cleaning. Use a damp cloth. Do not use liquid or spray detergents for cleaning.
4. For plug-in equipment, the power outlet socket must be located near the equipment and must be easily accessible.
5. Keep this equipment away from humidity.
6. Put this equipment on a reliable surface during installation. Dropping it or letting it fall may cause damage.
7. The openings on the enclosure are for air convection. Protect the equipment from overheating. **DO NOT COVER THE OPENINGS.**
8. Make sure the voltage of the power source is correct before connecting the equipment to the power outlet.
9. Position the power cord so that people cannot step on it. Do not place anything over the power cord.
10. All cautions and warnings on the equipment should be noted.
11. If the equipment is not used for a long time, disconnect it from the power source to avoid damage by transient overvoltage.
12. Never pour any liquid into an opening. This may cause fire or electrical shock.
13. Never open the equipment. For safety reasons, the equipment should be opened only by qualified service personnel.
14. If one of the following situations arises, get the equipment checked by service personnel:
 - The power cord or plug is damaged.
 - Liquid has penetrated into the equipment.
 - The equipment has been exposed to moisture.
 - The equipment does not work well, or you cannot get it to work according to the user's manual.
 - The equipment has been dropped and damaged.
 - The equipment has obvious signs of breakage.
15. **DO NOT LEAVE THIS EQUIPMENT IN AN ENVIRONMENT WHERE THE STORAGE TEMPERATURE MAY GO BELOW -20° C (-4° F) OR ABOVE 60° C (140° F). THIS COULD DAMAGE THE EQUIPMENT. THE EQUIPMENT SHOULD BE IN A CONTROLLED ENVIRONMENT.**
16. **CAUTION: DANGER OF EXPLOSION IF BATTERY IS INCORRECTLY REPLACED. REPLACE ONLY WITH THE SAME OR EQUIVALENT TYPE RECOMMENDED BY THE MANUFACTURER, DISCARD USED BATTERIES ACCORDING TO THE MANUFACTURER'S INSTRUCTIONS.**

The sound pressure level at the operator's position according to IEC 704-1:1982 is no more than 70 dB (A).

DISCLAIMER: This set of instructions is given according to IEC 704-1. Advantech disclaims all responsibility for the accuracy of any statements contained herein.

Safety Precaution - Static Electricity

Follow these simple precautions to protect yourself from harm and the products from damage.

- To avoid electrical shock, always disconnect the power from your PC chassis before you work on it. Don't touch any components on the CPU card or other cards while the PC is on.
- Disconnect power before making any configuration changes. The sudden rush of power as you connect a jumper or install a card may damage sensitive electronic components.

Contents

| | | |
|------------------|--|-----------|
| Chapter 1 | General Information | 1 |
| 1.1 | Introduction | 2 |
| 1.2 | Specifications | 2 |
| 1.2.1 | Board Information | 2 |
| 1.2.2 | System Information | 2 |
| 1.2.3 | Display | 3 |
| 1.2.4 | Expansion Interface | 3 |
| 1.2.5 | I/O | 4 |
| 1.2.6 | iManager 2.0 | 4 |
| 1.2.7 | Mechanical and Environmental Specification | 4 |
| 1.3 | Functional Block Diagram | 5 |
| Chapter 2 | Mechanical Information | 7 |
| 2.1 | Board Information..... | 8 |
| | Figure 2.1 Board Chips Identify - Front..... | 8 |
| | Figure 2.2 Board Chips Identify - Back | 8 |
| 2.2 | Mechanical Drawing..... | 9 |
| | Figure 2.3 Board Mechanical Drawing - Front | 9 |
| | Figure 2.4 Board Mechanical Drawing - Back | 9 |
| 2.3 | Assembly Drawing | 10 |
| | Figure 2.5 Assembly Drawing..... | 10 |
| 2.4 | Assembly Drawing | 10 |
| | Figure 2.6 Main Chip Height and Tolerance (GT2)..... | 11 |
| | Figure 2.7 Main Chip Height and Tolerance (GT3)..... | 11 |
| Chapter 3 | BIOS Operation | 13 |
| | Figure 3.1 Setup program initial screen | 14 |
| 3.1 | Entering Setup | 15 |
| 3.1.1 | Main Setup..... | 15 |
| | Figure 3.2 Main setup screen | 15 |
| 3.1.2 | Advanced BIOS Features Setup..... | 16 |
| | Figure 3.3 Advanced BIOS features setup screen | 16 |
| | Figure 3.4 Power & Performance | 18 |
| | Figure 3.5 CPU- Power Management Control | 19 |
| | Figure 3.6 GT- Power Management Control..... | 20 |
| | Figure 3.7 Firmware Update Configuration..... | 22 |
| | Figure 3.8 PTT Configuration | 23 |
| | Figure 3.9 Trusted Computing | 24 |
| | Figure 3.10ACPI Settings | 25 |
| | Figure 3.11iManager Configuration | 26 |
| | Figure 3.12Serial Port 1 Configurations..... | 27 |
| | Figure 3.13Serial Port 2 Configurations..... | 28 |
| | Figure 3.14Hardware Monitor | 29 |
| | Figure 3.15W83627DHGSEC Super IO Configuration | 30 |
| | Figure 3.16Serial Port 3 Configurations..... | 31 |
| | Figure 3.17Serial Port 4 Configurations..... | 32 |
| | Figure 3.18Parallel Port Configuration..... | 33 |
| | Figure 3.19Serial Port Console Redirection | 34 |
| | Figure 3.20Legacy Console Redirection Settings..... | 35 |
| | Figure 3.21Network Stack Configuration | 36 |
| | Figure 3.22CSM Configuration | 37 |

| | | |
|-------------------|---|-----------|
| | Figure 3.23 NVMe Configuration | 38 |
| | Figure 3.24 USB Configuration | 39 |
| 3.1.3 | Chipset | 40 |
| | Figure 3.25 Chipset Setup | 40 |
| | Figure 3.26 System Agent (SA) Configuration | 41 |
| | Figure 3.27 Memory Configuration | 42 |
| | Figure 3.28 Graphics Configuration | 43 |
| | Figure 3.29 PCH-IO Configuration | 44 |
| | Figure 3.30 PCI Express Configuration | 45 |
| | Figure 3.31 PCI Express Root Port 0 Configuration | 46 |
| | Figure 3.32 PCI Express Root Port 1 Configuration | 47 |
| | Figure 3.33 PCI Express Root Port 2 Configuration | 48 |
| | Figure 3.34 PCI Express Root Port 3 Configuration | 49 |
| | Figure 3.35 PCI Express Root Port 4 Configuration | 50 |
| | Figure 3.36 SATA And RST Configuration | 51 |
| | Figure 3.37 USB Configuration | 52 |
| | Figure 3.38 HD Audio Configuration | 53 |
| | Figure 3.39 SCS Configuration | 54 |
| | Figure 3.40 SB Porting Configuration | 55 |
| 3.1.4 | Security Setting | 56 |
| | Figure 3.41 Security Setup | 56 |
| 3.1.5 | Boot Settings | 57 |
| | Figure 3.42 Boot Settings | 57 |
| 3.1.6 | Save & Exit | 58 |
| | Figure 3.43 Save & Exit | 58 |
| Chapter 4 | S/W Introduction & Installation..... | 61 |
| 4.1 | S/W Introduction | 62 |
| 4.2 | Driver Installation | 62 |
| | 4.2.1 Windows Driver Setup | 62 |
| | 4.2.2 Other OS | 62 |
| 4.3 | Advantech iManager | 63 |
| Appendix A | Pin Assignment..... | 65 |
| A.1 | SOM-6898 Type 6 Pin Assignment..... | 66 |
| Appendix B | Watchdog Timer..... | 71 |
| B.1 | Programming the Watchdog Timer | 72 |
| Appendix C | Programming GPIO..... | 73 |
| C.1 | GPIO Register..... | 74 |
| Appendix D | System Assignments..... | 75 |
| D.1 | System I/O Ports..... | 76 |
| | Table D.1: System I/O ports..... | 76 |
| D.2 | Interrupt Assignments | 77 |
| | Table D.2: Interrupt Assignments | 77 |
| D.3 | 1st MB Memory Map | 78 |
| | Table D.3: 1st MB Memory Map | 78 |

Chapter 1

General Information

This chapter gives background information on the SOM-6898 CPU Computer on Module.

Sections include:

- Introduction
- Specification
- Functional Block Diagram

1.1 Introduction

SOM-6898 is a COM Express Compact module with type 6 pin-out that fully complies with the PICMG (PCI Industrial Computer Manufacturers Group) COM.0 R2.1 specification. The CPU module uses an Intel 7th Generation Core i processor and other peripheral chips in a basic size 95x95mm COM Express form factor. SOM-6898 features a 15 watt TDP and is equipped with a power-saving ULV-SoC on new 14nm micro architecture. SOM-6898 supports up to 32GB dual channel DDR4 2133 non-ECC, with higher memory bandwidth for better performance. SOM-6898 is equipped with an integrated Intel Gen 9 LP graphics micro architecture, supplying up to three independently operated 4K displays via DisplayPort. It also supports HW accelerated video decoding for AVC, VC1, MPEG2, HEVC, VP8, JPEG. SOM-6898 I/O includes PCI Express Gen 3, 2 SATA G3, 4 USB 3.0, 8 USB 2.0. Moreover, 5 PCIe x1 (4 PCIe x1 + 1 PCIe x4 (support up to 5 devices and 8 lanes) can be supported at a time to make the IO design more flexible. In addition, SOM-6898 adds mounting holes around the processor to strengthen the board structure and avoid board bending.

Advantech iManager was designed to satisfy a lot of embedded application requirements such as multi-level watchdog timer, voltage and temperature monitoring, and thermal protection through processor throttling, as well as LCD backlight on/off, brightness control, and embedded storage information. Combined with Advantech SUSI Access, it can remotely monitor and control devices via the internet for easy maintenance. All Advantech COM Express modules integrate iManager and SUSI Access to benefit customer's applications. SOM-6898 is suitable for computing intensive, thermal sensitive, graphics/media intense, and I/O demanding applications.

1.2 Specifications

1.2.1 Board Information

- **Pin Definition:** PICMG COM.0 R2.1 Type 6 pin-out definition
- **Form Factor:** PICMG COM.0 R2.1 Compact Module 95 x 95 mm

1.2.2 System Information

- **CPU:** 7th Gen Intel® Core Processors

| CPU | Standard Freq. | Max. Turbo Freq. | Core | Cache (MB) | TDP(W) |
|---------------|----------------|------------------|------|------------|--------|
| i7-7600U | 2.8GHz | 3.9GHz | 2 | 4 | 15 |
| I5-7300U | 2.6GHz | 3.5GHz | 2 | 4 | 15 |
| i3-7100U | 2.4GHz | NA | 2 | 4 | 15 |
| Celeron 3965U | 2.2GHz | NA | 2 | 2 | 15 |

- **Memory:** 2 SODIMM Socket for DDR4 2133, up to 32 GB
- **BIOS:** AMI UEFI
- **Power management:** Supports power saving modes including Normal / Standby / Suspend modes. ACPI 2.0 compliant.

1.2.3 Display

- **Graphic Core:** Intel® Gen 9 LP Graphic supports full HW accelerated video decoding for AVC/VC1/MPEG2/HEVC/VP8/JPEG.

| CPU | Graphics Core | Base Freq. | Max Freq. |
|---------------|------------------------|------------|-----------|
| i7-7600U | Intel® HD Graphics 620 | 300MHz | 1.15GHz |
| i5-7300U | Intel® HD Graphics 620 | 300MHz | 1.1GHz |
| i3-7100U | Intel® HD Graphics 620 | 300MHz | 1GHz |
| Celeron 3965U | Intel® HD Graphics 610 | 300MHz | 900MHz |

- **VGA:** Resolution up to 1920 x 1200
- **LVDS:** Single and dual channel 18/24-bit resolutions up to 1920 x 1200 @ 60 Hz
- **eDP:** optional, up to 3840 x 2160 @ 60Hz 24bpp or 4096 x 2304 @ 60Hz 24bpp
- **HDMI/DVI/DP:** Supports 3 ports HDMI (default), DVI, or DP multiplexed.
Resolution: HDMI up to 4096 x 2160 @24Hz
DVI up to 1920 x 1080 @ 60 Hz
DP up to 3840 x 2160 @ 60Hz 24bpp
or 4096 x 2304 @ 60Hz 24bpp
- **Dual Display:** VGA + LVDS, VGA + HDMI/DVI/DP, LVDS + HDMI/DVI/DP, VGA + eDP (Optional), eDP + HDMI/DVI/DP (Optional), HDMI/DVI/DP + HDMI/DVI/DP (Optional)
- **Triple Display:** VGA + LVDS + HDMI/DVI/DP, VGA + eDP + HDMI/DVI/DP (Optional), eDP + HDMI/DVI/DP + HDMI/DVI/DP (Optional)

1.2.4 Expansion Interface

- **PCI Express x1:** Supports default 5 ports PCIe x1 compliant.
To PCIe Gen3* (8.0 GT/s) specification, several configurable combinations may need BIOS modifies. Please contact Advantech sales or FAE for more detail.
(PCIe x1 Port #7 option with SATA2)

| | x4 | x2 | x1 |
|----------|----|----|----|
| Default | 1 | 0 | 4 |
| Option 1 | 0 | 0 | 5 |
| Option 2 | 2 | 0 | 0 |
| Option 3 | 1 | 2 | 0 |
| Option 4 | 1 | 1 | 2 |
| Option 5 | 0 | 4 | 0 |
| Option 6 | 0 | 2 | 3 |

- **Audio Interface:** Intel HD Audio interface
- **LPC Bus:** Yes (24MHz)
- **SMBus:** Yes
- **I2C Bus:** Up to 400KHz
- **SPI:** Supports SPI BIOS only

1.2.5 I/O

- **Ethernet:** Intel I219LM Gigabit LAN supports 10/100/1000 Mbps Speed
- **SATA:** Supports 2 ports SATA 3.0 (6 Gbit/s)
Support RAID 0/1/5/10, AHCI 1.3
*optional support 3 SATA 3.0 (6 Gbit/s)
- **USB Interface:** Supports 4 ports USB3.0, 8 ports USB 2.0
- **Serial Port:** Supports 2 ports 2-wire serial port
- **Express Card:** 2 ports
- **Panel Control:** Supports panel backlight on/off control, brightness control
- **Thermal Protection:** Supports thermal shutdown or CPU throttling
- **Watchdog Timer:** 65536 level timer interval, from 0~65535 sec, multi-level, multi-option watchdog timer
- **Smart Fan:** 1 port on Module, 1 port down to carrier board
- **GPIO:** 8-bit GPIO
- **Hardware Monitor:** Vin, 5VSB, CMOS
- **TPM:** Optional TPM2.0 (Infineon SLB9665)

1.2.6 iManager 2.0

Refer to section 4.3.

1.2.7 Mechanical and Environmental Specification

- **Dimensions:** 95 x 95 mm (3.74" x 3.74")
- **Power Type and Supply Voltage:**
 - ATX: +8.5~20V and +4.75~5.25VSB (standby power)
 - AT: +8.5~20V
 - CMOS Battery: +3.3V
- **Power Requirement:**
 - Test condition: SOM-6898C7-U8A1E (i7-7600U), ADVANTECH 16GB SO-
DDR4-2133 I-GRD 2PCS, Windows 10 Pro, rated voltage DC +5.0V, +12.0V,
+20.0V
 - Idle: 4.16W
 - Max: 24.61W (BurnIn Test V8.1 Pro (1016) for 64 bit Windows)
- **Temperature Specification:**
 - Operating: 0 ~ 60° C (32 ~ 140° F)
 - Storage: -40 ~ 85° C (-40 ~ 185° F)
- **Humidity Specification:**
 - Operating: 40° C @ 95% relative humidity, non-condensing
 - Storage: 60° C @ 95% relative humidity, non-condensing

1.3 Functional Block Diagram

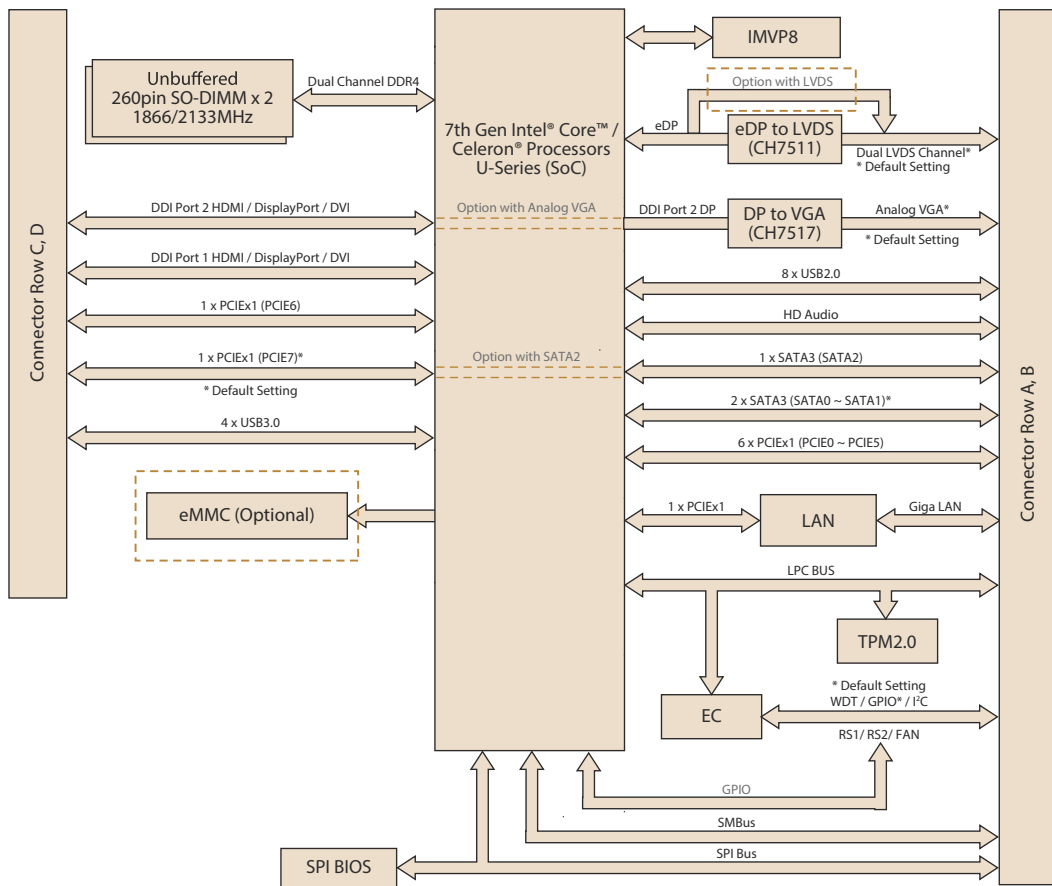

Chapter 2

Mechanical Information

This chapter gives mechanical information on the SOM-6898 CPU Computer on Module.

Sections include:

- Board Information
- Mechanical Drawing
- Assembly Drawing

2.1 Board Information

The figures below indicate the main chips on SOM-6898 Computer-on-Module. Be aware of these positions when designing your own carrier board to avoid mechanical issues, as well as designing a thermal solution with contact points for the best thermal dissipation performance.

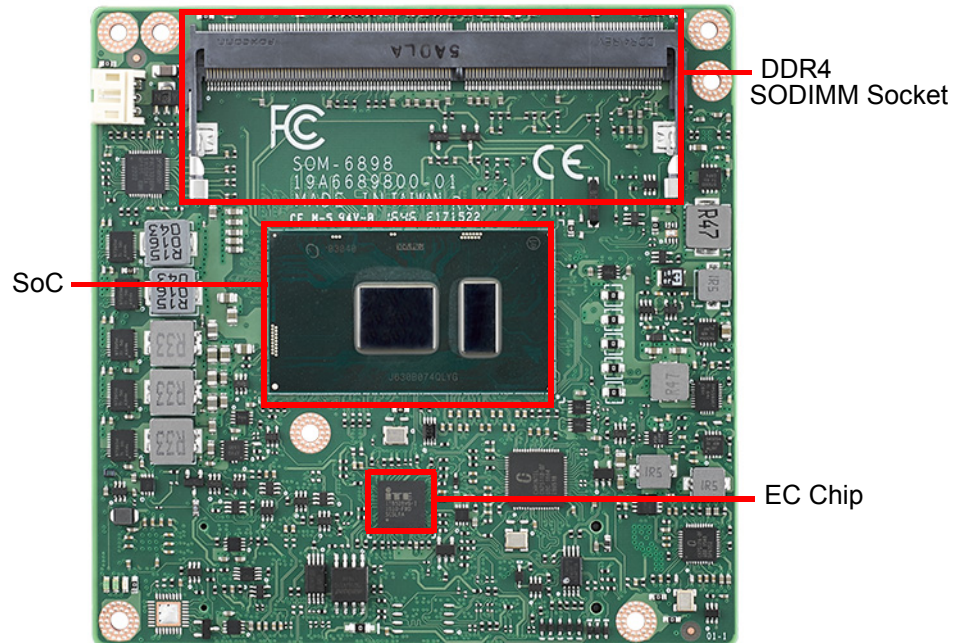

Figure 2.1 Board Chips Identify - Front

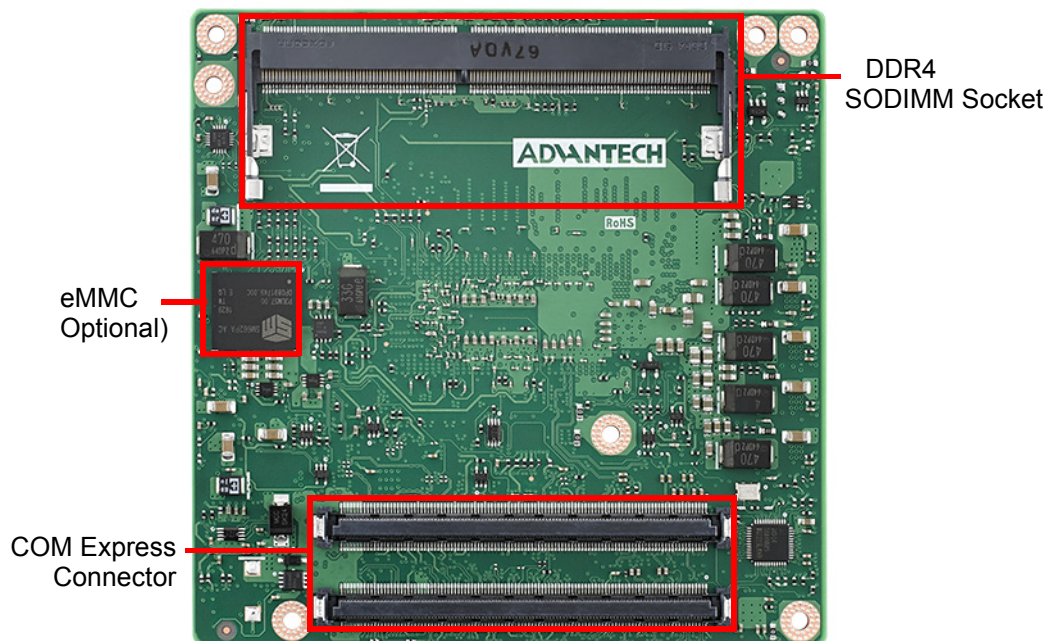

Figure 2.2 Board Chips Identify - Back

2.2 Mechanical Drawing

For more details about 2D/3D models, please look on the Advantech COM support service website <http://com.advantech.com>.

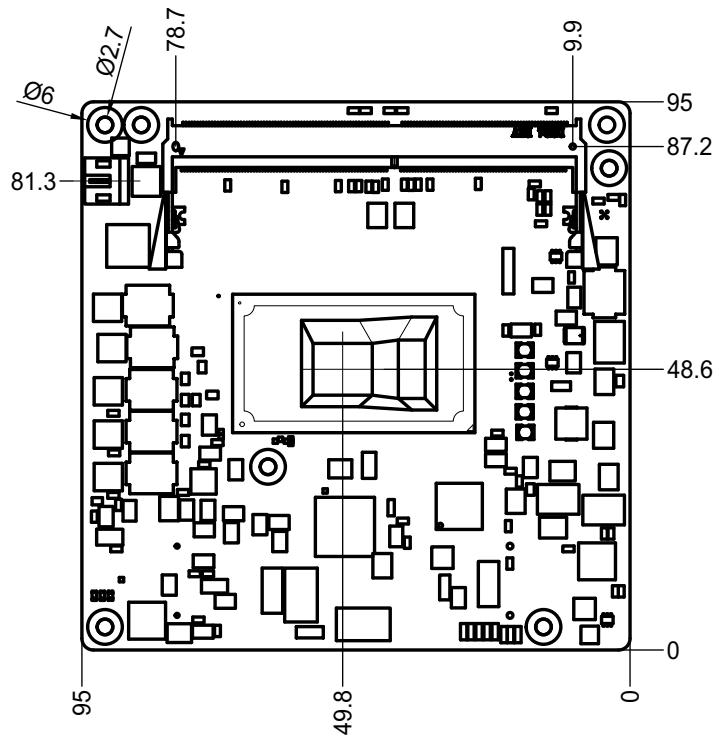

Figure 2.3 Board Mechanical Drawing - Front

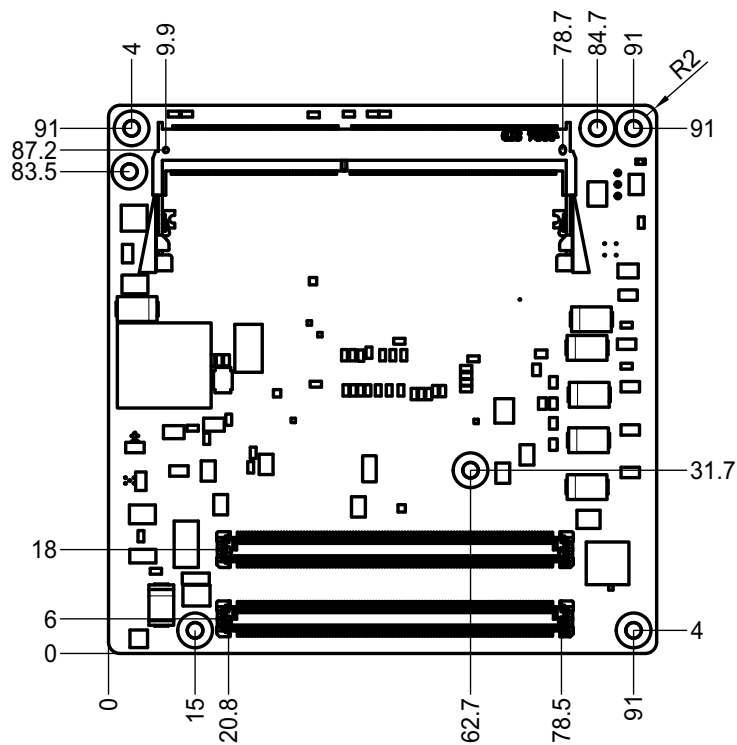

Figure 2.4 Board Mechanical Drawing - Back

2.3 Assembly Drawing

These figures demonstrate the assembly order from the thermal module, COM module to the carrier board.

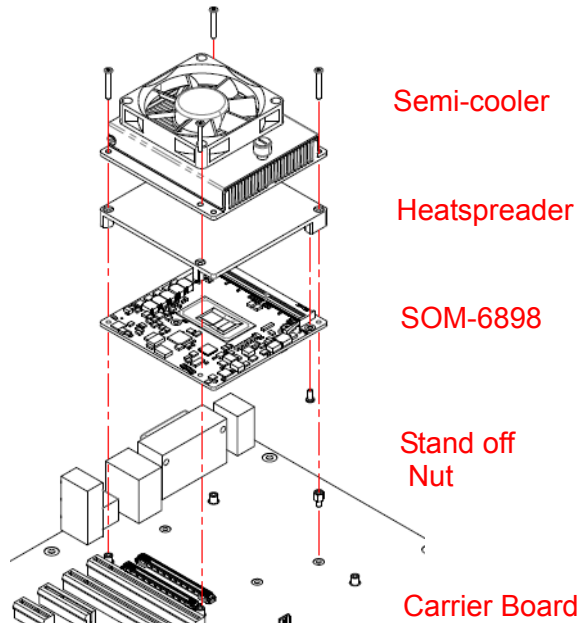
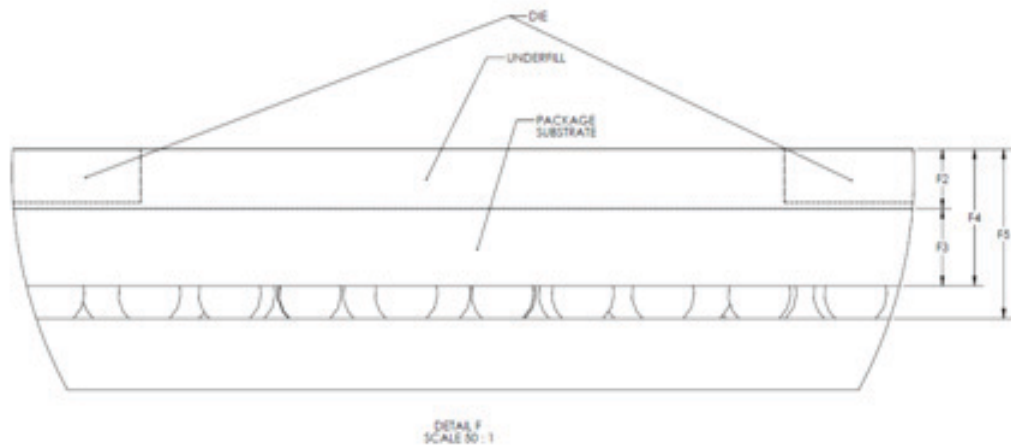

Figure 2.5 Assembly Drawing

2.4 Assembly Drawing

Please consider the CPU and chip height tolerance when designing your thermal solution.



F2=Option1 NOM: 0.315, TOL: ± 0.018

Option 2 NOM: 0.415, TOL: ± 0.018

F3=Option1 NOM: 0.537, TOL: ± 0.07

Option 2 NOM: 0.537, TOL: ± 0.07

F4=Option1 NOM: 0.852, TOL: ± 0.072

Option 2 NOM: 0.952, TOL: ± 0.072

F5=Option1 NOM: 1.08, TOL: ± 0.092

Option 2 NOM: 1.18, TOL: ± 0.092 (POST SMT STACKUP HEIGHT BASED ON LIMITED DATA FROM INTEL REFERENCE BOARD DESIGN)

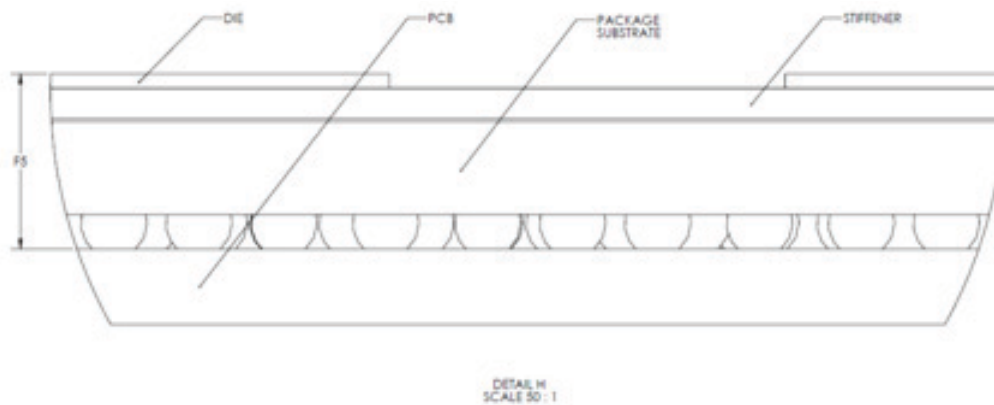
Figure 2.6 Main Chip Height and Tolerance (GT2)

F5= NOM: 1.213, TOL: ± 0.108 (PRE SMT PACKAGE HEIGHT)

NOM: 1.16, TOL: ± 0.108 (POST SMT STACKUP HEIGHT BASED ON LIMITED DATA FROM INTEL REFERENCE BOARD DESIGN)

Figure 2.7 Main Chip Height and Tolerance (GT3)

Chapter 3

BIOS Operation

This chapter gives BIOS setup information for the SOM-6898 CPU Computer on Module.

Sections include:

- Introduction
- Entering Setup
- Hot / Operation Key
- Exit BIOS Setup Utility

With the AMI BIOS Setup Utility, users can modify BIOS settings and control various system features. This chapter describes the basic navigation of the BIOS Setup Utility.



Figure 3.1 Setup program initial screen

AMI's BIOS ROM has a built-in Setup program that allows users to modify the basic system configuration. This information is stored in flash ROM so it retains setup information when the power is turned off.

3.1 Entering Setup

Turn on the computer and then press <ESC> or to enter Setup menu.

3.1.1 Main Setup

When users first enter the BIOS Setup Utility, they will enter the main setup screen. Users can always return to the Main setup screen by selecting the Main tab. There are two Main Setup options. They are described in this section. The Main BIOS setup screen is shown below.



Figure 3.2 Main setup screen

The Main BIOS setup screen has two main frames. The left frame displays all the options that can be configured. Grayed-out options cannot be configured; options in blue can. The right frame displays the key legend.

Above the key legend is an area reserved for a text message. When an option is selected in the left frame, it is highlighted in white. Often a text message will accompany it.

■ System time / System date

Use this option to change the system time and date. Highlight System Time or System Date using the <Arrow> keys. Enter new values through the keyboard. Press the <Tab> key or the <Arrow> keys to move between fields.

- System Date: mm/dd/yyyy
- System Time: hh/mm/ss

3.1.2 Advanced BIOS Features Setup

Select the Advanced tab from the SOM-6898 setup screen to enter the Advanced BIOS Setup screen. Users can select any item in the left frame of the screen, such as CPU Configuration, to go to the sub menu for that item. Users can display an Advanced BIOS Setup option by highlighting it using the <Arrow> keys. All Advanced BIOS Setup options are described in this section. The Advanced BIOS Setup screens are shown below. The sub menus are described on the following pages.

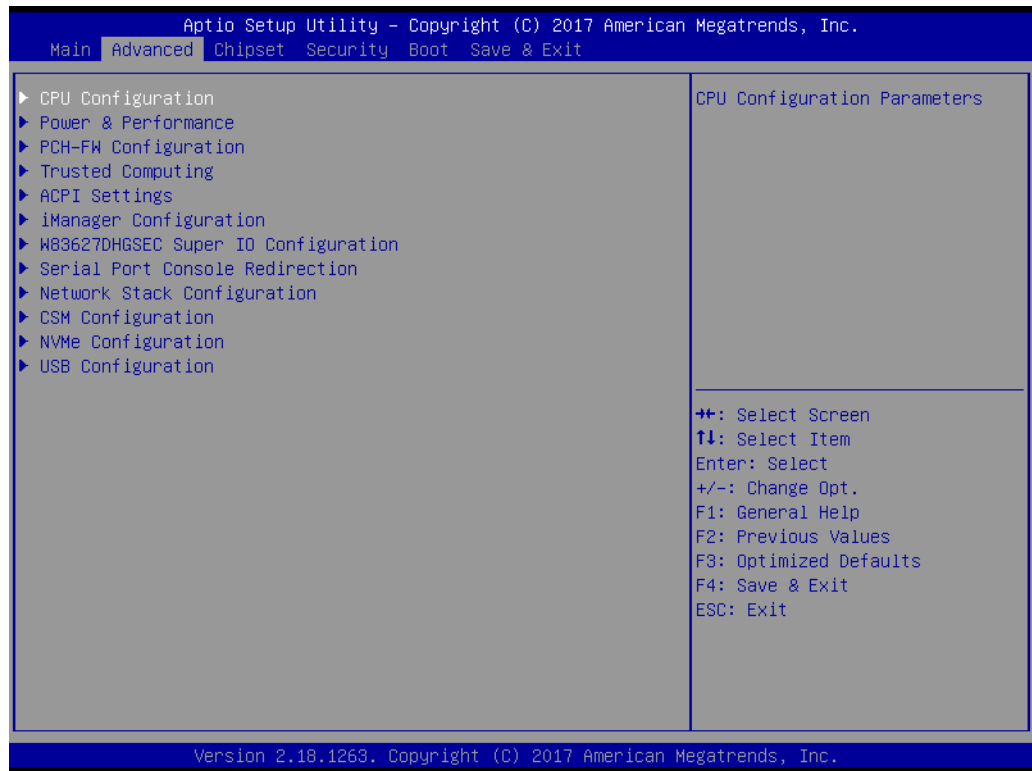

Figure 3.3 Advanced BIOS features setup screen

3.1.2.1 CPU Configuration



- **Intel (VMX) Virtualization Technology**
When enabled, a VMM can utilize the additional hardware capabilities provided by Vanderpool Technology.
- **Active Processor Core**
Number of cores to enable in each processor package.
- **Hyper-Threading**
Enabled for Windows XP and Linux (OS optimized for Hyper-Threading Technology) and Disabled for other OS (OS not optimized for Hyper-Threading Technology)
- **AES**
Enable/Disable AES (Advanced Encryption Standard)

3.1.2.2 Power & Performance

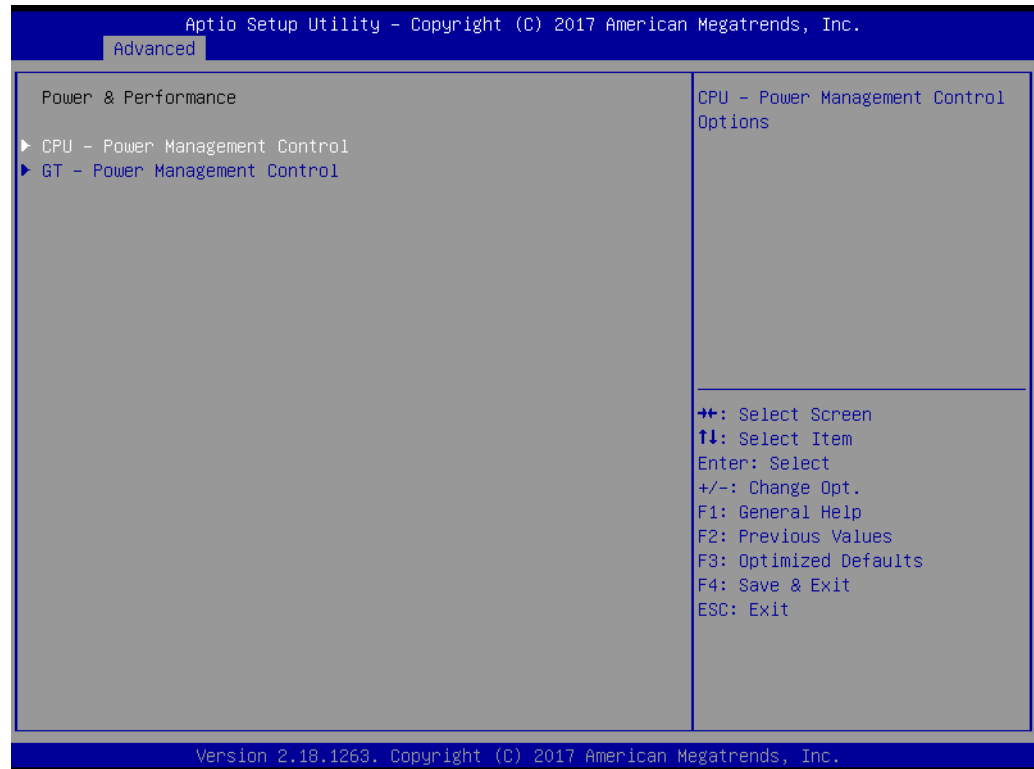

Figure 3.4 Power & Performance

- **CPU- Power Management Control**
CPU- Power Management Control Options
- **GT- Power Management Control**
GT- Power Management Control Options

■ CPU- Power Management Control

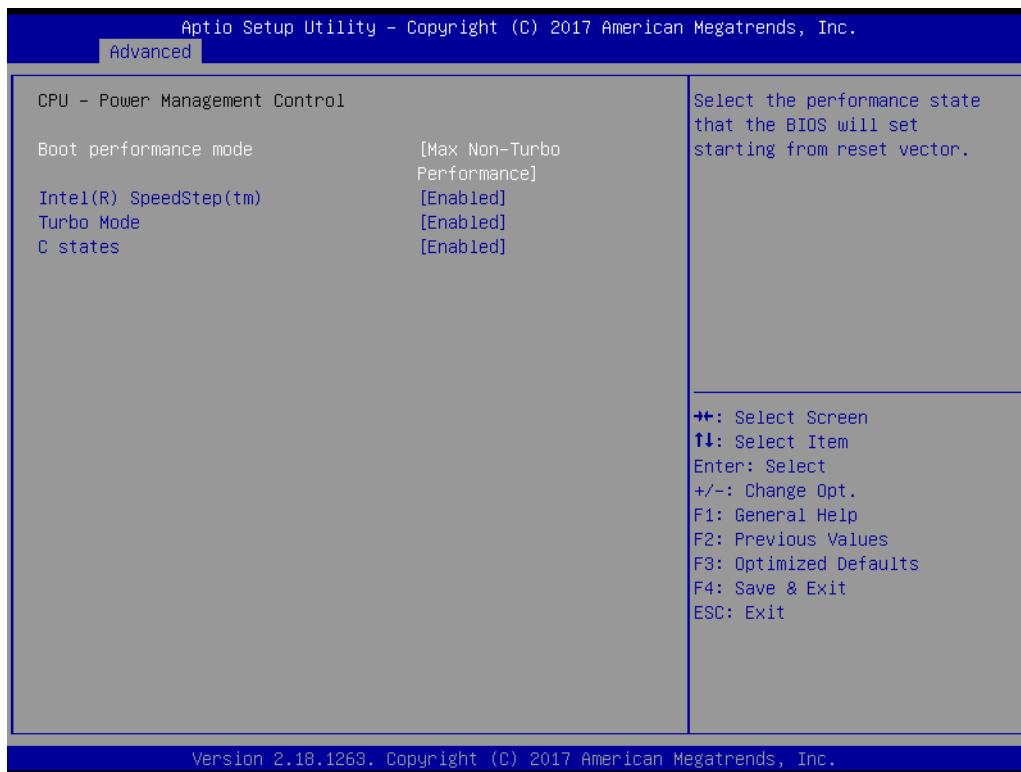

Figure 3.5 CPU- Power Management Control

- **Boot performance mode**
Select the performance state that the BIOS will set starting from reset vector
- **Intel® SpeedStep™**
Allows more than two frequency ranges to be supported.
- **Turbo Mode**
Enable/Disable processor Turbo Mode (requires EMTTM enabled too. AUTO means enabled, unless max turbo ratio is bigger than 16- SKL A0 W/A
- **C state**
Enable/Disable CPU Power Management. Allows CPU to go to C states when it's not 100% utilized.

■ GT- Power Management Control

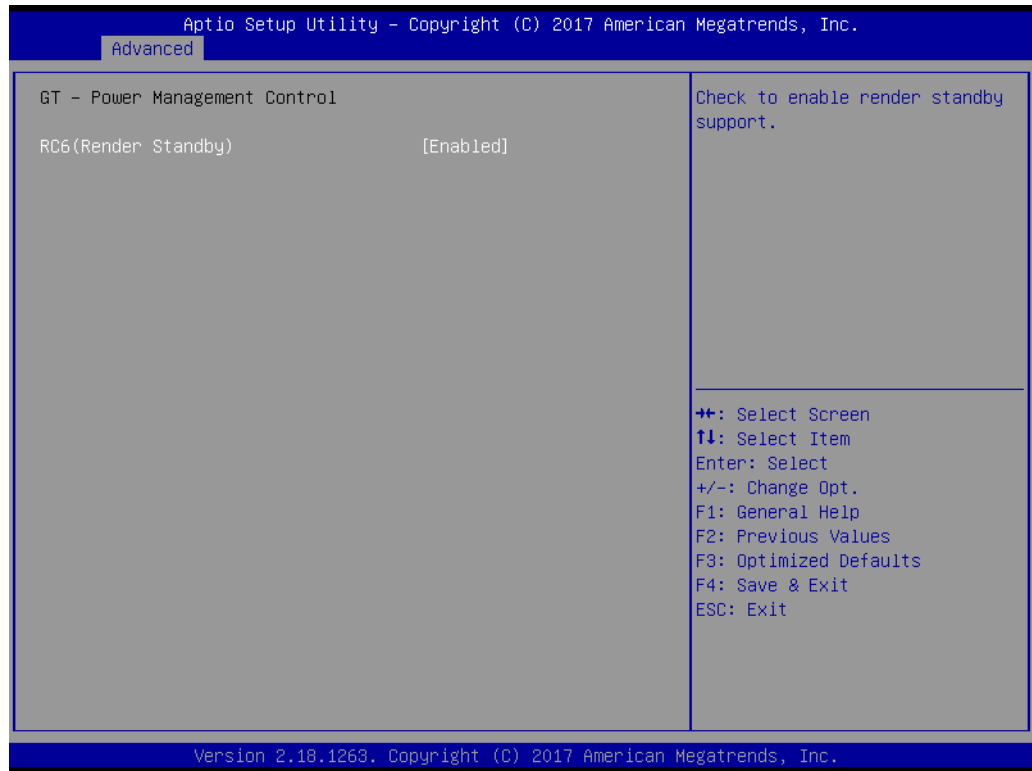

Figure 3.6 GT- Power Management Control

- **RC6 (Render Standby)**
Check to enable render standby support.

3.1.2.3 PCH-FW Configuration



- **ME State**
Sets ME to soft temporary disabled.
- **Firmware Update Configuration**
Configures management engine technology parameters.
- **PTT Configuration**
Configure PTT

■ Firmware Update Configuration

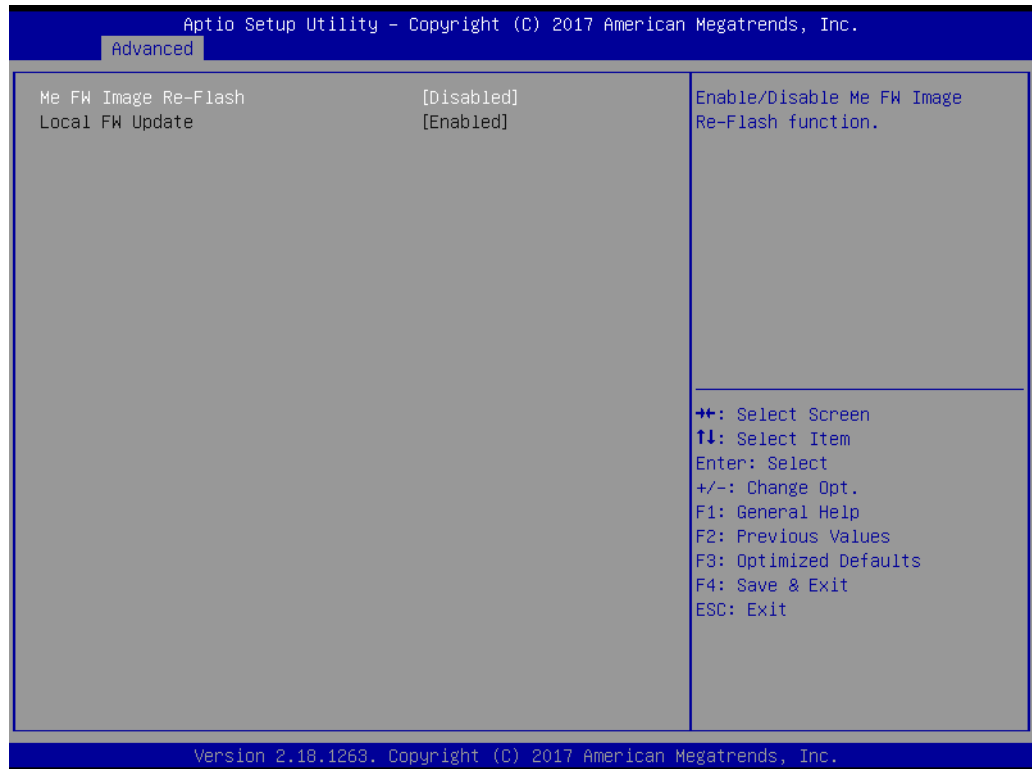

Figure 3.7 Firmware Update Configuration

- **Me FW Image Re-Flash**
Enable/Disable Me FW Image Re-Flash function

■ PTT Configuration

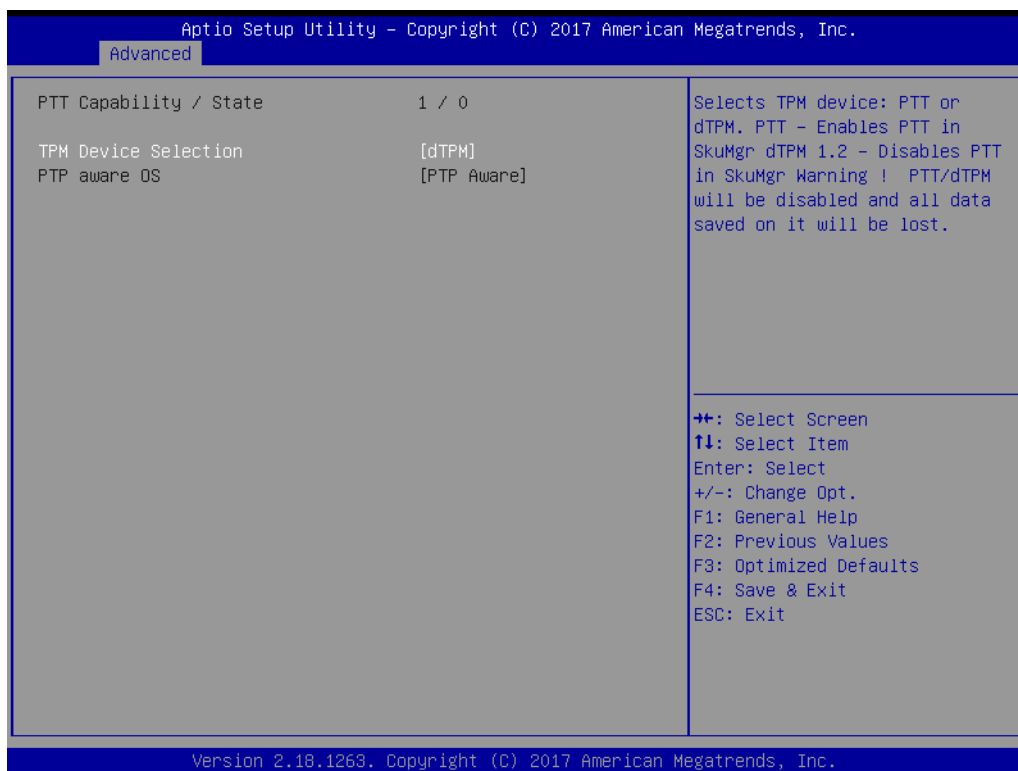

Figure 3.8 PTT Configuration

- **TPM Device Selection**
 Selects TPM device: PTT or dTPM.
 PTT- Enables PTT in SkuMgr
 dTPM 1.2- Disables PTT in SkuMgr Warning!
 PTT/dTPM will be disabled and all data saved on it will be lost.
- **PTP aware OS**
 Select whether or not the OS you will boot to will be PTP aware.

3.1.2.4 Trusted Computing

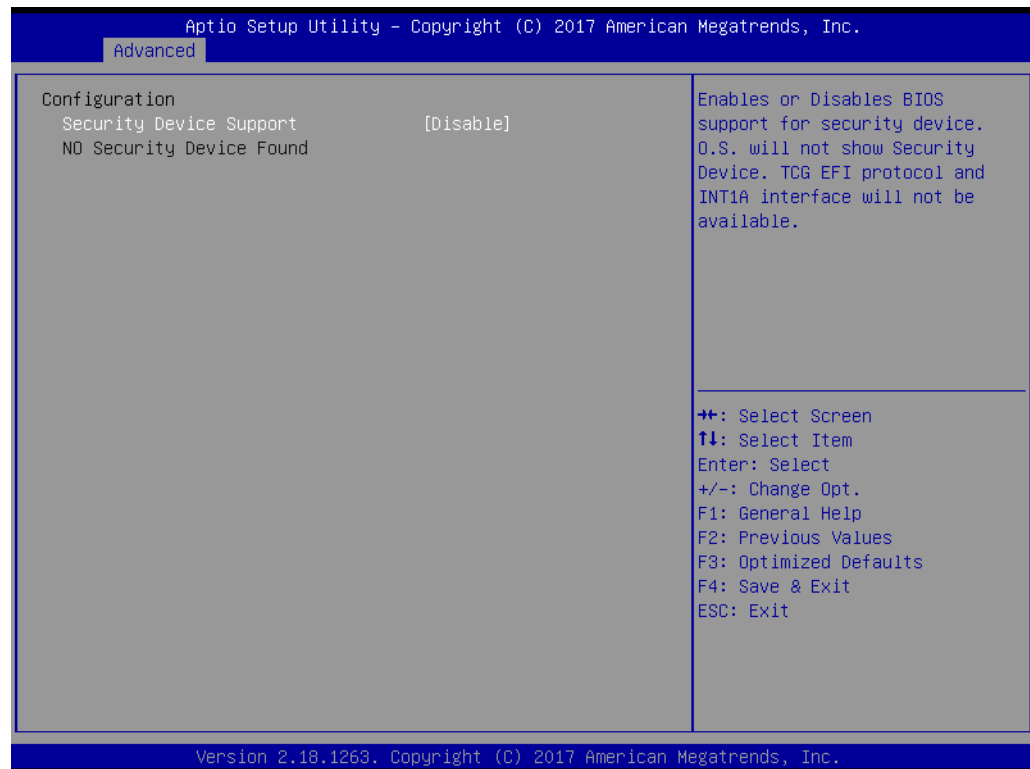

Figure 3.9 Trusted Computing

- **Security Device Support**

Enables or Disables BIOS support for security devices. OS will not show security device. TCG EFI protocol and INT1A interface will not be available.

3.1.2.5 ACPI Settings

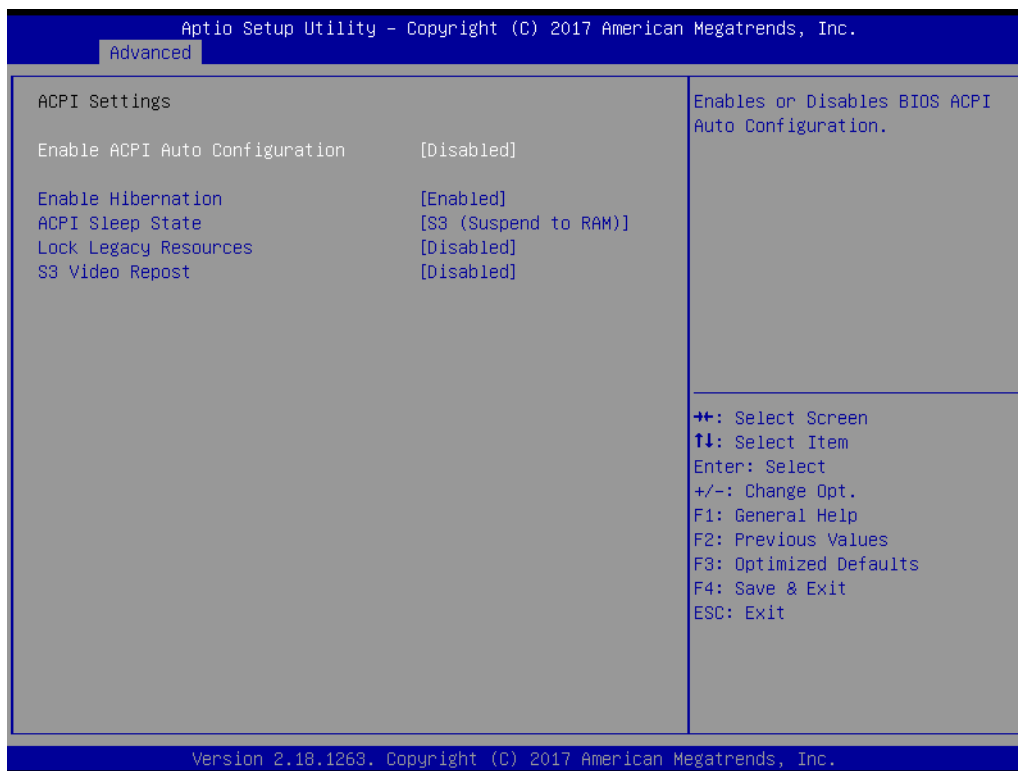

Figure 3.10 ACPI Settings

- **Enable ACPI Auto Configuration**
Enables or Disables BIOS ACPI Auto Configuration.
- **Enable Hibernation**
Enables or Disables System ability to Hibernate (OS/S4 Sleep State). This option may be not effective with some OS.
- **ACPI Sleep State**
Select the highest ACPI sleep state the system will enter when the SUSPEND button is pressed.
- **Lock Legacy Resources**
Enables or Disables Lock of Legacy Resources
- **S3 Video Repost**
Enables or Disables Lock of S3 Video Repost

3.1.2.6 iManager Configuration

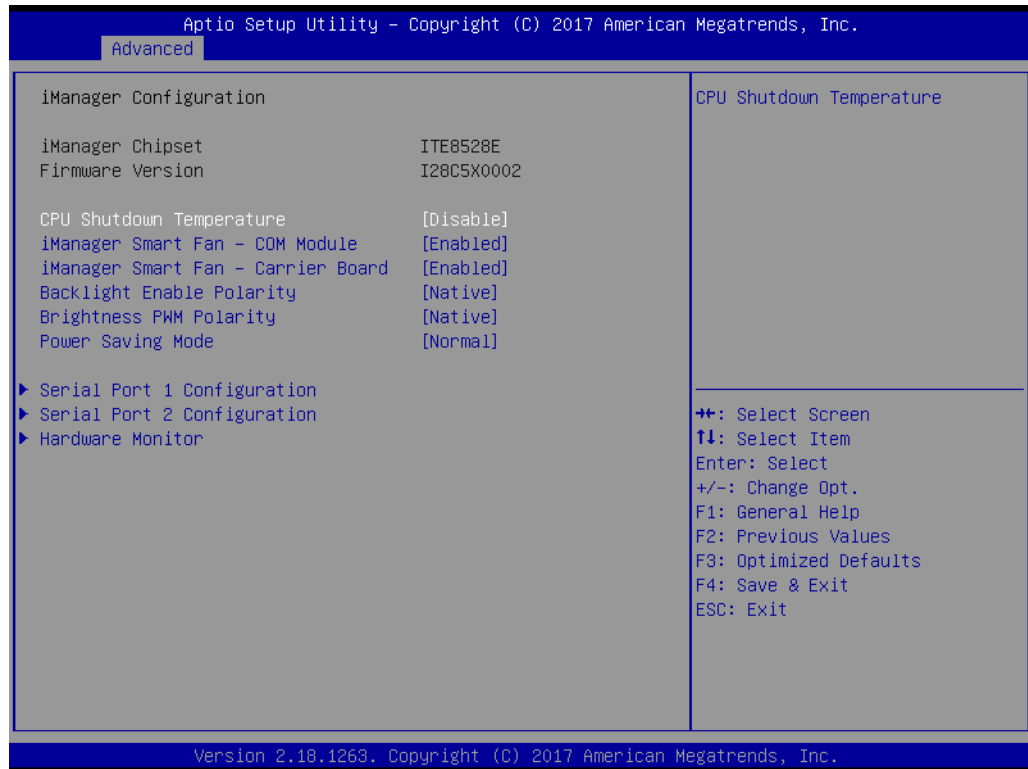

Figure 3.11 iManager Configuration

- **CPU Shutdown Temperature**
Enable/Disable CPU Shutdown Temperature.
- **iManager Smart Fan – COM Module**
Control iManager Smart FAN function.
- **iManager Smart Fan – Carrier Board**
Control iManager Smart FAN Carrier Board function.
- **Backlight Enable Polarity**
Switch Backlight Enable Polarity for Native or Invert
- **Brightness PWM Polarity**
Switch Backlight Control Brightness PWM Polarity for Native or Invert
- **Power Saving Mode**
Select Ite8528 Power Saving Mode
- **Serial Port 1 Configuration**
Set Parameters of Serial Port 1 (COMA)
- **Serial Port 2 Configuration**
Set Parameters of Serial Port 2 (COMB)
- **Hardware Monitor**
Monitor hardware status

■ Serial Port 1 Configuration

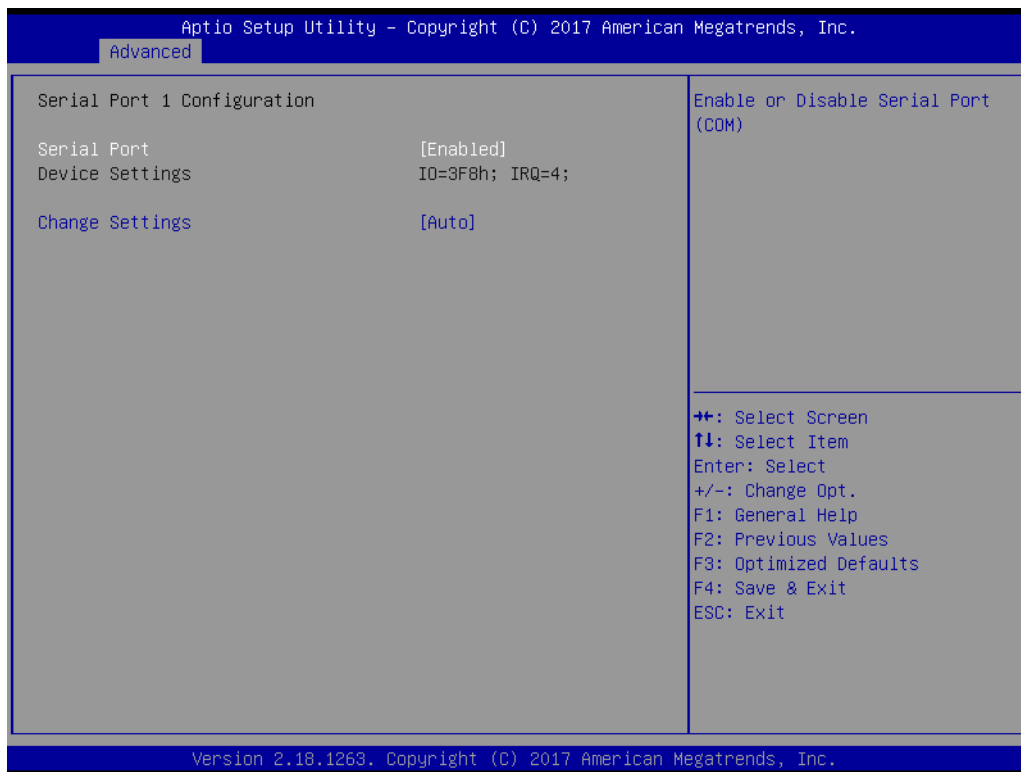

Figure 3.12 Serial Port 1 Configurations

- **Serial Port**
Enable or disables serial port (COM).
- **Change Settings**
Select an optimal setting for Super IO device.

■ Serial Port 2 Configuration



Figure 3.13 Serial Port 2 Configurations

- **Serial Port**
Enable or disables. serial port (COM).
- **Change Settings**
Selects an optimal setting for Super IO device.

■ Hardware Monitor

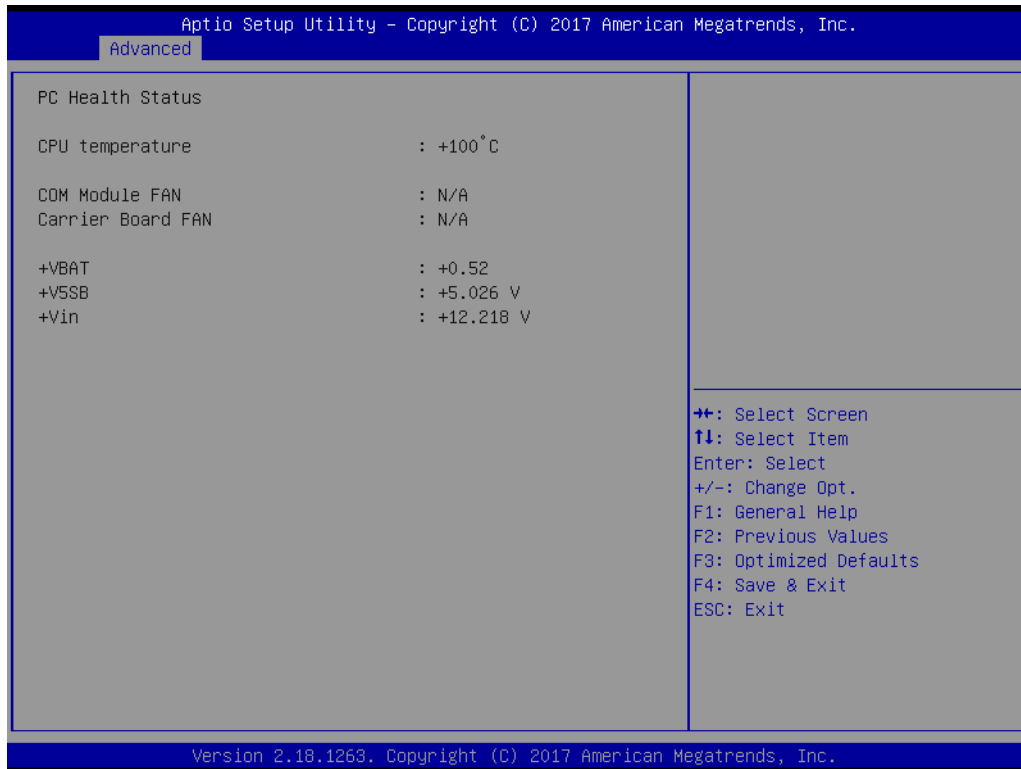

Figure 3.14 Hardware Monitor

– Hardware Monitor Information

This item shows Hardware information parameters.

3.1.2.7 W83627DHGSEC Super IO Configuration



Figure 3.15 W83627DHGSEC Super IO Configuration

- **Serial Port 3 Configuration**
Set Parameters of Serial Port 3
- **Serial Port 4 Configuration**
Set Parameters of Serial Port 4
- **Parallel Port Configuration**
Set Parameters of Parallel Port (LPT/LPTE)

■ Serial Port 3 Configuration

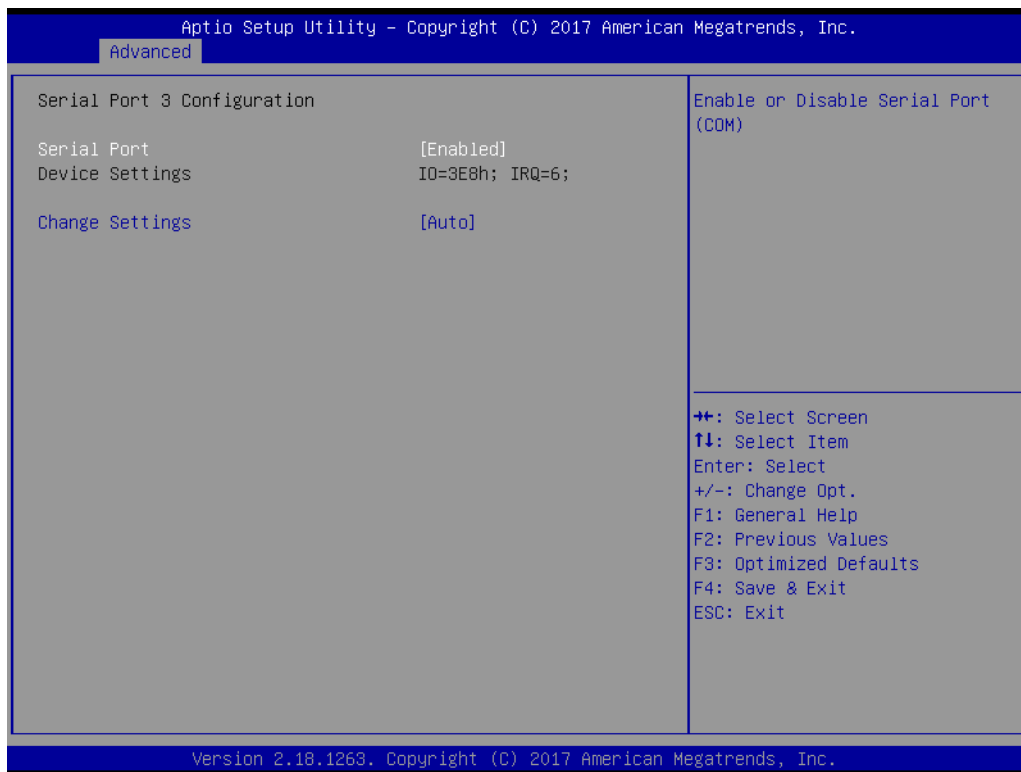

Figure 3.16 Serial Port 3 Configurations

- **Serial Port**
Enable or disables serial port (COM).
- **Change Settings**
Select an optimal setting for Super IO device.

■ Serial Port 4 Configuration

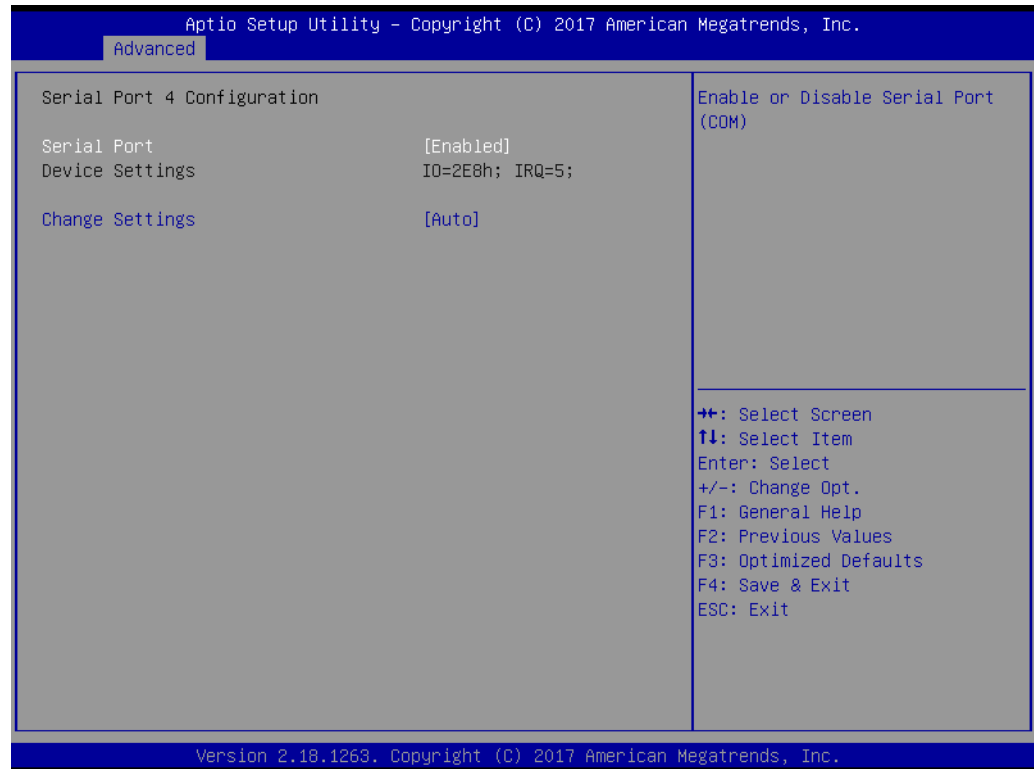

Figure 3.17 Serial Port 4 Configurations

- **Serial Port**
Enable or disables. serial port (COM).
- **Change Settings**
Selects an optimal setting for Super IO device.

■ Parallel Port Configuration

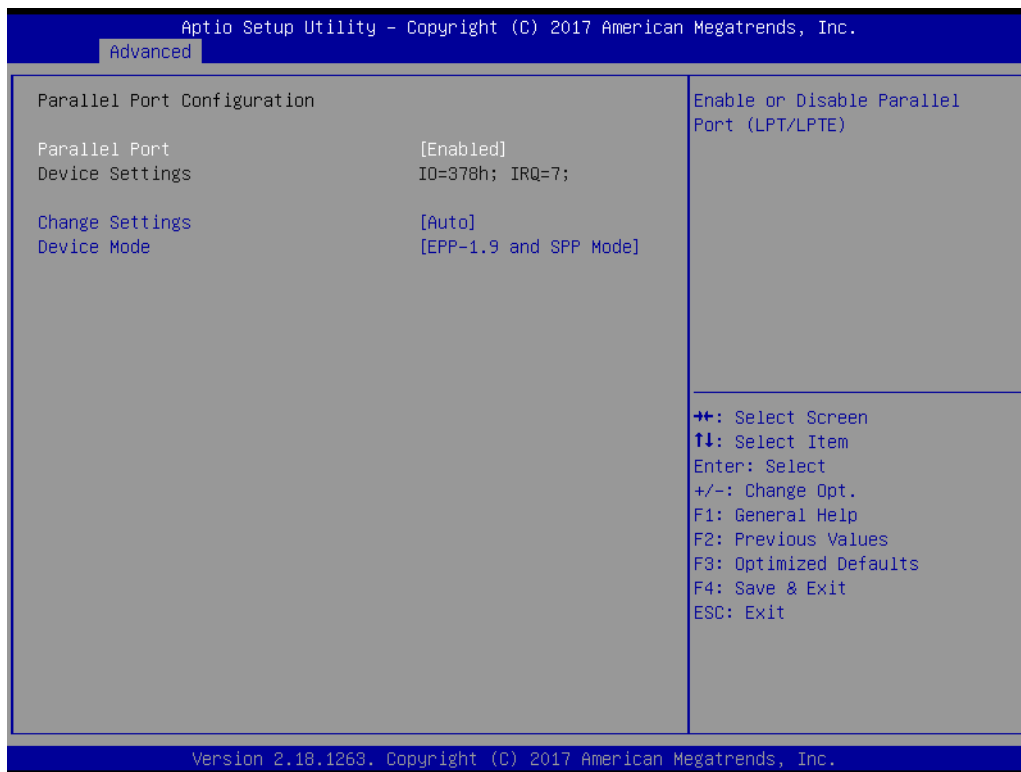

Figure 3.18 Parallel Port Configuration

- **Parallel Port**
Enable or Disable Parallel Port (LPT/LPTE)
- **Change Settings**
Select an optimal setting for Super IO device.
- **Device Mode**
Change the Printer Port mode.

3.1.2.8 Serial Port Console Redirection

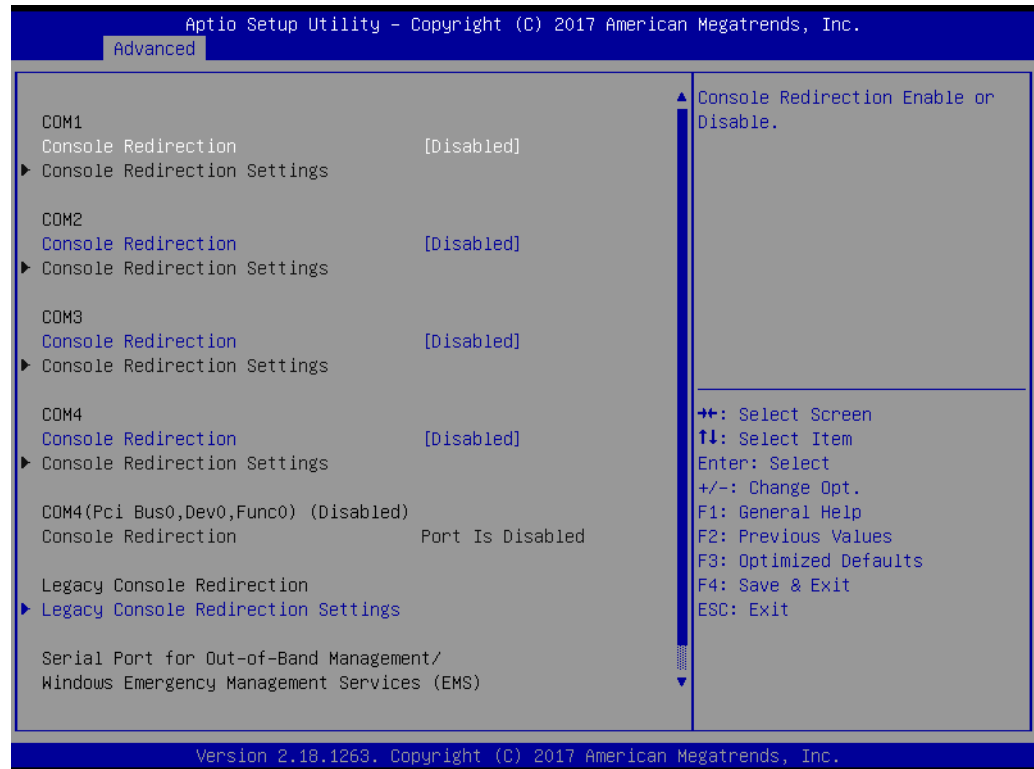

Figure 3.19 Serial Port Console Redirection

- **COM1 Console Redirection**
Console Redirection Enable or Disable
- **COM2 Console Redirection**
Console Redirection Enable or Disable
- **COM3 Console Redirection**
Console Redirection Enable or Disable
- **COM4 Console Redirection**
Console Redirection Enable or Disable
- **Legacy Console Redirection Settings**
Legacy Console Redirection Settings
- **Console Redirection**
Console Redirection Enable or Disable

■ Legacy Console Redirection Settings

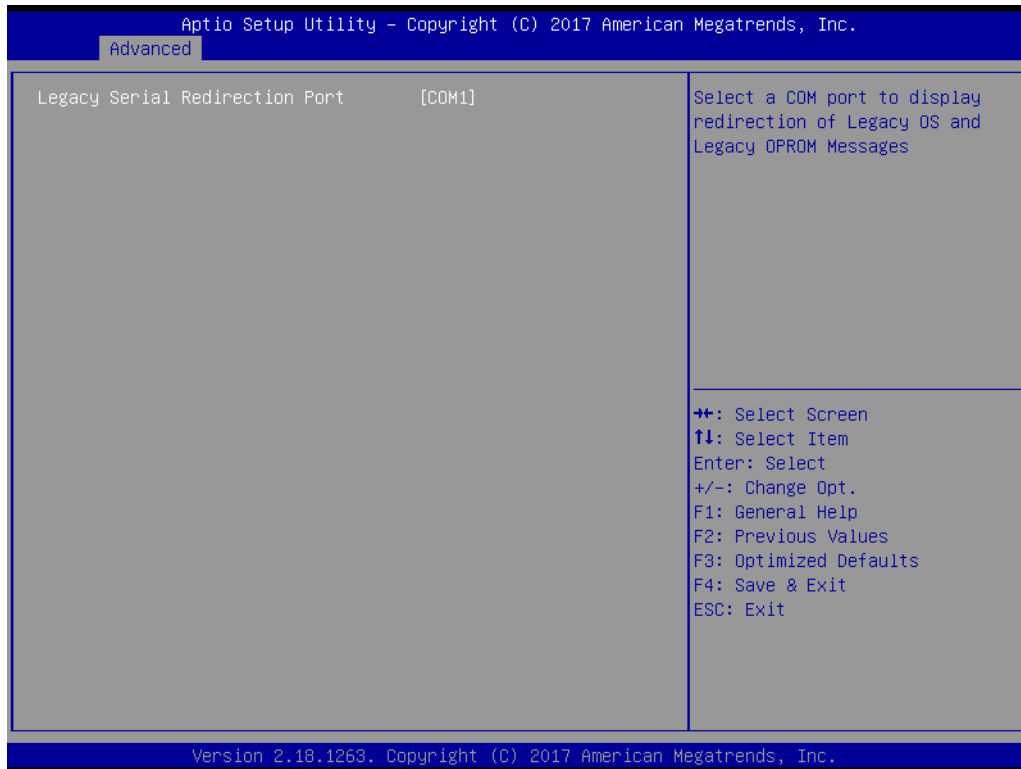

Figure 3.20 Legacy Console Redirection Settings

- **Legacy Serial Redirection Port**
Select a COM port to display redirection of Legacy OS and Legacy OPRM Messages

3.1.2.9 Network Stack Configuration



Figure 3.21 Network Stack Configuration

- **Network Stack**
Enable/Disable UEFI Network Stack.

3.1.2.10 CSM Configuration

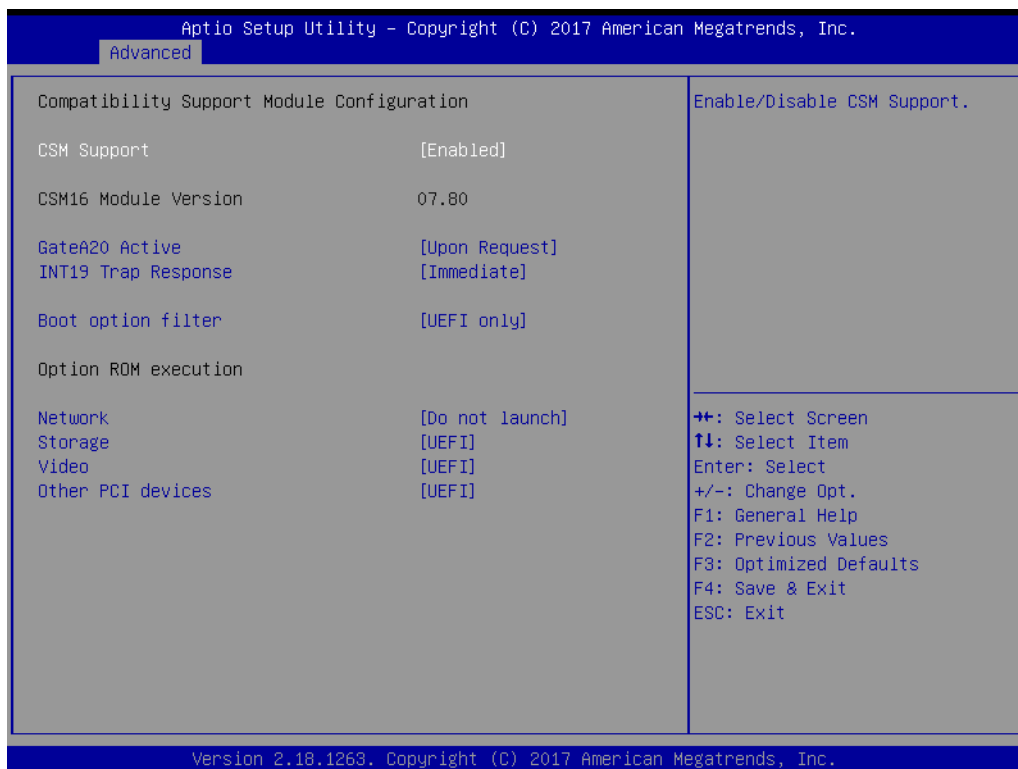

Figure 3.22 CSM Configuration

- **CSM Support**
Enable/Disable CSM support.
- **GateA20 Active**
UPON Request- GA20 can be disabled using BIOS services. Do not allow disabling GA20; this option is useful when any RT code is executed above 1MB.
- **INT19 Trap Response**
BIOS reaction on INT19 trapping by option ROM:
IMMEDIATE – execute the trap right away;
POSTPONED – execute the trap during legacy boot.
- **Boot option filter**
This option controls legacy/UEFI ROMs priority.
- **Network**
Controls the execution of UEFI and legacy PXE OpROM.
- **Storage**
Controls the execution of UEFI and legacy storage OpROM.
- **Video**
Controls the execution of UEFI and legacy video OpROM.
- **Other PCI devices**
Determines OpROM execution policy for devices other than network, storage, or video.

3.1.2.11 NVMe Configuration

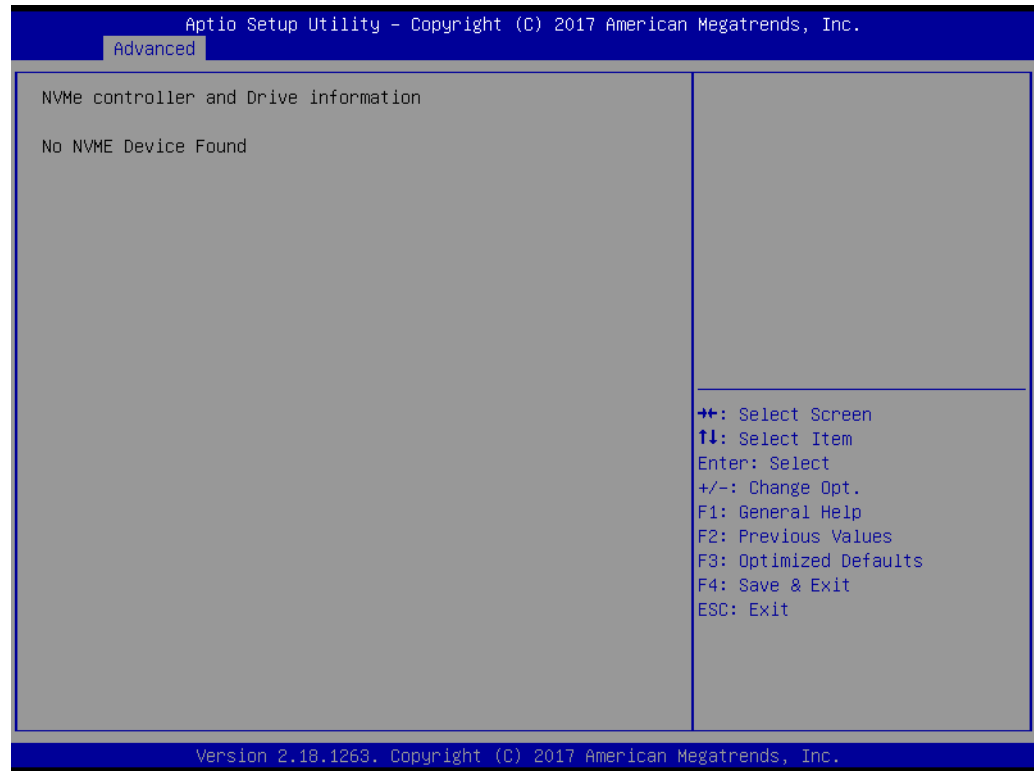

Figure 3.23 NVMe Configuration

- **NVMe Configuration**
NVMe controller and driver information

3.1.2.12 USB Configuration

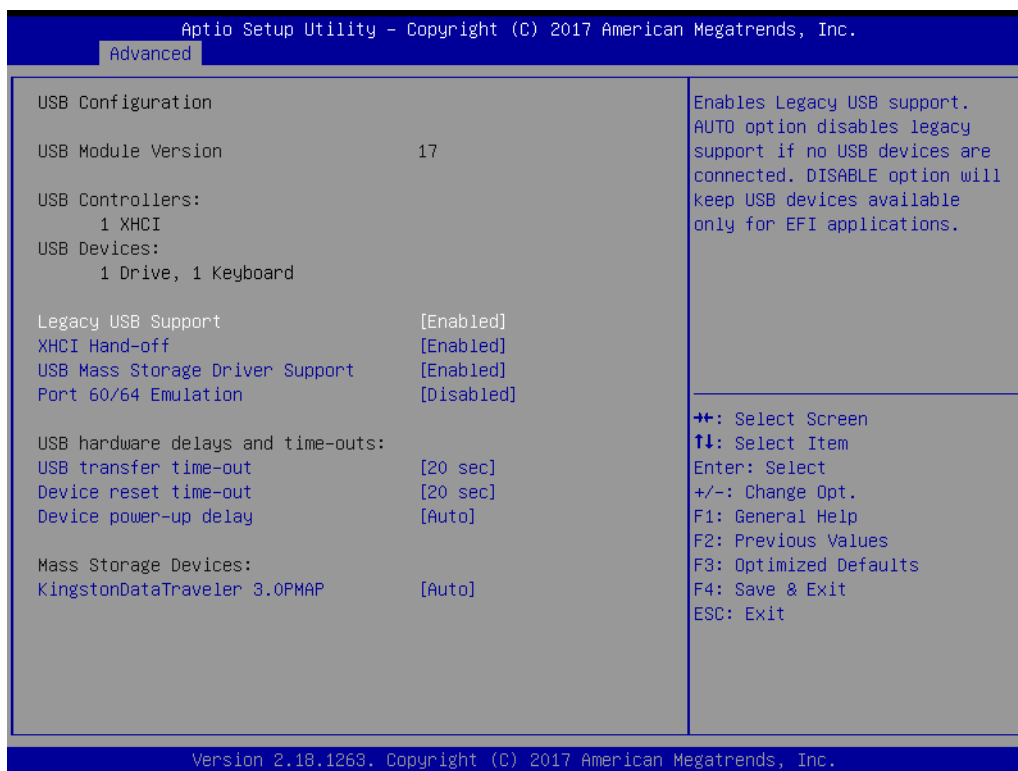

Figure 3.24 USB Configuration

- **Legacy USB Support**
Enables Legacy USB support. Auto option disables legacy support if no USB devices are connected. Disable option will keep USB devices available only for EFI applications.
- **XHCI Hand-off**
This is a workaround for OS without XHCI ownership change should be claimed by XHCI driver.
- **USB Mass Storage Driver Support**
Enable/Disable USB Mass Storage Driver Support.
- **Port 60/64 Emulation**
Enables I/O port 60h/64h emulation support. This should be enabled for the complete USB keyboard legacy support for non-USB aware OS.
- **USB transfer time-out**
The time-out value for Control, Bulk, and Interrupt transfers.
- **Device reset time-out**
USB mass storage device Start Unit command time-out.
- **Device power-up delay**
Maximum time the device will take before it properly reports itself to the Host Controller.
'Auto' uses default value: for a Root port it is 100ms, for a Hub port the delay is taken from Hub descriptor.

3.1.3 Chipset

Select the chipset tab from the SOM-6898 setup screen to enter the chipset BIOS Setup screen. You can display a chipset BIOS setup option by highlighting it using the <Arrow> keys. All Plug and Play BIOS setup options are described in this section. The Plug and Play BIOS Setup screen is shown below.

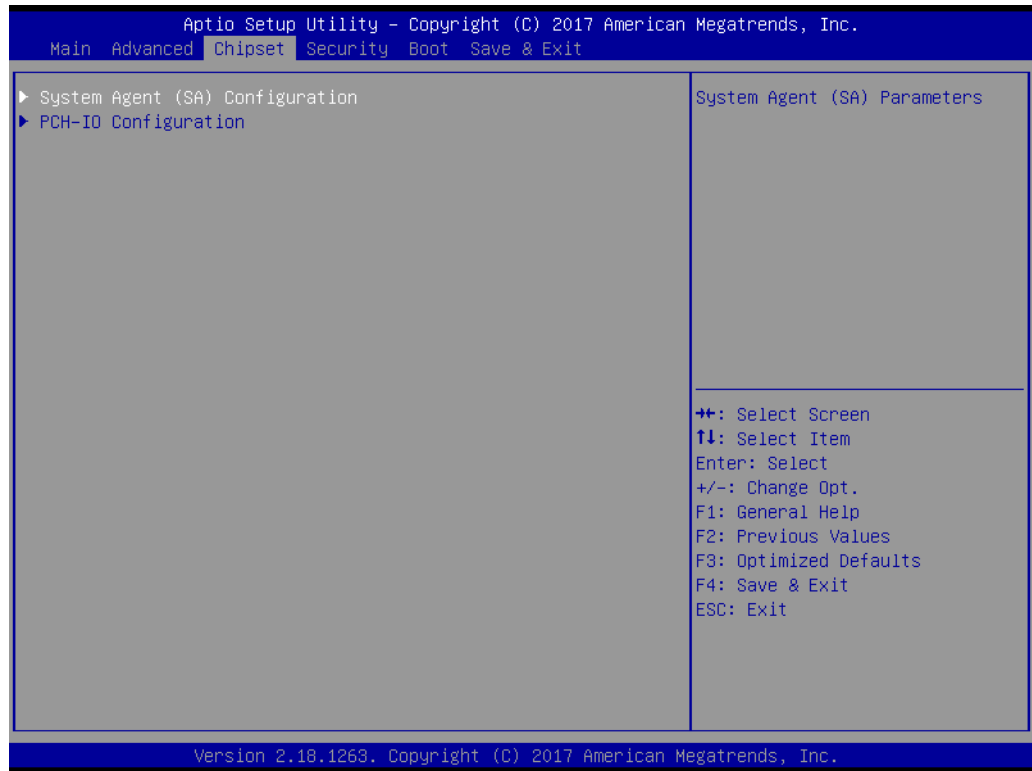

Figure 3.25 Chipset Setup

- **System Agent (SA) Configuration**
System Agent (SA) Parameters.
- **PCH-IO Configuration**
PCH Parameters.

3.1.3.1 System Agent (SA) Configuration

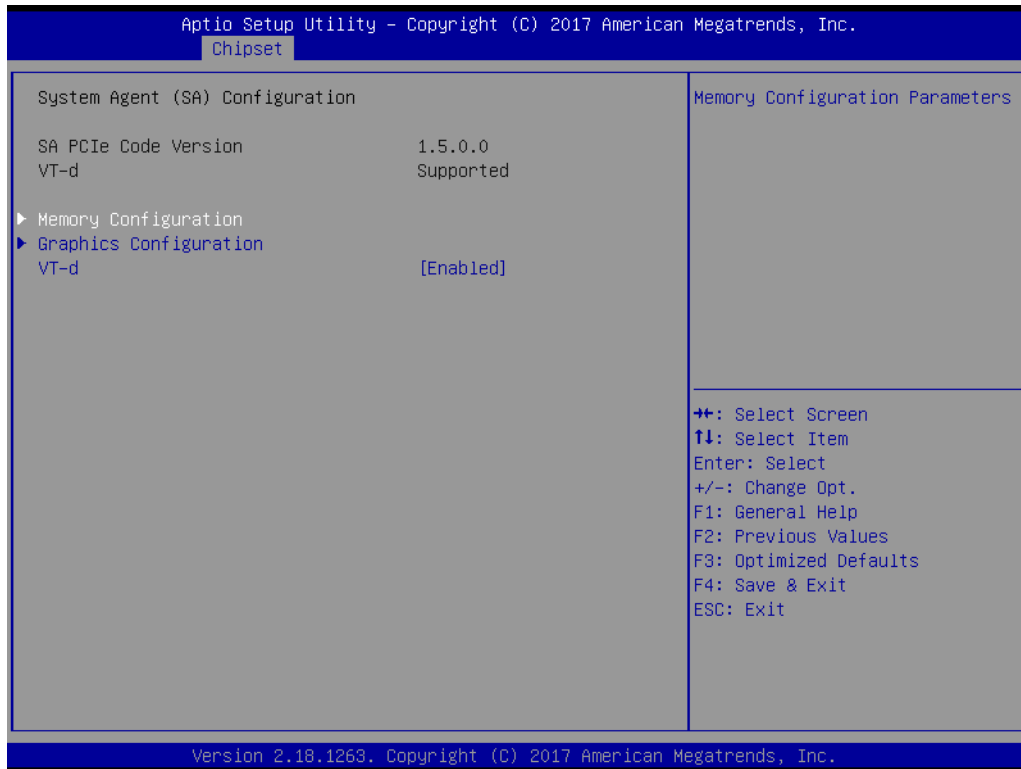

Figure 3.26 System Agent (SA) Configuration

- **Memory Configuration**
Memory Configuration Parameters
- **Graphics Configuration**
Graphics Configuration Parameters
- **VT-d**
VT-d capability.

■ Memory Configuration

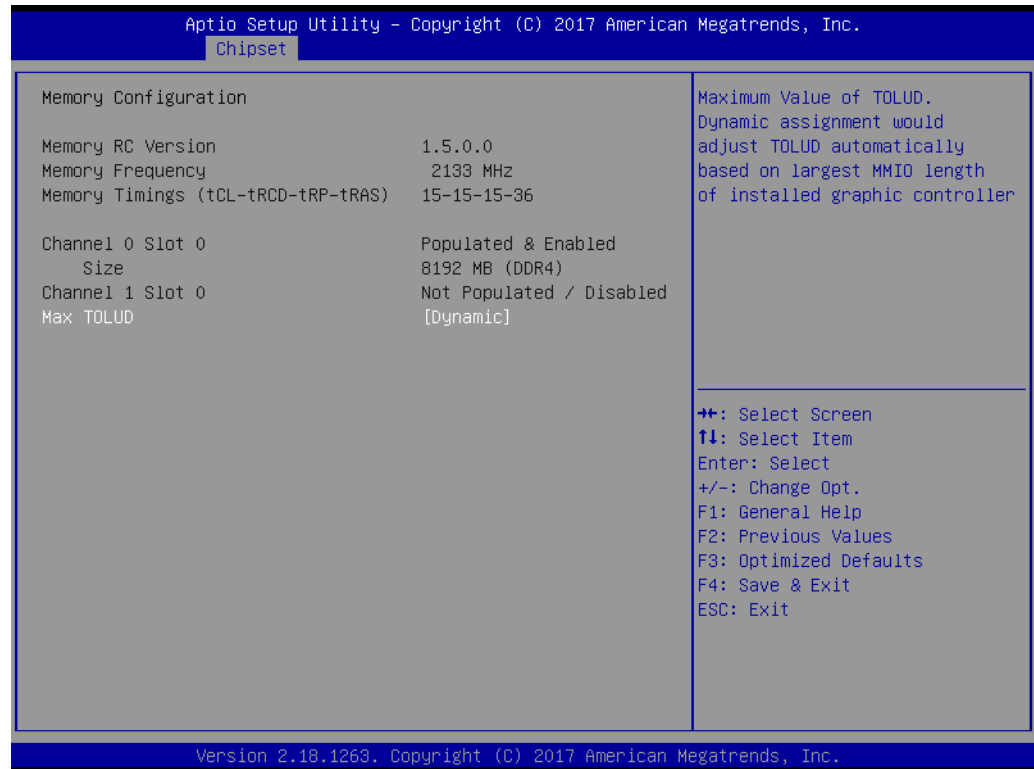

Figure 3.27 Memory Configuration

– Max TOLUD

Maximum Value of TOLUD. Dynamic assignment would adjust TOLUD automatically based on largest MMIO length of installed graphic controller.

■ Graphics Configuration

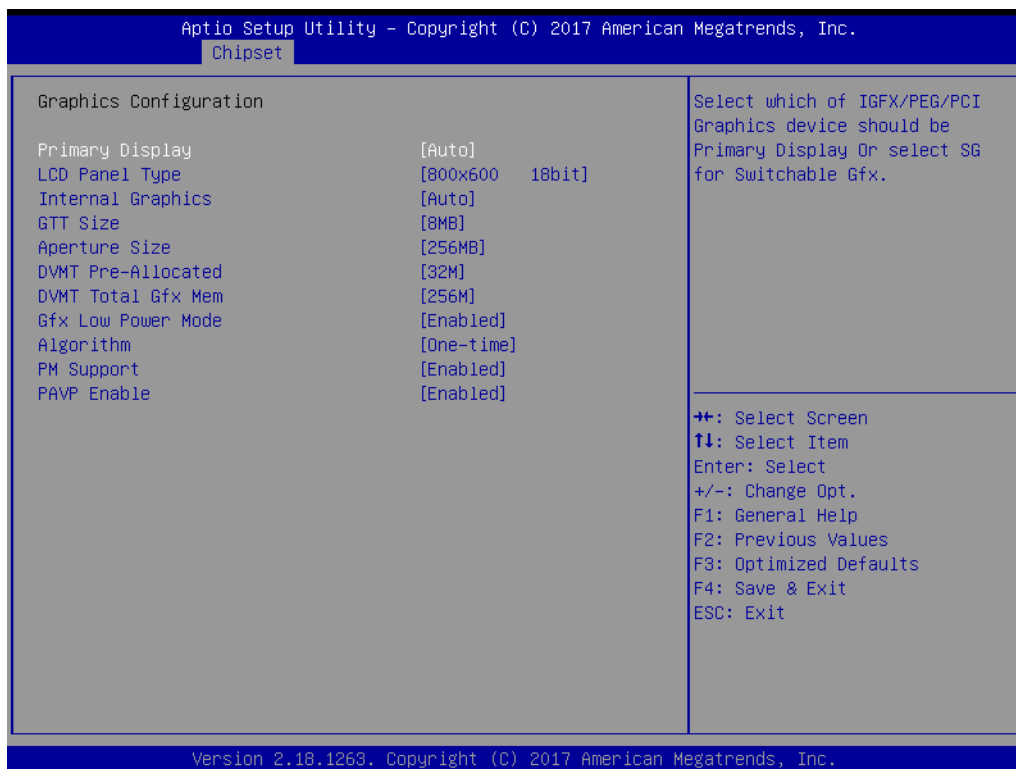

Figure 3.28 Graphics Configuration

- **Primary Display**
Select which of IGFX/PEG/PCI Graphics device should be Primary Display or select SG for Switchable Gfx.
- **LCD Panel Type**
Select LCD panel used by Internal Graphics Device by selecting the appropriate setup item.
- **Internal Graphics**
Keep IGFX enabled based on the setup options.
- **GTT Size**
Select the GTT size.
- **Aperture Size**
Select the Aperture Size
Note: Above 4GB MMIO BIOS assignment is automatically enabled when selecting 2048MB aperture. To use this feature please disable CSM support.
- **DVMT Pre-Allocated**
Select DVMT 5.0 Pre-Allocated (Fixed) Graphics Memory size used by the Internal Graphics Device.
- **DVMT Total Gfx Mem**
Select DVMT 5.0 Total Graphic Memory size used by the Internal Graphics Device.
- **Gfx Low Power Mode**
This option is applicable for SFF only.
- **Algorithm**
HDCP Re-encryption Flow.
- **PM Support**
Enable/Disable PM Support.
- **PAVP Enable**
Enable/Disable PAVP.

3.1.3.2 PCH-IO Configuration

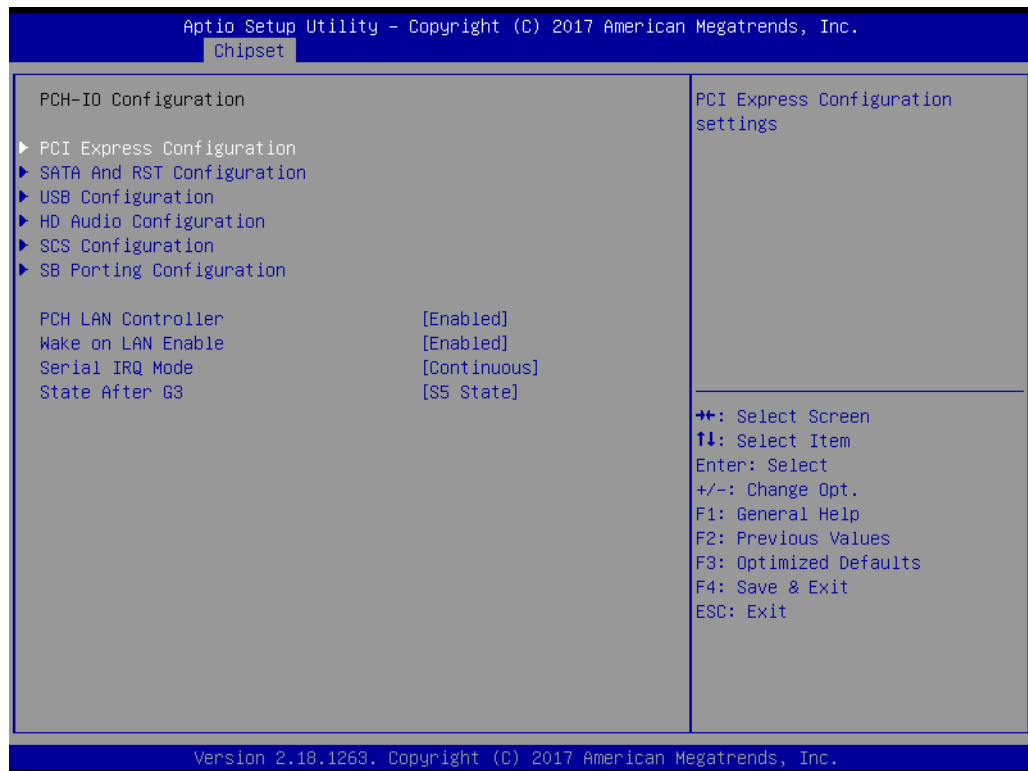

Figure 3.29 PCH-IO Configuration

- **PCI Express Configuration**
PCI Express configuration settings.
- **SATA And RST Configuration**
SATA Device Options Settings
- **USB Configuration**
USB Configuration settings
- **HD Audio Configuration**
HD Audio Subsystem Configuration Settings
- **SCS Configuration**
Storage and Communication Subsystem (SCS) Configuration
- **SB Porting Configuration**
SB Porting Configuration
- **PCH LAN Controller**
Enable/Disable onboard NIC.
- **Wake on LAN Enable**
Enable/Disable integrated LAN to wake the system.
- **Serial IRQ Mode**
Configure Serial IRQ Mode
- **State After G3**
Specify what state to go to when power is re-applied after a power failure (G3 state).

■ PCI Express Configuration

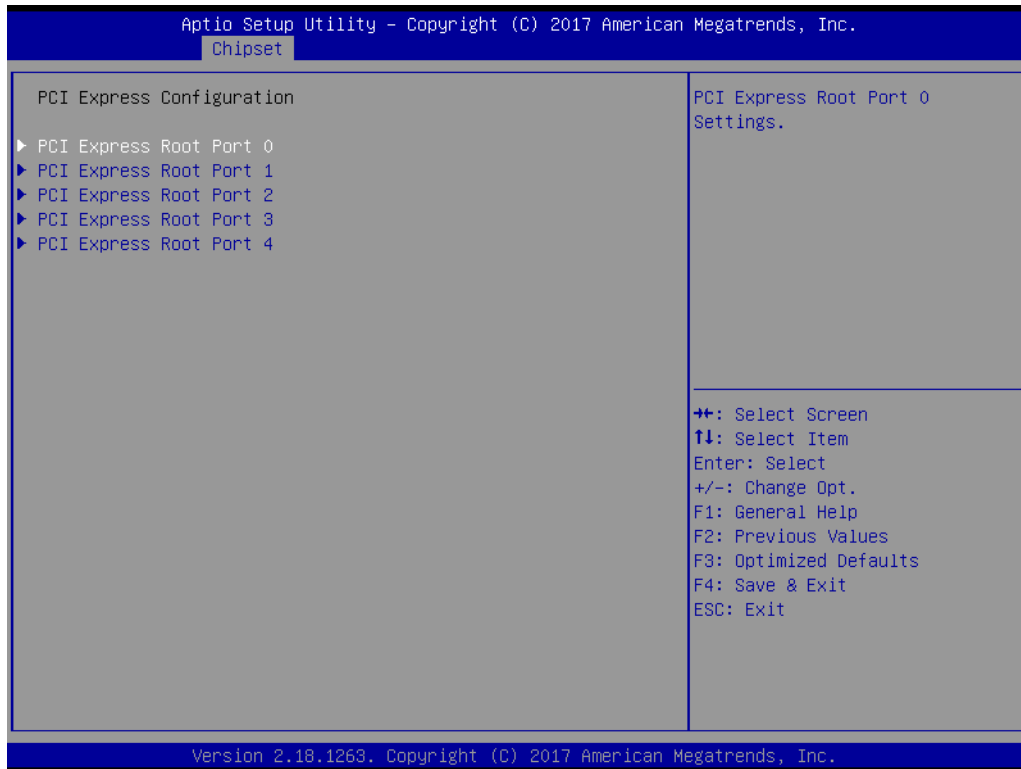

Figure 3.30 PCI Express Configuration

- **PCI Express Root Port 0**
PCI Express Root Port 0 settings.
- **PCI Express Root Port 1**
PCI Express Root Port 1 settings.
- **PCI Express Root Port 2**
PCI Express Root Port 2 settings.
- **PCI Express Root Port 3**
PCI Express Root Port 3 settings.
- **PCI Express Root Port 4**
PCI Express Root Port 4 settings.

– PCI Express Root Port 0 Configuration

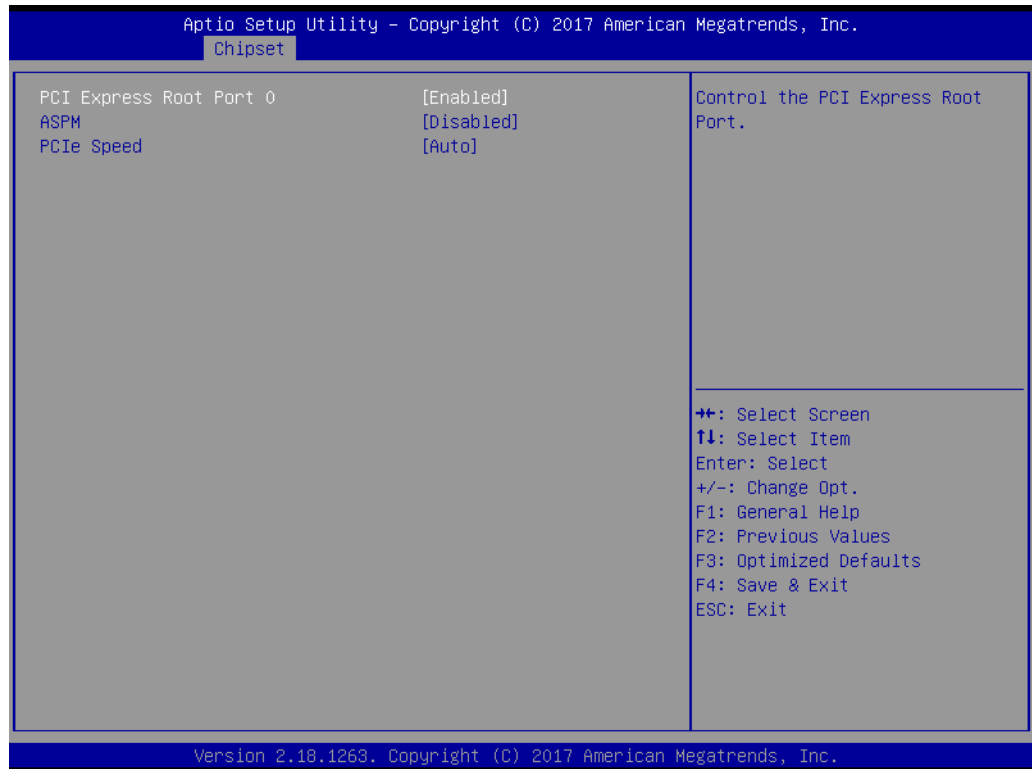

Figure 3.31 PCI Express Root Port 0 Configuration

PCI Express Root Port 0

Control the PCI Express Root Port.

ASPM

Set the ASPM level:

Force L0s – Force all links to L0s state.

Auto – BIOS auto configure

Disable – disable ASPM.

PCIe Speed

Select PCI Express port speed.

– PCI Express Root Port 1 Configuration

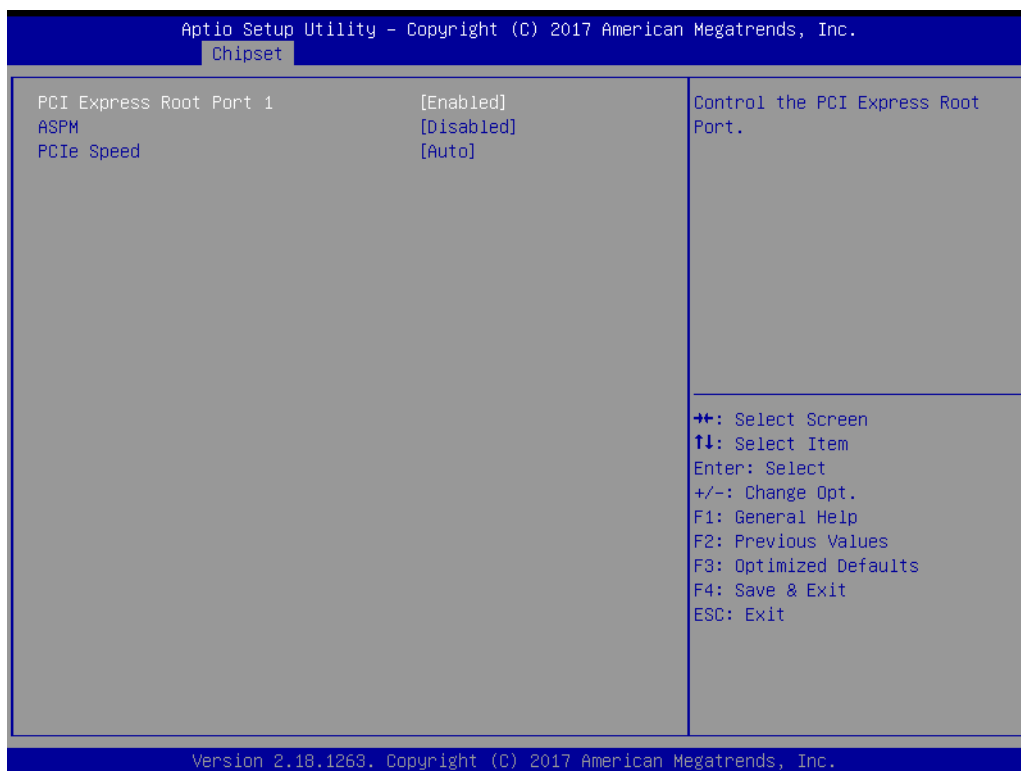

Figure 3.32 PCI Express Root Port 1 Configuration

PCI Express Root Port 1

Control the PCI Express Root Port.

ASPM

Set the ASPM level:

Force L0s – Force all links to L0s state.

Auto – BIOS auto configure

Disable – disable ASPM.

PCIe Speed

Select PCI Express port speed.

– PCI Express Root Port 2 Configuration

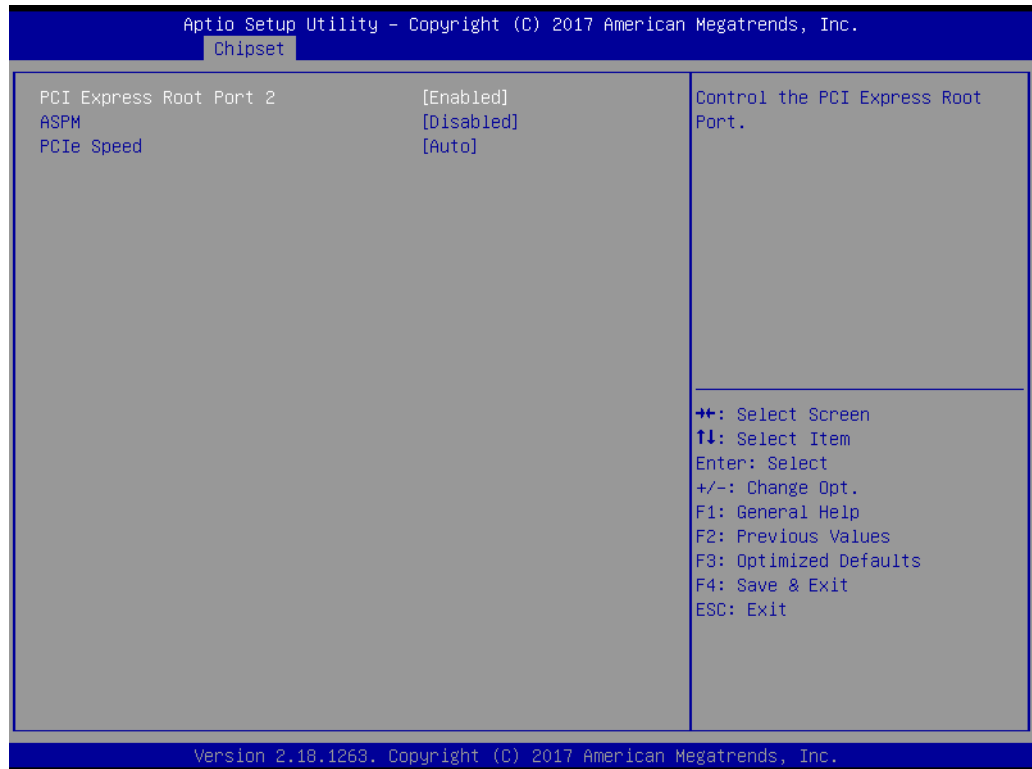

Figure 3.33 PCI Express Root Port 2 Configuration

PCI Express Root Port 2

Control the PCI Express Root Port.

ASPM

Set the ASPM level:

Force L0s – Force all links to L0s state.

Auto – BIOS auto configure

Disable – disable ASPM.

PCIe Speed

Select PCI Express port speed.

– PCI Express Root Port 3 Configuration

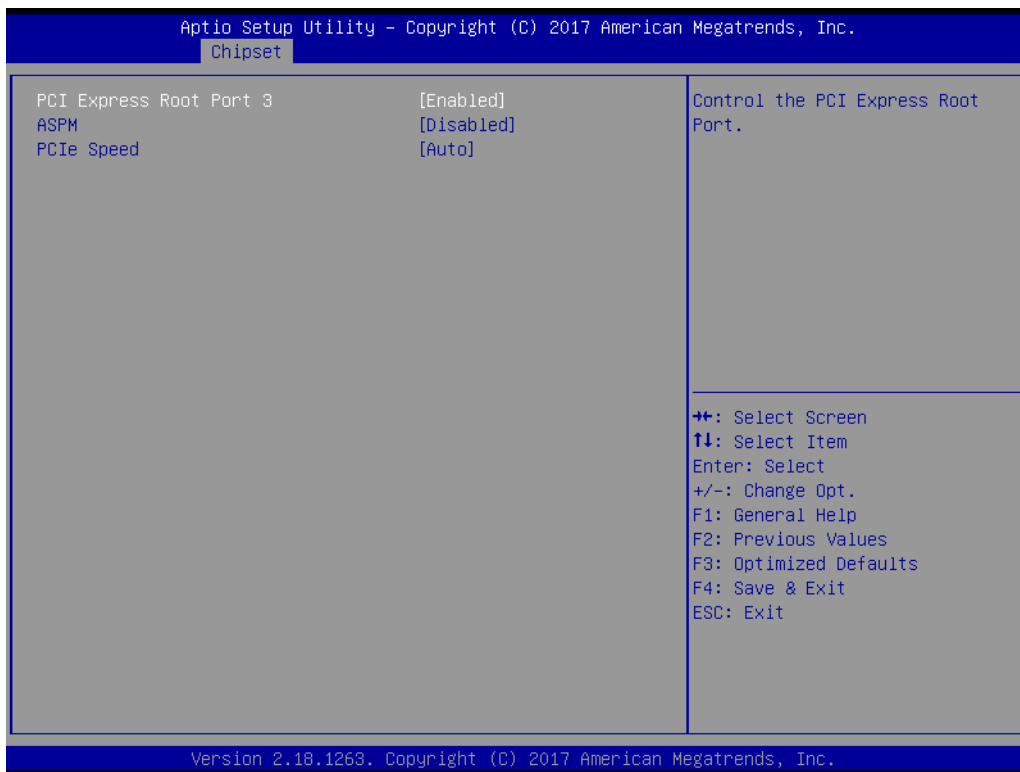

Figure 3.34 PCI Express Root Port 3 Configuration

PCI Express Root Port 3

Control the PCI Express Root Port.

ASPM

Set the ASPM level:

Force L0s – Force all links to L0s state.

Auto – BIOS auto configure

Disable – disable ASPM.

PCIe Speed

Select PCI Express port speed.

– PCI Express Root Port 4 Configuration

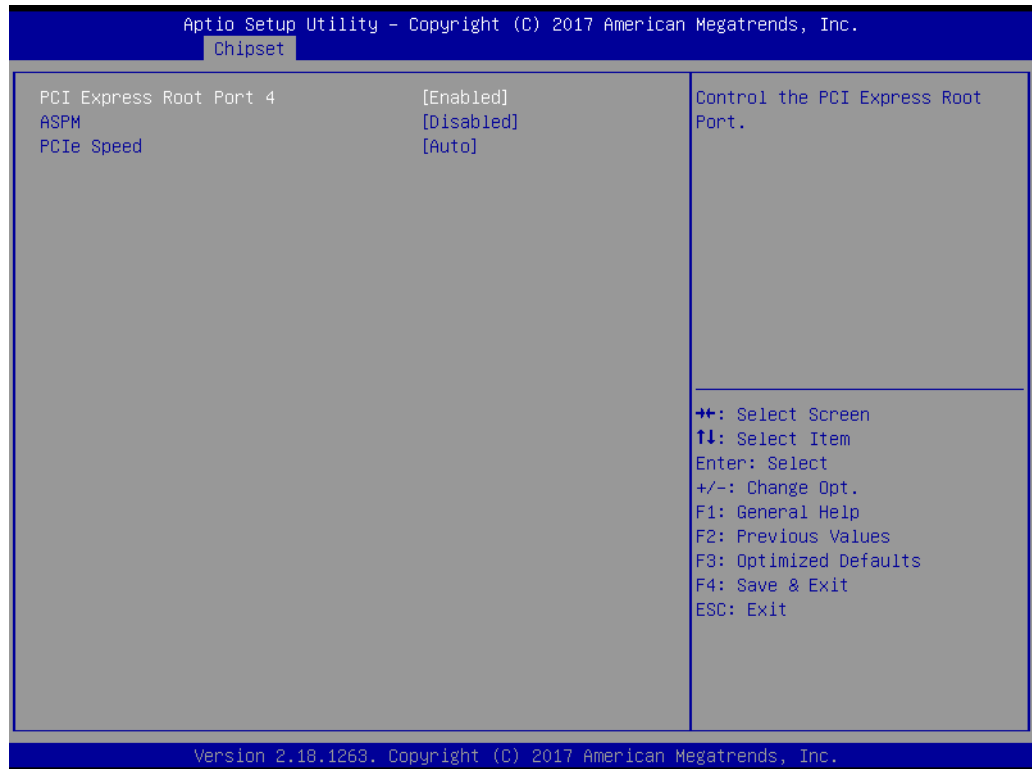

Figure 3.35 PCI Express Root Port 4 Configuration

PCI Express Root Port 4

Control the PCI Express Root Port.

ASPM

Set the ASPM level:

Force L0s – Force all links to L0s state.

Auto – BIOS auto configure

Disable – disable ASPM.

PCIe Speed

Select PCI Express port speed.

■ SATA And RST Configuration

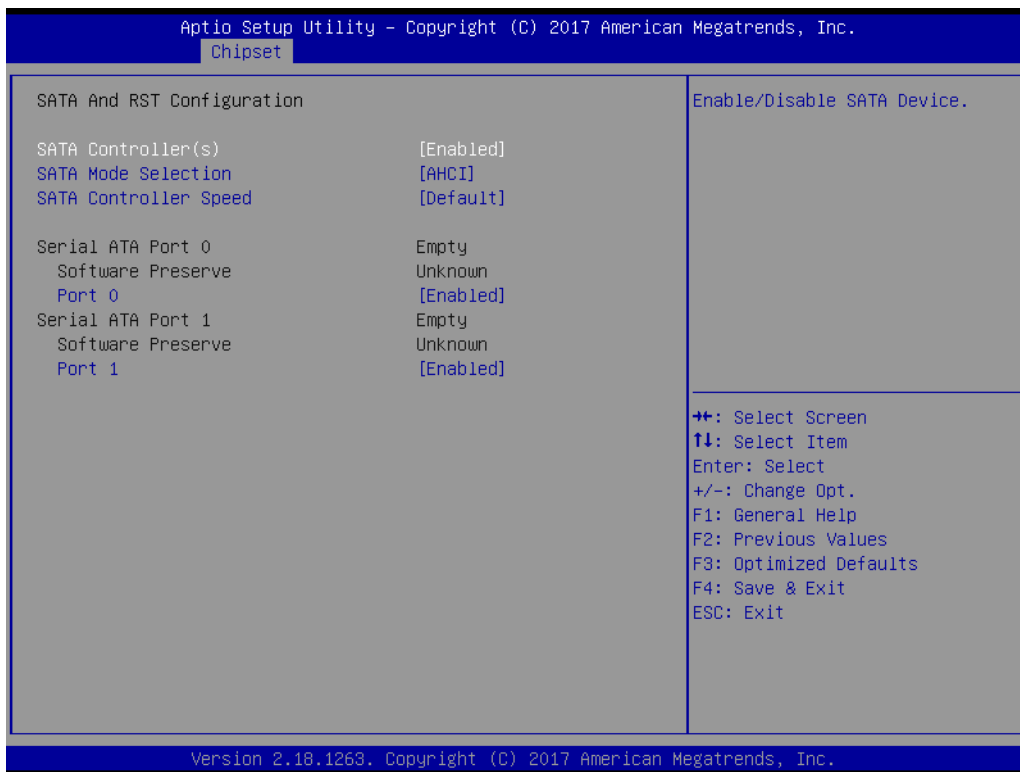

Figure 3.36 SATA And RST Configuration

- **SATA Controller(s)**
Enable/Disable SATA Device
- **SATA Mode Selection**
Determines how SATA controller(s) operate.
- **SATA Controller Speed**
Indicates the maximum speed the SATA controller can support.
- **Port 0**
Enable or Disable SATA port
- **Port 1**
Enable or Disable SATA port

■ USB Configuration



Figure 3.37 USB Configuration

– XHCI Disable Compliance Mode

Options to disable Compliance Mode.

Default is False to not disable Compliance Mode. Set TRUE to disable Compliance Mode.

■ HD Audio Configuration

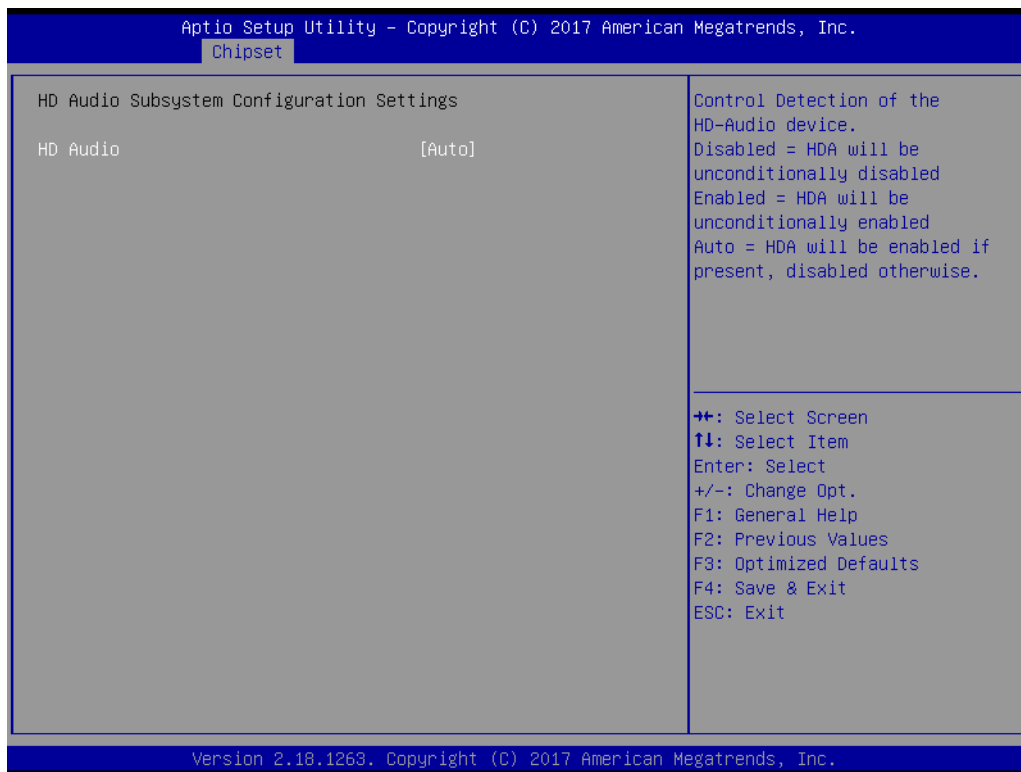

Figure 3.38 HD Audio Configuration

– HD Audio

Control Detection of the HD-Audio device.

Disabled= HDA will be unconditionally disabled

Enabled= HDA will be unconditionally enabled

Auto= HDA will be enabled if present, disabled otherwise.

■ SCS Configuration

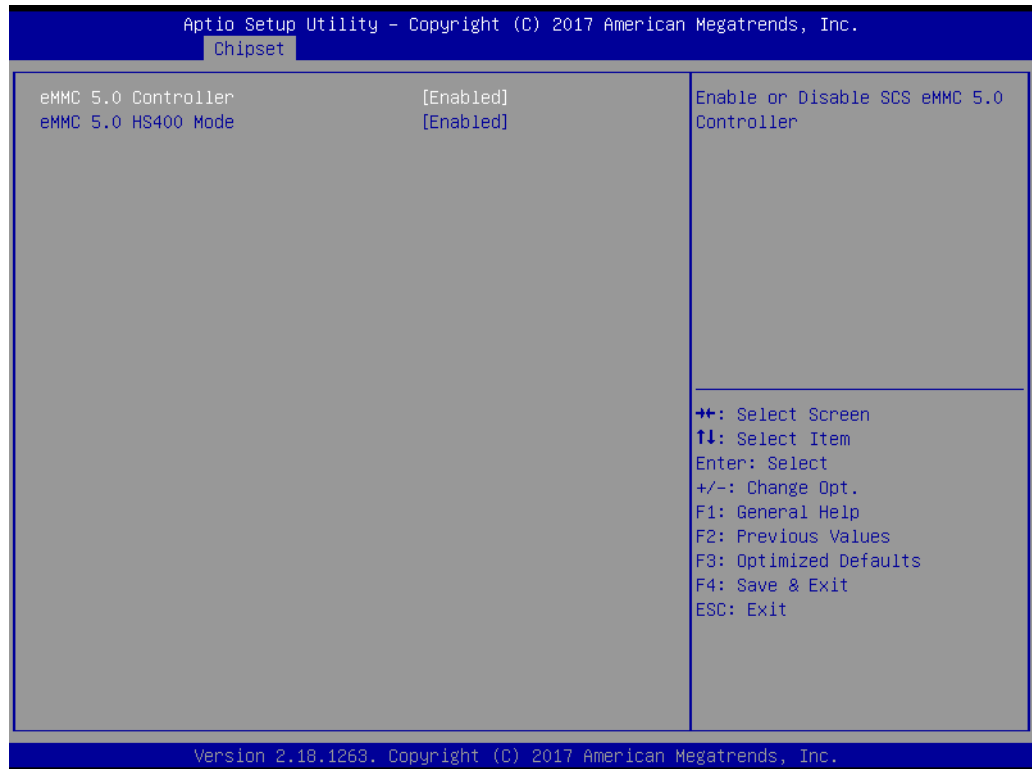

Figure 3.39 SCS Configuration

- **eMMC 5.0 Controller**
Enable or Disable SCS eMMC 5.0 Controller
- **eMMC 5.0 HS400 Mode**
Enable or Disable SCS eMMC 5.0 HS400 Controller

■ SB Porting Configuration

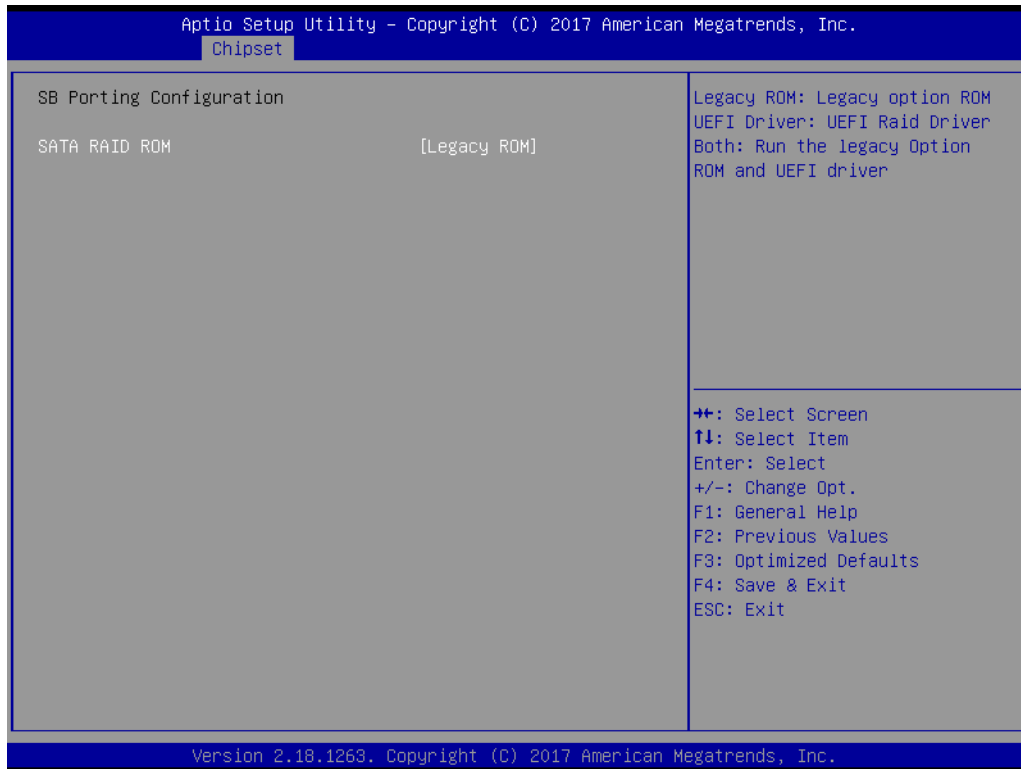

Figure 3.40 SB Porting Configuration

– SATA RAID ROM

Legacy ROM: Legacy option ROM

UEFI Driver: UEFI Raid Driver

Both: Run the legacy Option ROM and UEFI driver.

3.1.4 Security Setting

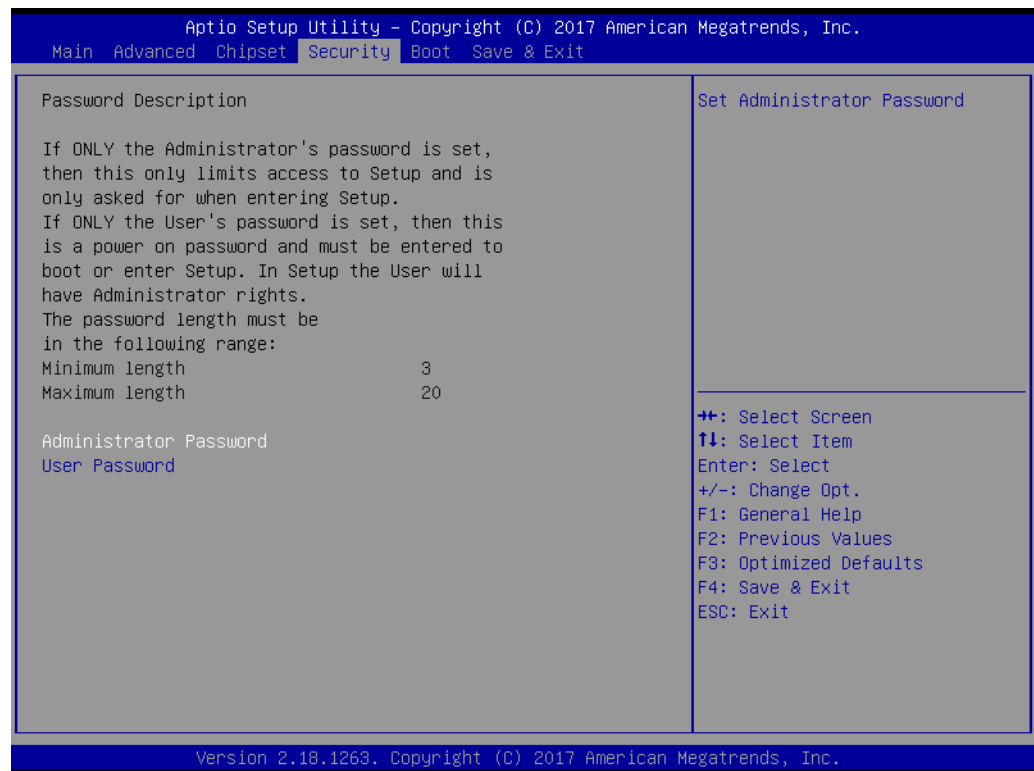

Figure 3.41 Security Setup

Select Security Setup from the SOM-6898 Setup main BIOS setup menu. All Security Setup options, such as password protection is described in this section. To access the sub menu for the following items, select the item and press <Enter>:

Change Administrator / User Password: Select this option and press <ENTER> to access the sub menu, and then type in the password.

3.1.5 Boot Settings



Figure 3.42 Boot Settings

- **Setup Prompt Timeout**
This item allows users to select the number of seconds to wait for setup activation key.
Number of seconds to wait for setup activation key.
65535(0xFFFF) means indefinite waiting.
- **Bootup NumLock State**
Select the keyboard NumLock state
- **Quiet Boot**
Enable/Disables Quiet Boot option.
- **Fast Boot**
Enables or disables boot with initialization of a minimal set of devices required to launch active boot option. Has no effect for BBS boot options.
- **New Boot Option Policy**
Controls the placement of newly detected UEFI boot options.

3.1.6 Save & Exit

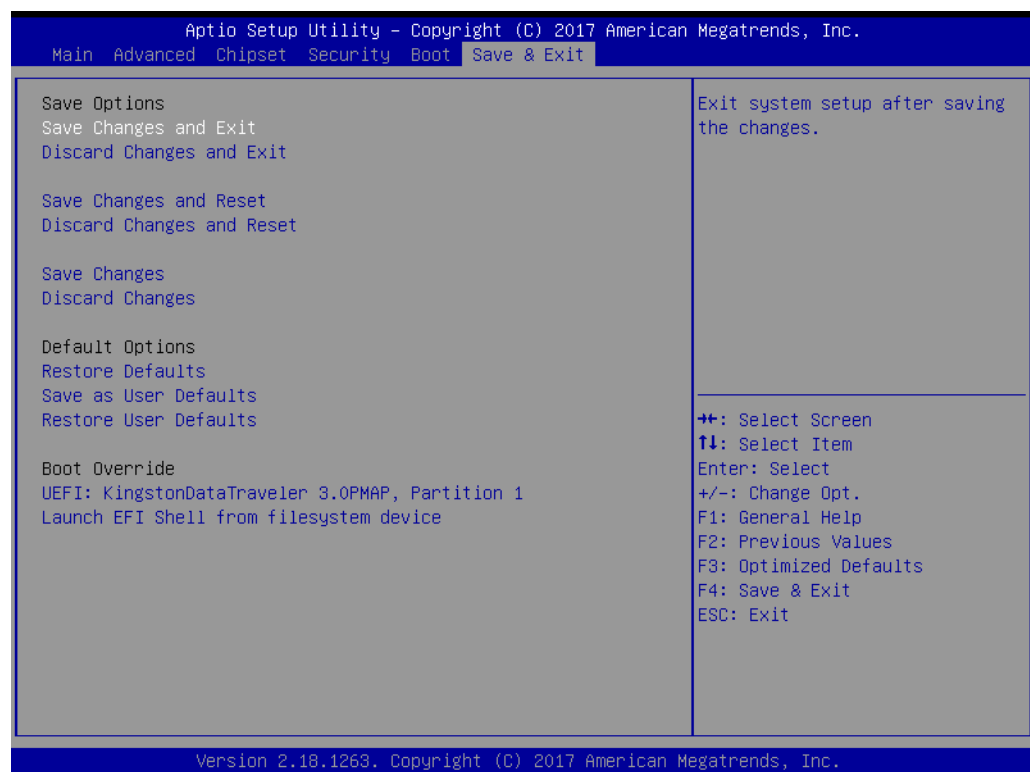

Figure 3.43 Save & Exit

■ Save Changes and Exit

When users have completed system configuration, select this option to save changes, exit BIOS setup menu and reboot the computer if necessary to take effect all system configuration parameters.

■ Discard Changes and Exit

Select this option to quit Setup without making any permanent changes to the system configuration.

■ Save Changes and Reset

When users have completed system configuration, select this option to save changes, exit BIOS setup menu and reboot the computer to take effect on all system configuration parameters.

■ Discard Changes and Reset

Select this option to quit Setup without making any permanent changes to the system configuration and reboot the computer.

■ Save Changes

When users have completed system configuration, select this option to save changes without exit BIOS setup menu.

■ Discard Changes

Select this option to discard any current changes and load previous system configuration.

■ Restore Defaults

The SOM-6898 automatically configures all setup items to optimal settings when users select this option. Optimal Defaults are designed for maximum system performance, but may not work best for all computer applications. In particular, do not use

the Optimal Defaults if the user's computer is experiencing system configuration problems.

- **Save User Defaults**

When users have completed system configuration, select this option to save changes as user defaults without exit BIOS setup menu.

- **Restore User Defaults**

Restore the User Defaults to all the setup options

- **Launch EFI Shell from file system device**

This items attempts to Launch EFI Shell application (Shell.efi) from one of the available file system devices.

Chapter 4

S/W Introduction & Installation

Sections include:

- S/W Introduction
- Driver Installation
- Advantech iManager

4.1 S/W Introduction

The mission of Advantech Embedded Software Services is to "Enhance quality of life with Advantech platforms and Microsoft Windows embedded technology." We enable Windows Embedded software products on Advantech platforms to more effectively support the embedded computing community. Customers are freed from the hassle of dealing with multiple vendors (Hardware suppliers, System integrators, Embedded OS distributor) for projects. Our goal is to make Windows Embedded Software solutions easily and widely available to the embedded computing community.

4.2 Driver Installation

The Intel Chipset Software Installation (CSI) utility installs the Windows INF files that outline to the operating system how the chipset components will be configured.

4.2.1 Windows Driver Setup

To install the drivers on a windows-based OS, please connect to the internet and go to <http://support.advantech.com.tw> to download the drivers that you want to install and follow Driver Setup instructions to complete the installation.











4.2.2 Other OS

To install the drivers for Linux or other OS, please connect to the internet and go to <http://support.advantech.com.tw> to download the setup file.

4.3 Advantech iManager

Advantech's platforms come equipped with iManager, a micro controller that provides embedded features for system integrators. Embedded features have been moved from the OS/BIOS level to the board level, to increase reliability and simplify integration.

iManager runs whether the operating system is running or not; it can count the boot times and running hours of the device, monitor device health, and provide an advanced watchdog to handle errors as they happen. iManager also comes with a secure & encrypted EEPROM for storing important security keys or other customer information. All the embedded functions are configured through the API and provide corresponding utilities to demonstrate. These APIs comply with PICMG EAPI (Embedded Application Programmable Interface) specifications and makes these embedded features easier to integrate, speed development schedules, and provide customer's with software continuity while upgrading hardware. More details of how to use the APIs and utilities, please refer to the Advantech iManager 2.0 Software API User Manual.

| | |
|--|---|
| Control | Monitor |
|  <p>GPIO</p> <p>General Purpose Input/Output is a flexible parallel interface that allows a variety of custom connections. It allows users to monitor the level of signal input or set the output status to switch on/off a device. Our API also provides Programmable GPIO, which allows developers to dynamically set the GPIO input or output status.</p> |  <p>Watchdog</p> <p>A watchdog timer (WDT) is a device that performs a specific operation after a certain period of time if something goes wrong and the system does not recover on its own. A watchdog timer can be programmed to perform a warm boot (restarting the system) after a certain number of seconds.</p> |
|  <p>SMBus</p> <p>SMBus is the System Management Bus defined by Intel® Corporation in 1995. It is used in personal computers and servers for low-speed system management communications. The SMBus API allows a developer to interface a embedded system environment and transfer serial messages using the SMBus protocols, allowing multiple simultaneous device control.</p> |  <p>Hardware Monitor</p> <p>The Hardware Monitor (HWM) API is a system health supervision API that inspects certain condition indexes, such as fan speed, temperature and voltage.</p> |
|  <p>I2C</p> <p>I2C is a bi-directional two wire bus that was developed by Philips for use in their televisions in the 1980s. The I2C API allows a developer to interface with an embedded system environment and transfer serial messages using the I2C protocols, allowing multiple simultaneous device control.</p> |  <p>Hardware Control</p> <p>The Hardware Control API allows developers to set the PWM (Pulse Width Modulation) value to adjust fan speed or other devices; it can also be used to adjust the LCD brightness.</p> |
| Display | Power Saving |
|  <p>Brightness Control</p> <p>The Brightness Control API allows a developer to interface with an embedded device to easily control brightness.</p> |  <p>CPU Speed</p> <p>Make use of Intel SpeedStep technology to reduce power power consumption. The system will automatically adjust the CPU Speed depending on system loading.</p> |
|  <p>Backlight</p> <p>The Backlight API allows a developer to control the backlight (screen) on/off in an embedded device.</p> |  <p>System Throttling</p> <p>Refers to a series of methods for reducing power consumption in computers by lowering the clock frequency. These APIs allow the user to lower the clock from 87.5% to 12.5%.</p> |

Appendix **A**

Pin Assignment

This appendix gives you the information about the hardware pin assignment of the SOM-6898 CPU System on Module.

Sections include:

- SOM-6898 Type 6 Pin Assignment

A.1 SOM-6898 Type 6 Pin Assignment

This section gives SOM-6898 pin assignment on COM Express connector which compliant with COMR.0 R2.1 Type 6 pin-out definitions. More details about how to use these pins and get design reference, please contact to Advantech for design guides, checklists, reference schematics, and other hardware/software support.

| SOM-6898 Row A,B | | | |
|-------------------------|----------------|-----|--------------|
| A1 | GND (FIXED) | B1 | GND (FIXED) |
| A2 | GBE0_MDI3- | B2 | GBE0_ACT# |
| A3 | GBE0_MDI3+ | B3 | LPC_FRAME# |
| A4 | GBE0_LINK100# | B4 | LPC_AD0 |
| A5 | GBE0_LINK1000# | B5 | LPC_AD1 |
| A6 | GBE0_MDI2- | B6 | LPC_AD2 |
| A7 | GBE0_MDI2+ | B7 | LPC_AD3 |
| A8 | GBE0_LINK# | B8 | N/A |
| A9 | GBE0_MDI1- | B9 | N/A |
| A10 | GBE0_MDI1+ | B10 | LPC_CLK |
| A11 | GND (FIXED) | B11 | GND (FIXED) |
| A12 | GBE0_MDI0- | B12 | PWRBTN# |
| A13 | GBE0_MDI0+ | B13 | SMB_CK |
| A14 | N/A | B14 | SMB_DAT |
| A15 | SUS_S3# | B15 | SMB_ALERT# |
| A16 | SATA0_TX+ | B16 | SATA1_TX+ |
| A17 | SATA0_TX- | B17 | SATA1_TX- |
| A18 | SUS_S4# | B18 | SUS_STAT# |
| A19 | SATA0_RX+ | B19 | SATA1_RX+ |
| A20 | SATA0_RX- | B20 | SATA1_RX- |
| A21 | GND (FIXED) | B21 | GND (FIXED) |
| A22 | SATA2_TX+ | B22 | SATA3_TX+ |
| A23 | SATA2_TX- | B23 | SATA3_TX- |
| A24 | SUS_S5# | B24 | PWR_OK |
| A25 | SATA2_RX+ | B25 | SATA3_RX+ |
| A26 | SATA2_RX- | B26 | SATA3_RX- |
| A27 | BATLOW# | B27 | WDT |
| A28 | (S)ATA_ACT# | B28 | AC/HDA_SDIN2 |
| A29 | AC/HDA_SYNC | B29 | AC/HDA_SDIN1 |
| A30 | AC/HDA_RST# | B30 | AC/HDA_SDIN0 |
| A31 | GND (FIXED) | B31 | GND (FIXED) |
| A32 | AC/HDA_BITCLK | B32 | SPKR |
| A33 | AC/HDA_SDOUT | B33 | I2C_CK |
| A34 | BIOS_DIS0# | B34 | I2C_DAT |
| A35 | THRMTRIP# | B35 | THRM# |
| A36 | USB6- | B36 | USB7- |
| A37 | USB6+ | B37 | USB7+ |
| A38 | USB_6_7_OC# | B38 | USB_4_5_OC# |
| A39 | USB4- | B39 | USB5- |
| A40 | USB4+ | B40 | USB5+ |
| A41 | GND (FIXED) | B41 | GND (FIXED) |

| | | | |
|-----|--------------------------------|-----|-----------------------------|
| A42 | USB2- | B42 | USB3- |
| A43 | USB2+ | B43 | USB3+ |
| A44 | USB_2_3_OC# | B44 | USB_0_1_OC# |
| A45 | USB0- | B45 | USB1- |
| A46 | USB0+ | B46 | USB1+ |
| A47 | VCC_RTC | B47 | EXCD1_PERST# |
| A48 | EXCD0_PERST# | B48 | EXCD1_CPPE# |
| A49 | EXCD0_CPPE# | B49 | SYS_RESET# |
| A50 | LPC_SERIRQ | B50 | CB_RESET# |
| A51 | GND (FIXED) | B51 | GND (FIXED) |
| A52 | PCIE_TX5+ | B52 | PCIE_RX5+ |
| A53 | PCIE_TX5- | B53 | PCIE_RX5- |
| A54 | GPIO | B54 | GPO1 |
| A55 | PCIE_TX4+ | B55 | PCIE_RX4+ |
| A56 | PCIE_TX4- | B56 | PCIE_RX4- |
| A57 | GND | B57 | GPO2 |
| A58 | PCIE_TX3+ (if C25 stuffed) | B58 | PCIE_RX3+ (if R545 stuffed) |
| A59 | PCIE_TX3- (if C24 stuffed) | B59 | PCIE_RX3- (if R546 stuffed) |
| A60 | GND (FIXED) | B60 | GND (FIXED) |
| A61 | PCIE_TX2+ | B61 | PCIE_RX2+ |
| A62 | PCIE_TX2- | B62 | PCIE_RX2- |
| A63 | GPI1 | B63 | GPO3 |
| A64 | PCIE_TX1+ | B64 | PCIE_RX1+ |
| A65 | PCIE_TX1- | B65 | PCIE_RX1- |
| A66 | GND | B66 | WAKE0# |
| A67 | GPI2 | B67 | WAKE1# |
| A68 | PCIE_TX0+ | B68 | PCIE_RX0+ |
| A69 | PCIE_TX0- | B69 | PCIE_RX0- |
| A70 | GND (FIXED) | B70 | GND (FIXED) |
| A71 | LVDS_A0+ | B71 | LVDS_B0+ |
| A72 | LVDS_A0- | B72 | LVDS_B0- |
| A73 | LVDS_A1+ | B73 | LVDS_B1+ |
| A74 | LVDS_A1- | B74 | LVDS_B1- |
| A75 | LVDS_A2+ | B75 | LVDS_B2+ |
| A76 | LVDS_A2- | B76 | LVDS_B2- |
| A77 | LVDS_VDD_EN | B77 | LVDS_B3+ |
| A78 | LVDS_A3+ | B78 | LVDS_B3- |
| A79 | LVDS_A3- | B79 | LVDS_BKLT_EN |
| A80 | GND (FIXED) | B80 | GND (FIXED) |
| A81 | LVDS_A_CK+ | B81 | LVDS_B_CK+ |
| A82 | LVDS_A_CK- | B82 | LVDS_B_CK- |
| A83 | LVDS_I2C_CK | B83 | LVDS_BKLT_CTRL |
| A84 | LVDS_I2C_DAT | B84 | VCC_5V_SBY |
| A85 | GPI3 | B85 | VCC_5V_SBY |
| A86 | RSVD(KBD_RST# if R472 stuffed) | B86 | VCC_5V_SBY |
| A87 | N/A | B87 | VCC_5V_SBY |
| A88 | PCIE_CLK_REF+ | B88 | BIOS_DIS1# |
| A89 | PCIE_CLK_REF- | B89 | VGA_RED |

| | | | |
|-------------------------|-------------|------|--------------------|
| A90 | GND (FIXED) | B90 | GND (FIXED) |
| A91 | SPI_POWER | B91 | VGA_GRN |
| A92 | SPI_MISO | B92 | VGA_BLU |
| A93 | GPO0 | B93 | VGA_HSYNC |
| A94 | SPI_CLK | B94 | VGA_VSYNC |
| A95 | SPI_MOSI | B95 | VGA_I2C_CK |
| A96 | N/A | B96 | VGA_I2C_DAT |
| A97 | TYPE10# | B97 | SPI_CS# |
| A98 | SER0_TX | B98 | RSVD |
| A99 | SER0_RX | B99 | RSVD |
| A100 | GND (FIXED) | B100 | GND (FIXED) |
| A101 | SER1_TX | B101 | FAN_PWMOUT |
| A102 | SER1_RX | B102 | FAN_TACHIN |
| A103 | LID# | B103 | SLEEP# |
| A104 | VCC_12V | B104 | VCC_12V |
| A105 | VCC_12V | B105 | VCC_12V |
| A106 | VCC_12V | B106 | VCC_12V |
| A107 | VCC_12V | B107 | VCC_12V |
| A108 | VCC_12V | B108 | VCC_12V |
| A109 | VCC_12V | B109 | VCC_12V |
| A110 | GND (FIXED) | B110 | GND (FIXED) |
| SOM-6898 Row C,D | | | |
| C1 | GND (FIXED) | D1 | GND (FIXED) |
| C2 | GND | D2 | GND |
| C3 | USB_SSRX0- | D3 | USB_SSTX0- |
| C4 | USB_SSRX0+ | D4 | USB_SSTX0+ |
| C5 | GND | D5 | GND |
| C6 | USB_SSRX1- | D6 | USB_SSTX1- |
| C7 | USB_SSRX1+ | D7 | USB_SSTX1+ |
| C8 | GND | D8 | GND |
| C9 | N/A | D9 | N/A |
| C10 | N/A | D10 | N/A |
| C11 | GND (FIXED) | D11 | GND (FIXED) |
| C12 | N/A | D12 | N/A |
| C13 | N/A | D13 | N/A |
| C14 | GND | D14 | GND |
| C15 | N/A | D15 | DDI1_CTRLCLK_AUX+ |
| C16 | N/A | D16 | DDI1_CTRLDATA_AUX- |
| C17 | RSVD | D17 | RSVD |
| C18 | RSVD | D18 | RSVD |
| C19 | N/A | D19 | N/A |
| C20 | N/A | D20 | N/A |
| C21 | GND (FIXED) | D21 | GND (FIXED) |
| C22 | N/A | D22 | N/A |
| C23 | N/A | D23 | N/A |
| C24 | DDI1_HPD | D24 | RSVD |
| C25 | N/A | D25 | RSVD |

| | | | |
|-----|--|-----|---|
| C26 | N/A | D26 | DDI1_PAIR0+ |
| C27 | RSVD | D27 | DDI1_PAIR0- |
| C28 | RSVD | D28 | RSVD |
| C29 | N/A | D29 | DDI1_PAIR1+ |
| C30 | N/A | D30 | DDI1_PAIR1- |
| C31 | GND (FIXED) | D31 | GND (FIXED) |
| C32 | DDI2_CTRLCLK_AUX+ (if R108 stuffed) | D32 | DDI1_PAIR2+ |
| C33 | DDI2_CTRLCLK_AUX- (if R109 stuffed) | D33 | DDI1_PAIR2- |
| C34 | DDI2_DDC_AUX_SEL (if R108/R109 stuffed) | D34 | DDI1_DDC_AUX_SEL |
| C35 | RSVD | D35 | RSVD |
| C36 | N/A | D36 | DDI1_PAIR3+ |
| C37 | N/A | D37 | DDI1_PAIR3- |
| C38 | N/A | D38 | RSVD |
| C39 | N/A | D39 | DDI2_PAIR0+ (if R6 stuffed) |
| C40 | N/A | D40 | DDI2_PAIR0- (if R5 stuffed) |
| C41 | GND (FIXED) | D41 | GND (FIXED) |
| C42 | N/A | D42 | DDI2_PAIR1+ (if R8 stuffed) |
| C43 | N/A | D43 | DDI2_PAIR1- (if R7 stuffed) |
| C44 | N/A | D44 | DDI2_HPDP (if R544 stuffed) |
| C45 | RSVD | D45 | RSVD |
| C46 | N/A | D46 | DDI2_PAIR2+ (if R5/R6/R7/R8 stuffed) |
| C47 | N/A | D47 | DDI2_PAIR2- (if R5/R6/R7/R8 stuffed) |
| C48 | RSVD | D48 | RSVD |
| C49 | N/A | D49 | DDI2_PAIR3+ (if R5/R6/R7/R8 stuffed) |
| C50 | N/A | D50 | DDI2_PAIR3- (if R5/R6/R7/R8 stuffed) |
| C51 | GND (FIXED) | D51 | GND (FIXED) |
| C52 | PCIE_RX16+ (if R140 stuffed) | D52 | PCIE_TX16+ (if C13 stuffed) |
| C53 | PCIE_RX16- (if R139 stuffed) | D53 | PCIE_TX16- (if C12 stuffed) |
| C54 | TYPE0# | D54 | N/A |
| C55 | PCIE_RX17+ (if R140/R139 stuffed) | D55 | PCIE_TX17+ (if C13/C12 stuffed) |
| C56 | PCIE_RX17- (if R140/R139 stuffed) | D56 | PCIE_TX17- (if C13/C12 stuffed) |
| C57 | TYPE1# | D57 | TYPE2# |
| C58 | PCIE_RX18+ (if R140/R139 stuffed) | D58 | PCIE_TX18+ (if C13/C12 stuffed) |
| C59 | PCIE_RX18- (if R140/R139 stuffed) | D59 | PCIE_TX18- (if C13/C12 stuffed) |
| C60 | GND (FIXED) | D60 | GND (FIXED) |
| C61 | PCIE_RX19+ (if R140/R139 stuffed) | D61 | PCIE_TX19+ (if C13/C12 stuffed) |
| C62 | PCIE_RX19- (if R140/R139 stuffed) | D62 | PCIE_TX19- (if C13/C12 stuffed) |
| C63 | RSVD | D63 | RSVD |

| | | | |
|------|-------------|------|-------------|
| C64 | RSVD | D64 | RSVD |
| C65 | N/A | D65 | N/A |
| C66 | N/A | D66 | N/A |
| C67 | RSVD | D67 | GND |
| C68 | N/A | D68 | N/A |
| C69 | N/A | D69 | N/A |
| C70 | GND (FIXED) | D70 | GND (FIXED) |
| C71 | N/A | D71 | N/A |
| C72 | N/A | D72 | N/A |
| C73 | GND | D73 | GND |
| C74 | N/A | D74 | N/A |
| C75 | N/A | D75 | N/A |
| C76 | GND | D76 | GND |
| C77 | RSVD | D77 | RSVD |
| C78 | N/A | D78 | N/A |
| C79 | N/A | D79 | N/A |
| C80 | GND (FIXED) | D80 | GND (FIXED) |
| C81 | N/A | D81 | N/A |
| C82 | N/A | D82 | N/A |
| C83 | RSVD | D83 | RSVD |
| C84 | GND | D84 | GND |
| C85 | N/A | D85 | N/A |
| C86 | N/A | D86 | N/A |
| C87 | GND | D87 | GND |
| C88 | N/A | D88 | N/A |
| C89 | N/A | D89 | N/A |
| C90 | GND (FIXED) | D90 | GND (FIXED) |
| C91 | N/A | D91 | N/A |
| C92 | N/A | D92 | N/A |
| C93 | GND | D93 | GND |
| C94 | N/A | D94 | N/A |
| C95 | N/A | D95 | N/A |
| C96 | GND | D96 | GND |
| C97 | RSVD | D97 | N/A |
| C98 | N/A | D98 | N/A |
| C99 | N/A | D99 | N/A |
| C100 | GND (FIXED) | D100 | GND (FIXED) |
| C101 | N/A | D101 | N/A |
| C102 | N/A | D102 | N/A |
| C103 | GND | D103 | GND |
| C104 | VCC_12V | D104 | VCC_12V |
| C105 | VCC_12V | D105 | VCC_12V |
| C106 | VCC_12V | D106 | VCC_12V |
| C107 | VCC_12V | D107 | VCC_12V |
| C108 | VCC_12V | D108 | VCC_12V |
| C109 | VCC_12V | D109 | VCC_12V |
| C110 | GND (FIXED) | D110 | GND (FIXED) |

Appendix **B**

Watchdog Timer

This appendix gives you the information about the watchdog timer programming on the SOM-6898 CPU System on Module.

Sections include:

- Watchdog Timer Programming

B.1 Programming the Watchdog Timer

| Trigger Event | Note |
|------------------|----------------------------------|
| IRQ | (BIOS setting default disable)** |
| NMI | N/A |
| SCI | Power button event |
| Power Off | Support |
| H/W Restart | Support |
| WDT Pin Activate | Support |

** WDT new driver support automatically selects available IRQ number from BIOS, and then sets EC. Only Win 10 supports it.

In other OS, it will still use IRQ number from BIOS setting as usual.

For details, please refer to *iManager & Software API User Manual*:

Appendix **C**

Programming GPIO

This Appendix gives the illustration of the General Purpose Input and Output pin setting.

Sections include:

- System I/O Ports

C.1 GPIO Register

| GPIO Byte Mapping | H/W Pin Name |
|-------------------|--------------|
| BIT0 | GPO0 |
| BIT1 | GPO1 |
| BIT2 | GPO2 |
| BIT3 | GPO3 |
| BIT4 | GPI0 |
| BIT5 | GPI1 |
| BIT6 | GPI2 |
| BIT7 | GPI3 |

For details, please refer to *iManager & Software API User Manual*.

Appendix **D**

System Assignments

This appendix gives you the information about the system resource allocation on the SOM-6898 CPU System on Module.

Sections include:

- System I/O ports
- Interrupt Assignments
- 1st MB Memory Map

D.1 System I/O Ports

Table D.1: System I/O ports

| Addr.Range(Hex) | Device |
|------------------------|--|
| 0000-0CF7 | PCI Express Root Complex |
| 0020-0021 | Programmable interrupt controller |
| 0024-0025 | Programmable interrupt controller |
| 0028-0029 | Programmable interrupt controller |
| 002C-002D | Programmable interrupt controller |
| 002E-002F | Motherboard resources |
| 0030-0031 | Programmable interrupt controller |
| 0034-0035 | Programmable interrupt controller |
| 0038-0039 | Programmable interrupt controller |
| 003C-003D | Programmable interrupt controller |
| 0040-0043 | System timer |
| 004E-004F | Motherboard resources |
| 0050-0053 | System timer |
| 0060-0060 | Standard PS/2 Keyboard |
| 0061-0061 | Motherboard resources |
| 0062-0062 | Microsoft ACPI-Compliant Embedded Controller |
| 0063-0063 | Motherboard resources |
| 0064-0064 | Standard PS/2 Keyboard |
| 0065-0065 | Motherboard resources |
| 0066-0066 | Microsoft ACPI-Compliant Embedded Controller |
| 0067-0067 | Motherboard resources |
| 0070-0070 | Motherboard resources |
| 0070-0077 | System CMOS/real time clock |
| 0080-0080 | Motherboard resources |
| 0092-0092 | Motherboard resources |
| 00A0-00A1 | Programmable interrupt controller |
| 00A4-00A5 | Programmable interrupt controller |
| 00A8-00A9 | Programmable interrupt controller |
| 00AC-00AD | Programmable interrupt controller |
| 00B0-00B1 | Programmable interrupt controller |
| 00B2-00B3 | Motherboard resources |
| 00B4-00B5 | Programmable interrupt controller |
| 00B8-00B9 | Programmable interrupt controller |
| 00BC-00BD | Programmable interrupt controller |
| 029C-029D | Motherboard resources |
| 02E8-02EF | Communications Port (COM4) |
| 02F8-02FF | Communications Port (COM2) |
| 0378-037F | Printer Port (LPT1) |
| 03E8-03EF | Communications Port (COM3) |
| 03F8-03FF | Communications Port (COM1) |
| 04D0-04D1 | Programmable interrupt controller |
| 0680-069F | Motherboard resources |
| 0D00-0FFF | PCI Express Root Complex |

Table D.1: System I/O ports

| | |
|-----------|--|
| 164E-164F | Motherboard resources |
| 1800-18FE | Motherboard resources |
| 1854-1857 | Motherboard resources |
| F000-F03F | Intel(R) HD Graphics 620 |
| F040-F05F | Mobile 6th Generation Intel(R) Processor Family I/O SMBUS-9D23 |
| F060-F07F | Standard SATA AHCI Controller |
| F080-F083 | Standard SATA AHCI Controller |
| F090-F097 | Standard SATA AHCI Controller |
| FF00-FFFE | Motherboard resources |
| FFFF-FFFF | Motherboard resources |

D.2 Interrupt Assignments

Table D.2: Interrupt Assignments

| Interrupt# | Interrupt Source |
|-------------------|--|
| IRQ 0 | System Timer |
| IRQ 1 | Standard PS/2 Keyboard |
| IRQ 3 | Communications Port (COM2) |
| IRQ 4 | Communications Port (COM1) |
| IRQ 5 | Communications Port (COM4) |
| IRQ 6 | Communications Port (COM3) |
| IRQ 7 | Printer Port(LPT1) |
| IRQ 8 | System CMOS/real time clock |
| IRQ 11 | Mobile 6th/7th Generation Intel® Processor Family I/O Thermal subsystem - 9D31 |
| IRQ 11 | Mobile 6th/7th Generation Intel® Processor Family I/O SMBUS - 9D23 |
| IRQ 12 | Microsoft PS/2 Mouse |
| IRQ 14 | Motherboard resources |
| IRQ 54~511 | Microsoft ACPI-Compliant System |
| IRQ 16 | High Definition Audio Controller |
| IRQ 20 | Intel(R) Serial IO UART Host Controller – 9D27 |
| IRQ 21 | Mobile 6th/7th Generation Intel® Processor Family I/O SCC: eMMC – 9D2B |
| IRQ FFFFFFFFA(-6) | Intel® Management Engine Interface |
| IRQ FFFFFFFFB(-5) | Intel® USB 3.0 eXtensible Host Controller – 1.0(Microsoft) |
| IRQ FFFFFFFFC(-4) | Intel® HD Graphics 620 |
| IRQ FFFFFFFFD(-3) | Intel® Ethernet Connection I219-V |
| IRQ FFFFFFFFE(-2) | Standard SATA AHCI Controller |

D.3 1st MB Memory Map

Table D.3: 1st MB Memory Map

| Addr. Range (Hex) | Device |
|-------------------------|--|
| 0x000A0000-0x000BFFFF | PCI Express Root Complex |
| 0x90000000-0xDFFFFFFF | PCI Express Root Complex |
| 0xC0000000-0xCFFFFFFF | Intel(R) HD Graphics 620 |
| 0xDE000000-0xDEFFFFFF | Intel(R) HD Graphics 620 |
| 0xDF000000-0xDF01FFFF | Intel(R) I210 Ethernet Connection I219-V |
| 0xDF020000-0xDF02FFFF | High Definition Audio Controller |
| 0xDF030000-0xDF03FFFF | Intel(R) USB 3.0 eXtensible Host controller |
| 0xDF040000-0xDF043FFF | High Definition Audio Controller |
| 0xDF044000-0xDF047FFF | Mobile 6th Generation Intel(R) Processor Family I/O PMC - 9D21 |
| 0xDF048000-0xDF049FFF | Standard SATA AHCI Controller |
| 0xDF04A000-0xDF04A0FF | Mobile 6th/7th Generation Intel(R) Processor Family I/O SMBUS - 9D23 |
| 0xDF04B000-0xDF04BFFF | Mobile 6th/7th Generation Intel(R) Processor Family I/O SCC:eMMC – 9D2B |
| 0xDF04B000-0xDF04BFFF | Mobile 6th/7th Generation Intel(R) Processor Family I/O SCC:SDCard – 9D2D |
| 0xDF04D000-0xDF04D7FF | Standard SATA AHCI Controller |
| 0xDF04E000-0xDF04E0FF | Standard SATA AHCI Controller |
| 0xDF050000-0xDF050FFF | Mobile 6th/7th Generation Intel(R) Processor Family I/O Thermal subsystem - 9D31 |
| 0xDFFE0000-0xDFFFFFFF | Motherboard resources |
| 0xE0000000-0xEFFFFFFF | Motherboard resources |
| 0xFD000000-0xFDABFFFF | Motherboard resources |
| 0xFD000000-0xFE7FFFFF | PCI Express Root Complex |
| 0xFDAC0000-0xFEACFFFF | Motherboard resources |
| 0xFDAD0000-0xFEADFFFF | Motherboard resources |
| 0xFDAE0000-0xFEAEFFFF | Motherboard resources |
| 0xFDAF0000-0xFEAFFFFF | Motherboard resources |
| 0xFDB00000-0xFDFFFFFFFF | Motherboard resources |
| 0xFE000000-0xFE01FFFF | Motherboard resources |
| 0xFE028000-0xFE028FFF | Motherboard resources |
| 0xFE029000-0xFE029FFF | Motherboard resources |
| 0xFE036000-0xFE03BFFF | Motherboard resources |
| 0xFE03D000-0xFE3FFFFF | Motherboard resources |
| 0xFE40E000-0xFE40EFFF | Intel(R) Management Engine Interface |
| 0xFE40F000-0xFE40FFFF | Intel(R) Serial IO UART Host Controller – 9D27 |
| 0xFE410000-0xFE7FFFFF | Motherboard resources |
| 0xFED00000-0xFED003FF | High precision event timer |
| 0xFED10000-0xFED17FFF | Motherboard resources |
| 0xFED18000-0xFED18FFF | Motherboard resources |
| 0xFED19000-0xFED19FFF | Motherboard resources |
| 0xFED20000-0xFED3FFFF | Motherboard resources |
| 0xFED45000-0xFED8FFFF | Motherboard resources |

Table D.3: 1st MB Memory Map

| | |
|-------------------------|-----------------------|
| 0xFED90000-0xFED93FFF | Motherboard resources |
| 0xFEE00000-0xFEEFFFFFFF | Motherboard resources |
| 0xFF000000-0xFFFFFFFF | Legacy device |
| 0xFF000000-0xFFFFFFFF | Motherboard resources |

ADVANTECH

Enabling an Intelligent Planet

www.advantech.com

Please verify specifications before quoting. This guide is intended for reference purposes only.

All product specifications are subject to change without notice.

No part of this publication may be reproduced in any form or by any means, electronic, photocopying, recording or otherwise, without prior written permission of the publisher.

All brand and product names are trademarks or registered trademarks of their respective companies.

© Advantech Co., Ltd. 2017