

# RJ45 10/100 Base-T Jack with Magnetic Module and PoE



16.6 x 13.5 x 32.6 mm

**RoHS**  
Compliant

**ARJP11C**

## FEATURES:

- PoE
- Available with or without LED
- Suitable CAT 5 & 6 cable and UTP
- Comply IEEE 802.3ab
- LAN Magnetic with RJ45
- Suitable for RoHS compliant reflow

## APPLICATIONS:

- 10/100 base-T LAN
- NIC, LoM and PC

## STANDARD SPECIFICATIONS at 25°C

**Operating temperature range: 0°C to +70°C    Storage temperature range: -40°C to +85°C**

Part Number	Turns Ratio ± 5%		EMI Fingers	LEDs L/R	Insertion Loss (dB TYP) 1- 100 MHz	Return Loss (dB TYP @100Ω±15Ω)		
	Tx	Rx				1- 10 MHz	30 MHz	60 - 80 MHz
ARJP11C-MASA-A-B-EMU2	1CT:1CT	1CT:1CT	Yes	G/Y	-1	-20	-16	-12
ARJP11C-MASB-AB-A-FMU2	1CT:1CT	1CT:1CT	Yes	G_Y/G	-1	-20	-16	-12
ARJP11C-MBSC-LT2	1CT:1	1CT:1	Yes	NONE	-1	-20	-16	-12
ARJP11C-MASD-AB-A-FMU2	1CT:1CT	1CT:1CT	Yes	G_Y/G	-1	-20	-16	-12

Part Number	Crosstalk (dB TYP)			Common Mode Rejection (dB TYP)		Hipot (Vrms) @60Hz
	1 - 10 MHz	30 - 60 MHz	60 - 100 MHz	1 - 50 MHz	50 - 130 MHz	
ARJP11C-MASA-A-B-EMU2	-40	-35	-30	-26	-20	1500
ARJP11C-MASB-AB-A-FMU2	-40	-35	-30	-26	-20	1500
ARJP11C-MBSC-LT2	-40	-35	-30	-26	-20	1000
ARJP11C-MASD-AB-A-FMU2	-40	-35	-30	-26	-20	1000

Contact Abracon for more custom configurations. See options to build a custom configuration.

## OPTIONS AND PART IDENTIFICATION

ARJP11C- [ ] [ ] - [ ] - [ ] - [ ] [ ] [ ] [ ]

Mechanical	Schematic	Left LED color (e.g. B for Yellow, AB for Green-Yellow)	Right LED color (e.g. B for Yellow, AB for Green-Yellow)	LED polarity	Turns Ratio (Tx)	Turns Ratio (Rx)	Gold plating
MA, MB <small>(Please see mechanical section)</small>	SA ~ SD <small>(Please see schematic section)</small>	Blank: No LED A: Green B: Yellow C: Amber D: Orange	Blank: No LED A: Green B: Yellow C: Amber D: Orange	Blank: No LED E, F <small>(Please see 7.0 LED polarity section)</small>	K: 1CT:1.41 L: 1CT:1 M: 1CT:1CT N: 1.414:1CT O: 1CT:1.41CT P: 1:2CT Q: 1:1.414CT R: 1CT:2.5	S: 1CT:1.41 T: 1CT:1 U: 1CT:1CT V: 1.414:1CT W: 1CT:1.41CT X: 1:2CT Y: 1:1.414CT Z: 1CT:2.5	1: 3u <sup>“</sup> 2: 6u <sup>“</sup> 3: 15u <sup>“</sup> 4: 30u <sup>“</sup> 5: 50u <sup>“</sup>



# RJ45 10/100 Base-T Jack with Magnetic Module and PoE

ARJP11C

RoHS  
Compliant



16.6 x 13.5 x 32.6 mm

## MECHANICAL DIMENSIONS

MA

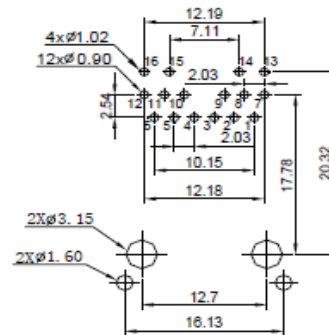
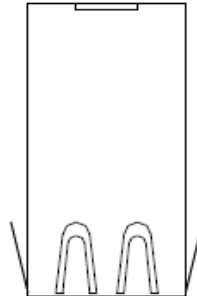

PC Board Layout  
Component Side Shown

LED LED

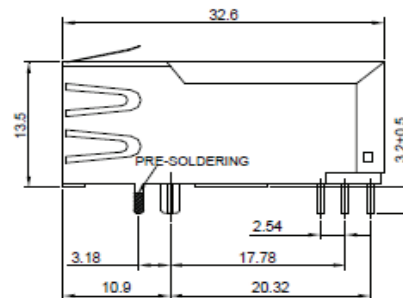
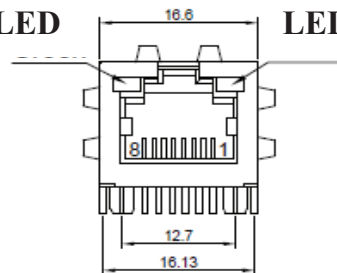

MB

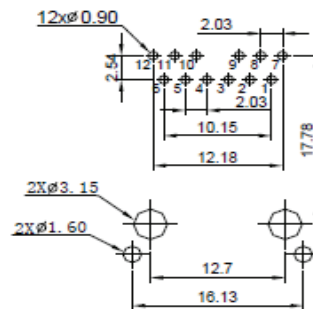
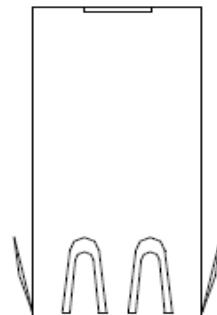

PC Board Layout  
Component Side Shown

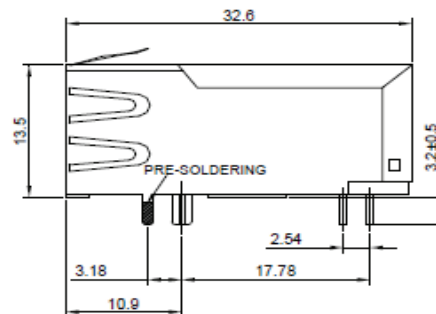
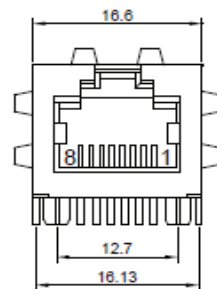

# RJ45 10/100 Base-T Jack with Magnetic Module and PoE



16.6 x 13.5 x 32.6 mm

**RoHS**  
Compliant

ARJP11C

## SCHEMATICS

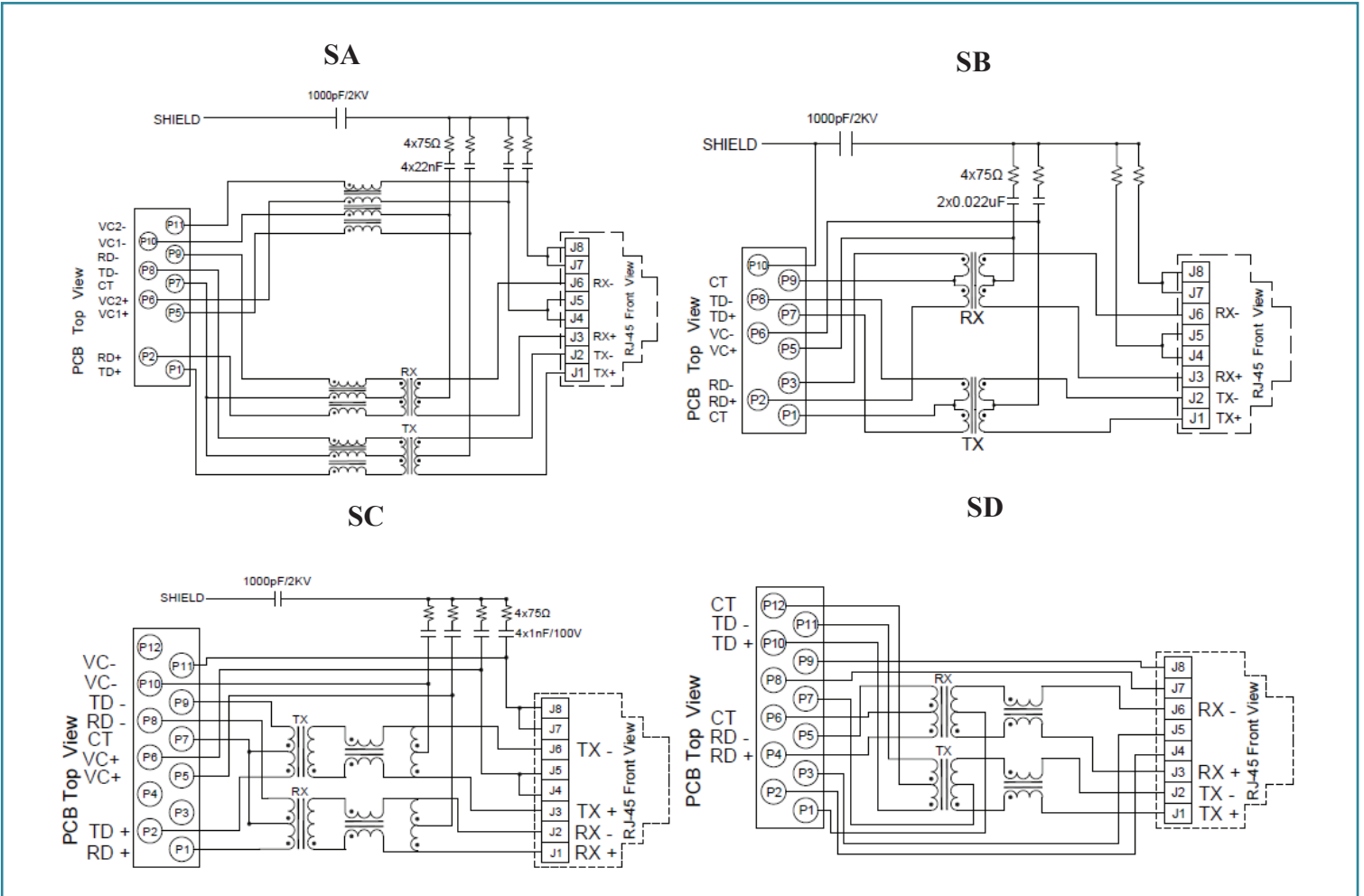

## LED POLARITY

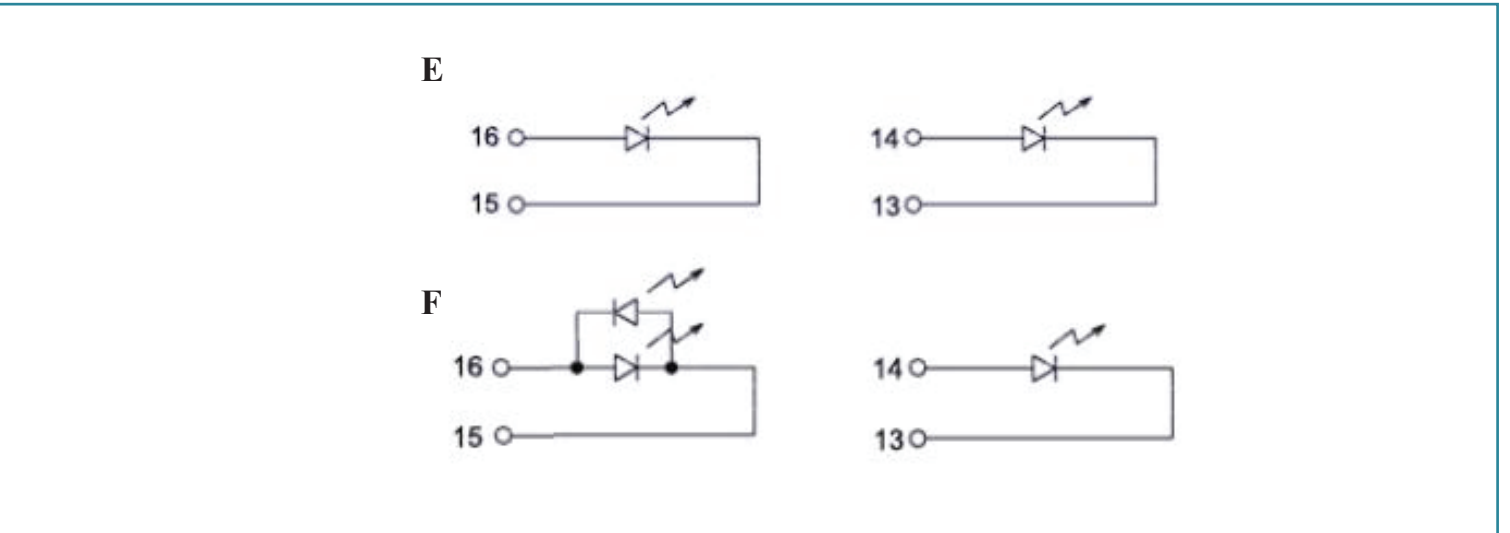

ABRACON IS  
ISO 9001:2008  
CERTIFIED

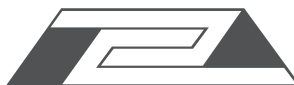

**ABRACON**  
CORPORATION

Visit [www.abracon.com](http://www.abracon.com) for Terms & Conditions of Sale  
30332 Esperanza, Rancho Santa Margarita, California 92688  
tel 949-546-8000 | fax 949-546-8001 | [www.abracon.com](http://www.abracon.com)

Revised: 05.10.11

# RJ45 10/100 Base-T Jack with Magnetic Module and PoE

ARJP11C

RoHS  
Compliant



16.6 x 13.5 x 32.6 mm

PACKING: 60pcs/tray

Packaging material: PET

Outer carton unit : 840 pcs/ 14 Trays/box

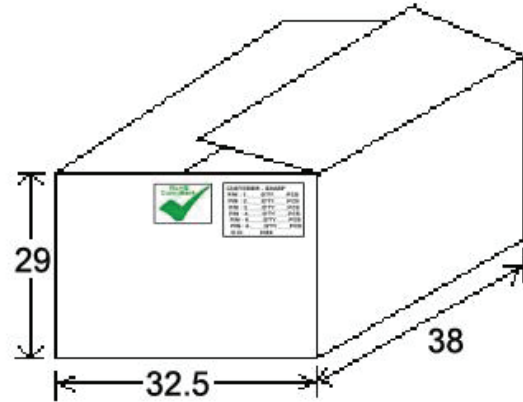
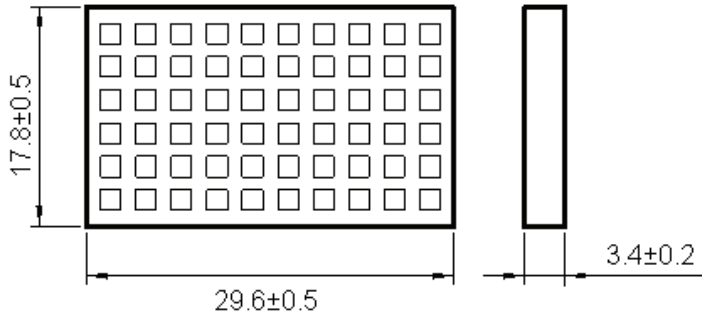

REFLOW PROFILE:

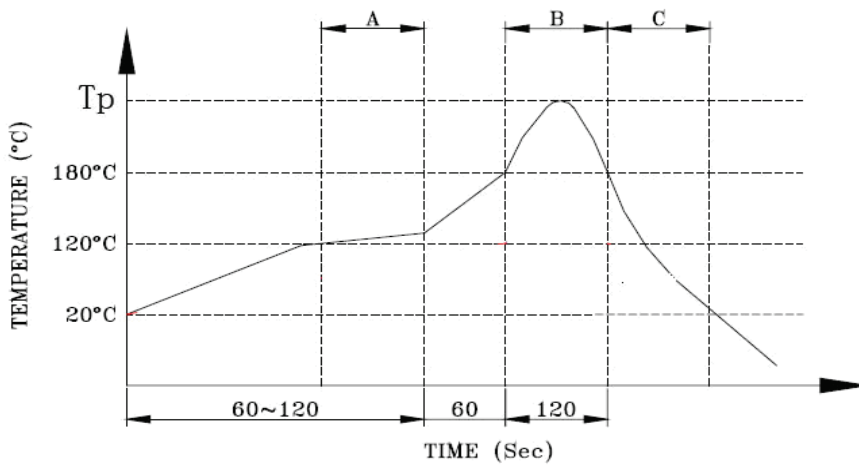

Peak temperature(Tp) : 250± 10°C  
Peak temperature(Tp) time : 5sec max

A. Preheating B. Soldering C. Gradual Cooling

**ATTENTION:** Abracon Corporation's products are COTS – Commercial-Off-The-Shelf products; suitable for Commercial, Industrial and, where designated, Automotive Applications. Abracon's products are not specifically designed for Military, Aviation, Aerospace, Life-dependant Medical applications or any application requiring high reliability where component failure could result in loss of life and/or property. For applications requiring high reliability and/or presenting an extreme operating environment, written consent and authorization from Abracon Corporation is required. Please contact Abracon Corporation for more information.

ABRACON IS  
ISO 9001:2008  
CERTIFIED

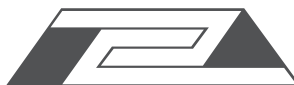

**ABRACON**  
CORPORATION

Visit [www.abracon.com](http://www.abracon.com) for Terms & Conditions of Sale  
30332 Esperanza, Rancho Santa Margarita, California 92688  
tel 949-546-8000 | fax 949-546-8001 | [www.abracon.com](http://www.abracon.com)

Revised: 05.10.11