

DETAILS

Product Number	CN13127_MIRELLA-50-S-PF
Family	Mirella
Type	RefPack
Color	metal
Diameter	49,9 mm
Height	24,8 mm
Style	round
Optic Material	
Holder Material	
Fastening	screw, socket
Status	production ready
ROHS Compliant	Yes
Date Updated	19/12/2016



OPTICAL PROPERTIES

LED	Viewing	Light	Efficiency	cd/lm	Connector
	Angle	Beam			
CLL01x	14 deg	Spot	88 %	7.700	-
CLL02x/CLU02x (LES10)	19 deg	Spot	87 %	4.200	-
CLU700/701	13 deg	Spot	89 %	7.300	-
MT-G	17 deg	Spot	90 %	5.300	-
MT-G2	18 deg	Spot	88 %	4.200	-
MK-R	12 deg	Spot	87 %	8.100	-
XHP70	15 deg	Spot	89 %	0.630	-
XHP50	11 deg	Spot	89 %	9.200	-
MHD-E/G	14 deg	Spot	93 %	6.100	-
COB 4W	14 deg	Spot	91 %	6.700	-
CXM-6	14 deg	Spot	86 %	6.700	-
CXM-7	17 deg	Spot	87 %	5.100	-
Duris S10	13 deg	Spot	87 %	6.600	LEDiL: LEDiL
Duris S8	sim: 9,5	Spot	sim: 94 %	sim: 12.500-	
Soleriq S9	sim: 21	Spot	sim: 91 %	sim: 3.500	LEDiL: LEDiL
ZC4/6	18 deg	Spot	88 %	4.800	-
Mini Zenigata (GW6BM)	17 deg	Spot	91 %	4.800	-
SLE G5 LES6	12 deg	Spot	89 %	8.980	LEDiL: LEDiL
SLE G5 LES11	21 deg	Spot	88 %	3.390	LEDiL: LEDiL

Relative intensity of Mirella-S-4WLG

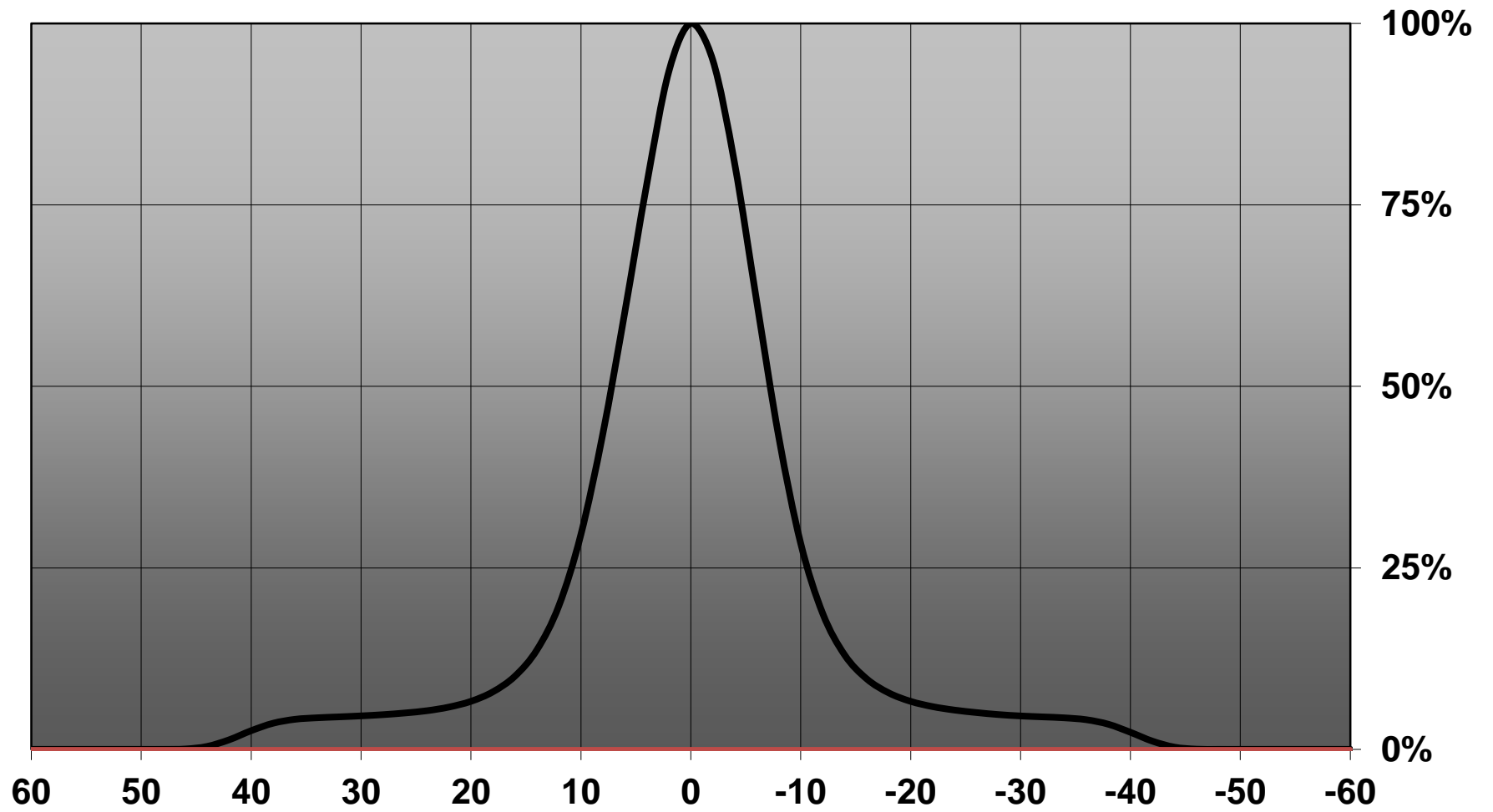

NOTE: It is recommended to use glue like DELO-PUR 9895 for pin fastening.
[http://www.dele.de/fileadmin/datasheet/DELO-PUR_9895_\(TIDB-GB\).pdf](http://www.dele.de/fileadmin/datasheet/DELO-PUR_9895_(TIDB-GB).pdf)

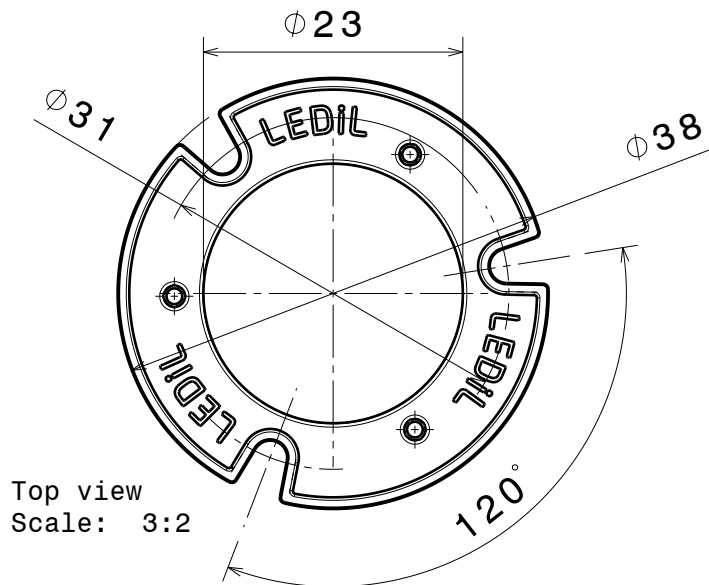

Top view
Scale: 3:2

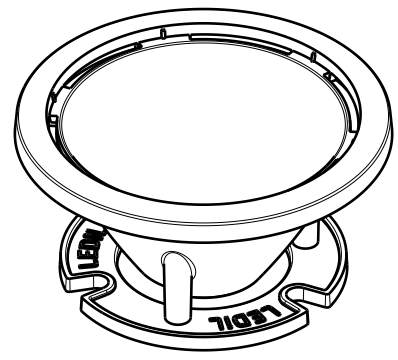

Isometric view

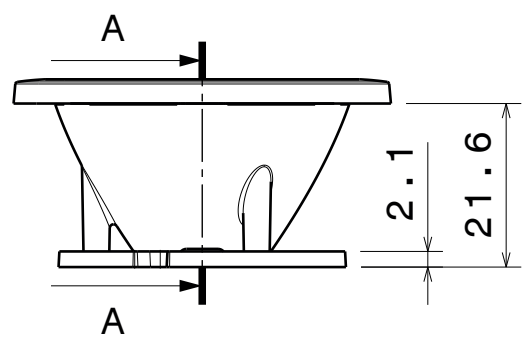

Front view

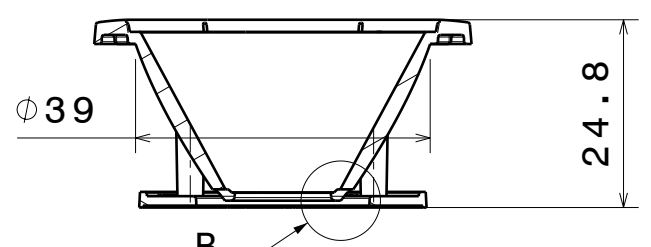

Section view A-A

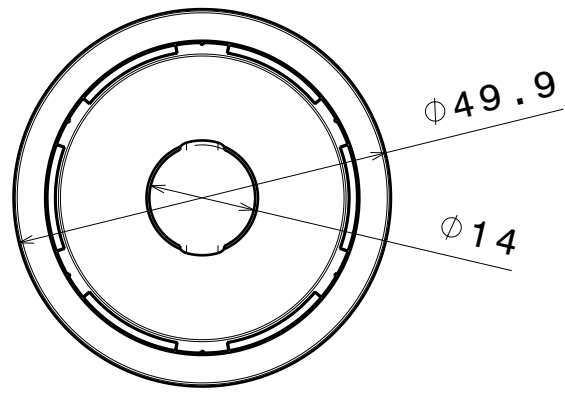

Top view

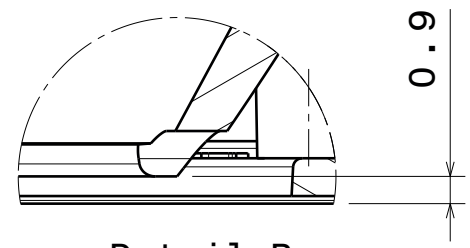

Detail B

INDEX	PART NO	DESCRIPTION	MATERIAL	COLOUR
1	C13085	MIRELLA-50-S-PF	PC	Metal
2	C13083	MIRELLA-SOCKET	PC	White

This drawing is our property. It can't be reproduced or communicated without our written agreement.

LEDIL Oy
 Salorankatu 10
 FIN 24240 SALO
 Finland

DRAWING TITLE Mechanical drawing

DRAWN BY jp
 DATE 15.1.2014

DATASHEET MIRELLA-50-S-PF

CHECKED BY -
 DATE -

SIZE A4
 CN13127
 REV 001

DESIGNED BY as
 DATE -

SCALE 1:1 WEIGHT - SHEET 1/1

Luminaire: Ledil oy CN13127_MIRELLA-50-S-PF (Citizen CII010 113lm @ 100mA) Efficiency=88%
Lamps: 1 x Citizen CII010 113lm @ 100mA

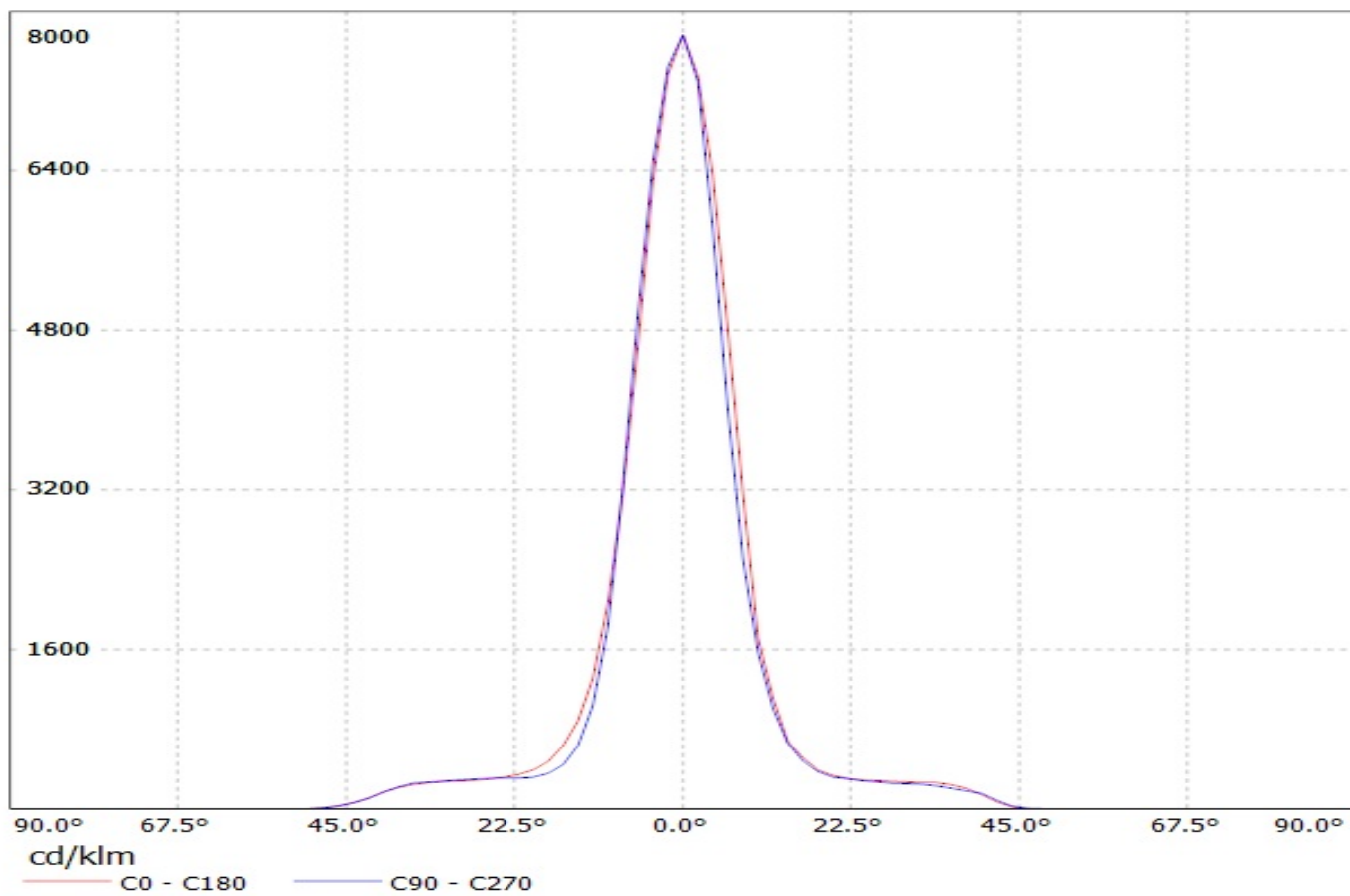

Luminaire: Ledil Oy CN13127_MIRELLA-50-S-PF (Citizen CII020 361lm @ 100mA) Efficiency=87%
Lamps: 1 x Citizen CII020 361lm @ 100mA

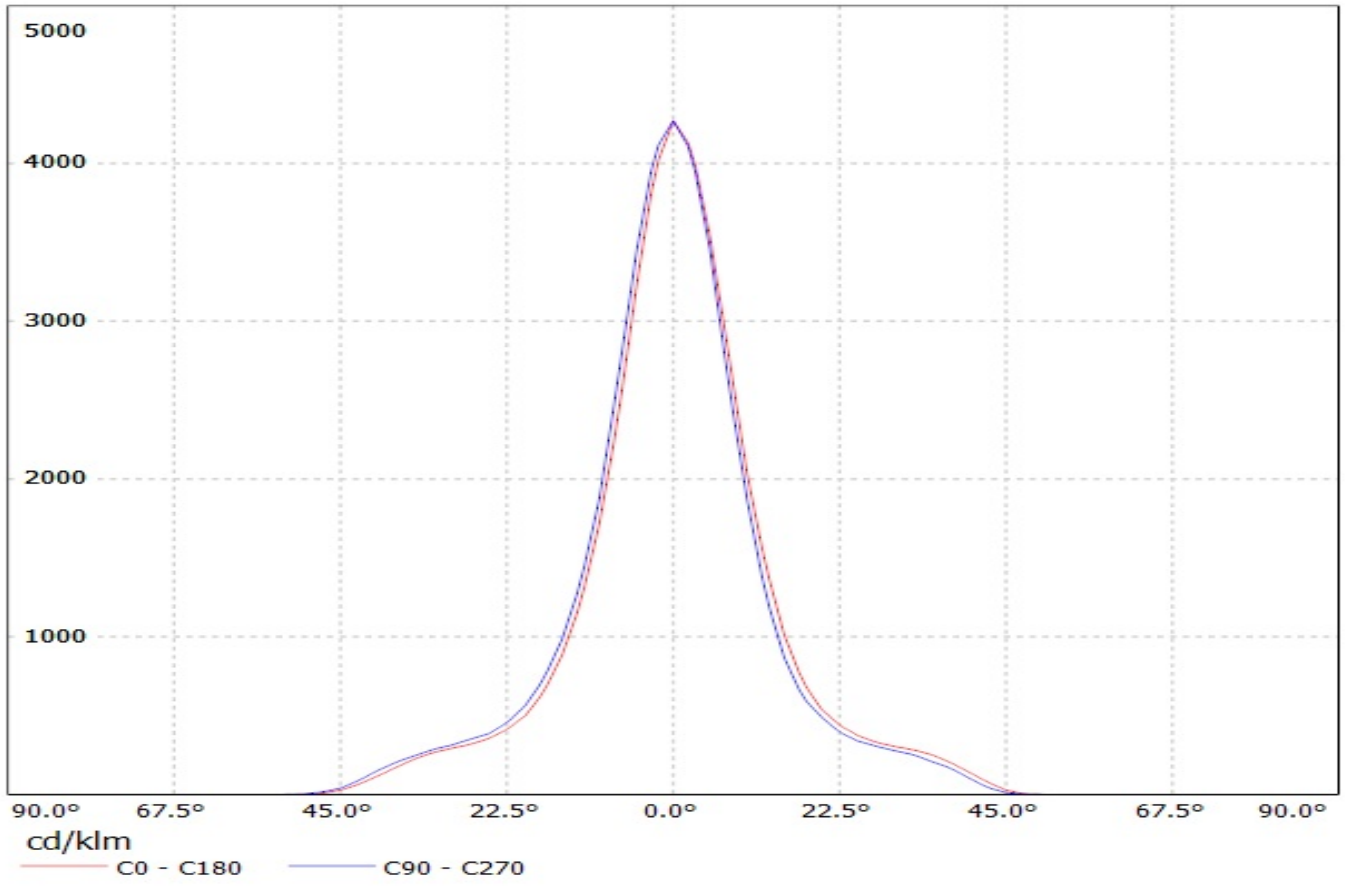

Luminaire: LEDiL Oy CN13127_MIRELLA-50-S-PF_(CLU700)

Lamps: 1 x Citizen_CLU700_C13083_PF-SOCKET_394.785lm@100mA_P=2.92999W_I=0.1044A

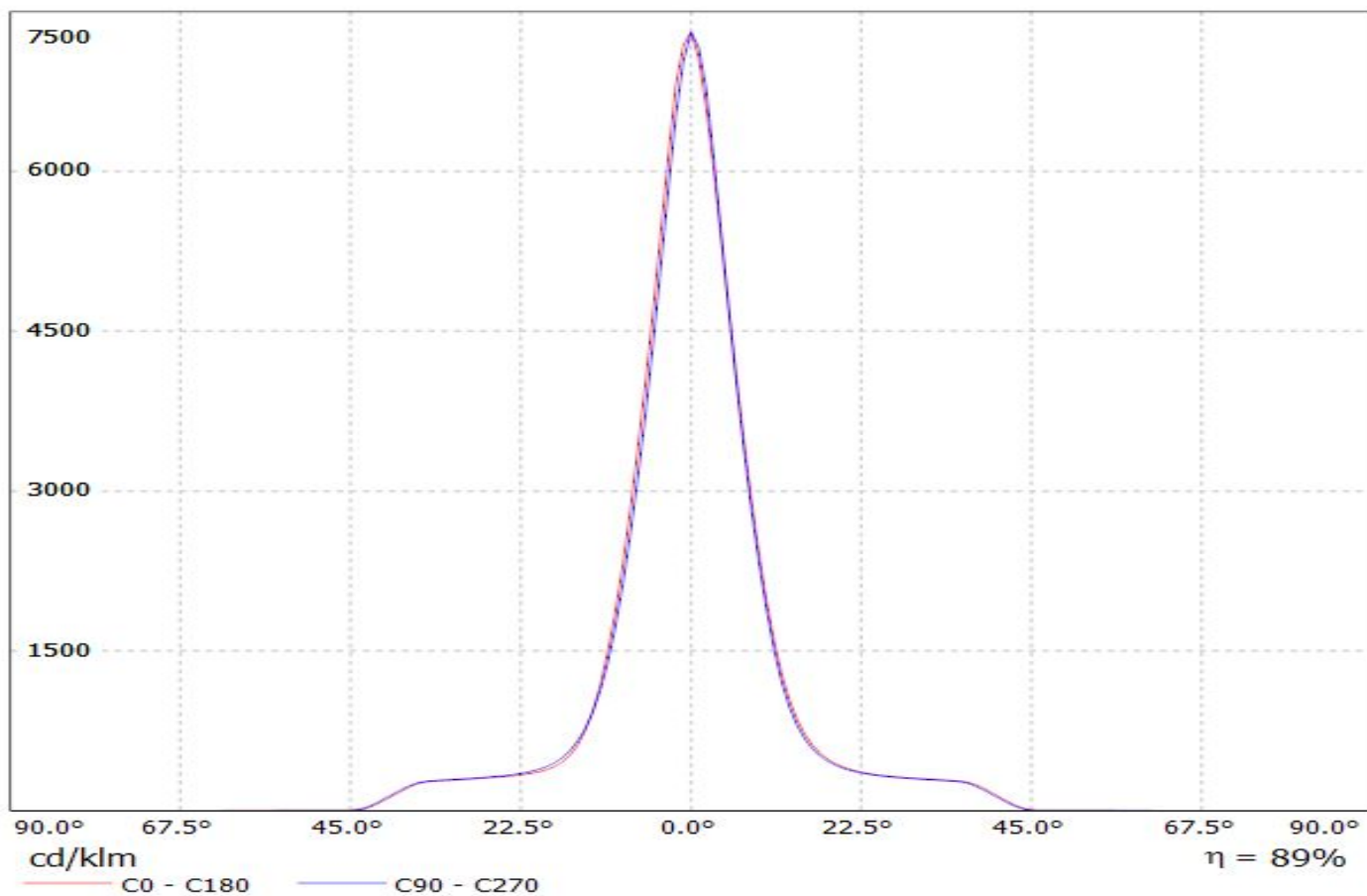

Luminaire: Ledil oy CN13127_MIRELLA-50-S-PF (Cree MT-G 714lm @ 250mA) Efficiency=90%
Lamps: 1 x Cree MT-G 714lm @ 250mA

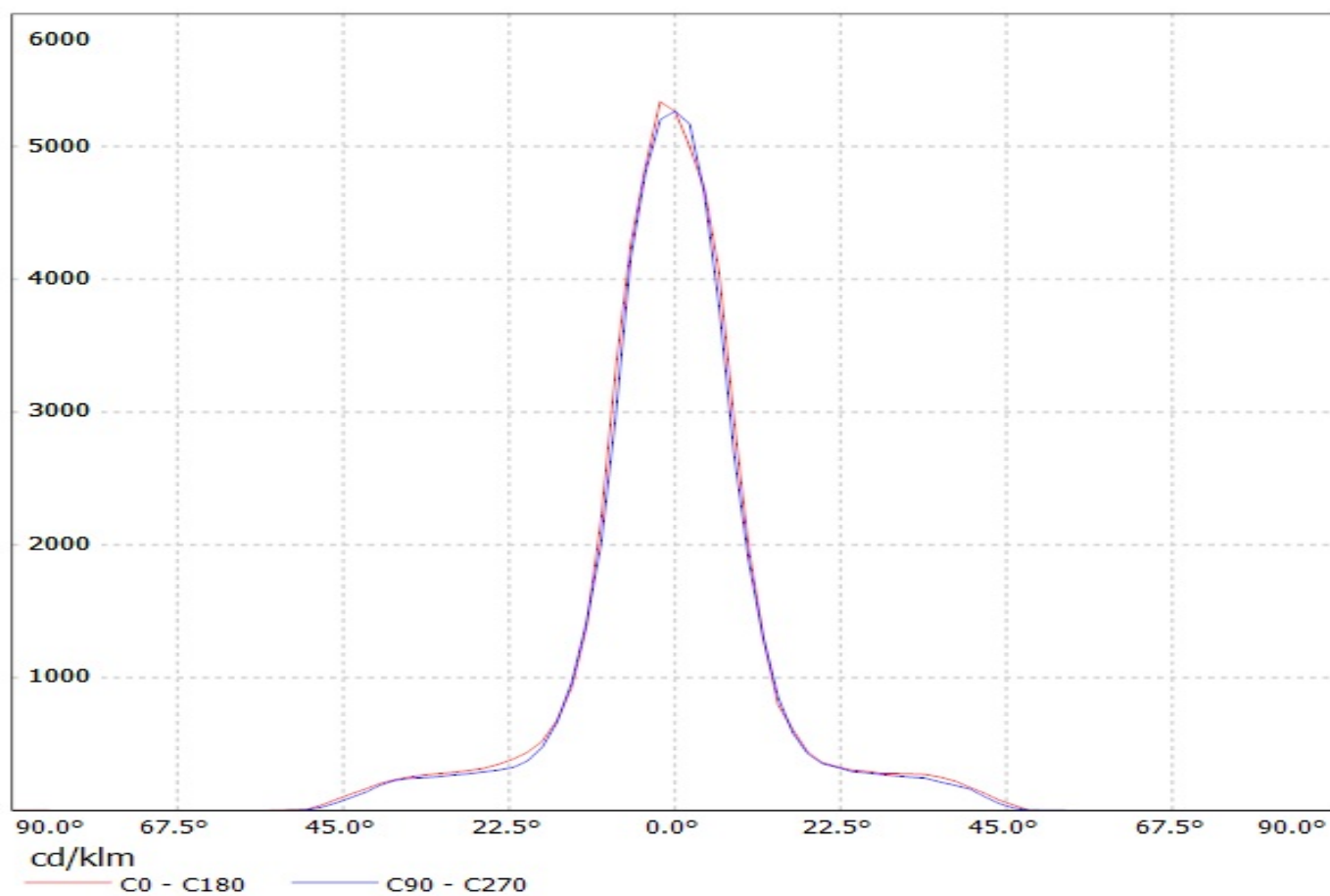

Luminaire: Ledil Oy CN13127_MIRELLA-50-S-PF (Cree MT-G2 172lm @ 250mA) Efficiency=88%
Lamps: 1 x Cree MT-G2 172lm @ 250mA

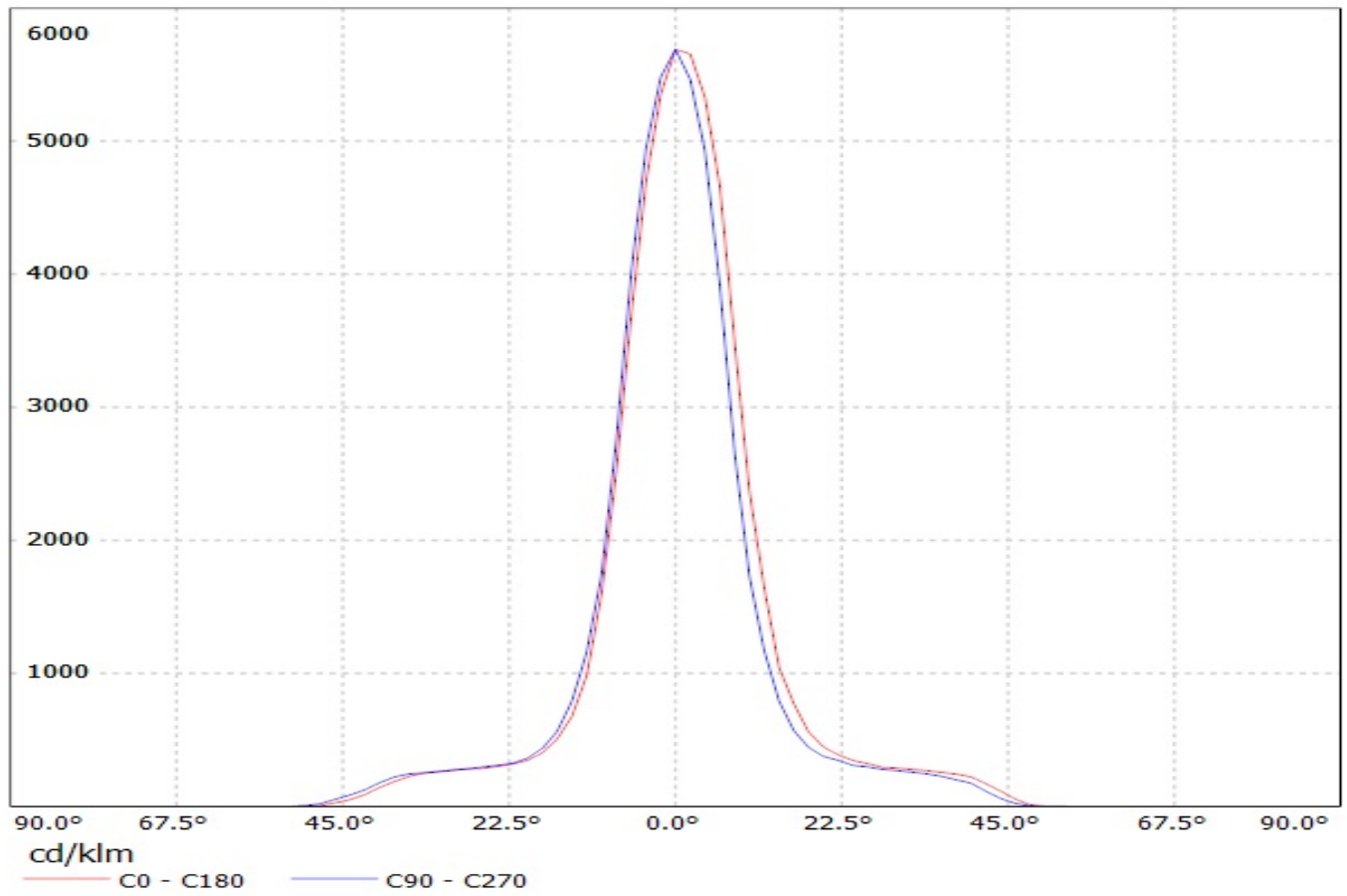

Luminaire: LEDiL Oy CN13127_MIRELLA-50-S-PF_(MK-R) Eff.87.4%
Lamps: 1 x CREE_MK-R_361lm@250mA_P=2.84311W_I=249.9mA

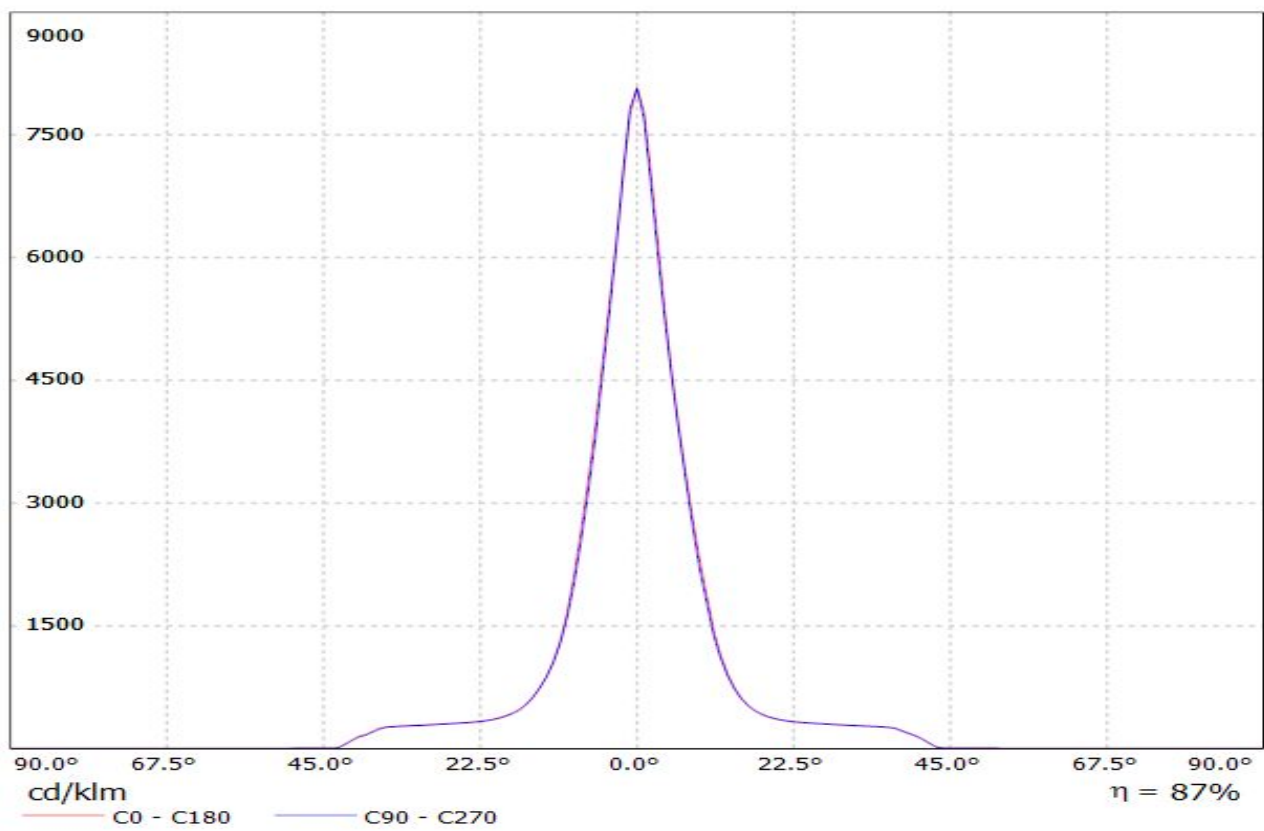

Luminaire: LEDiL Oy CN13127_MIRELLA-50-S-PF_(XHP70)
Lamps: 1 x Cree_XHP70_262.055lm@250mA_P=1.38275W_I=249.9mA

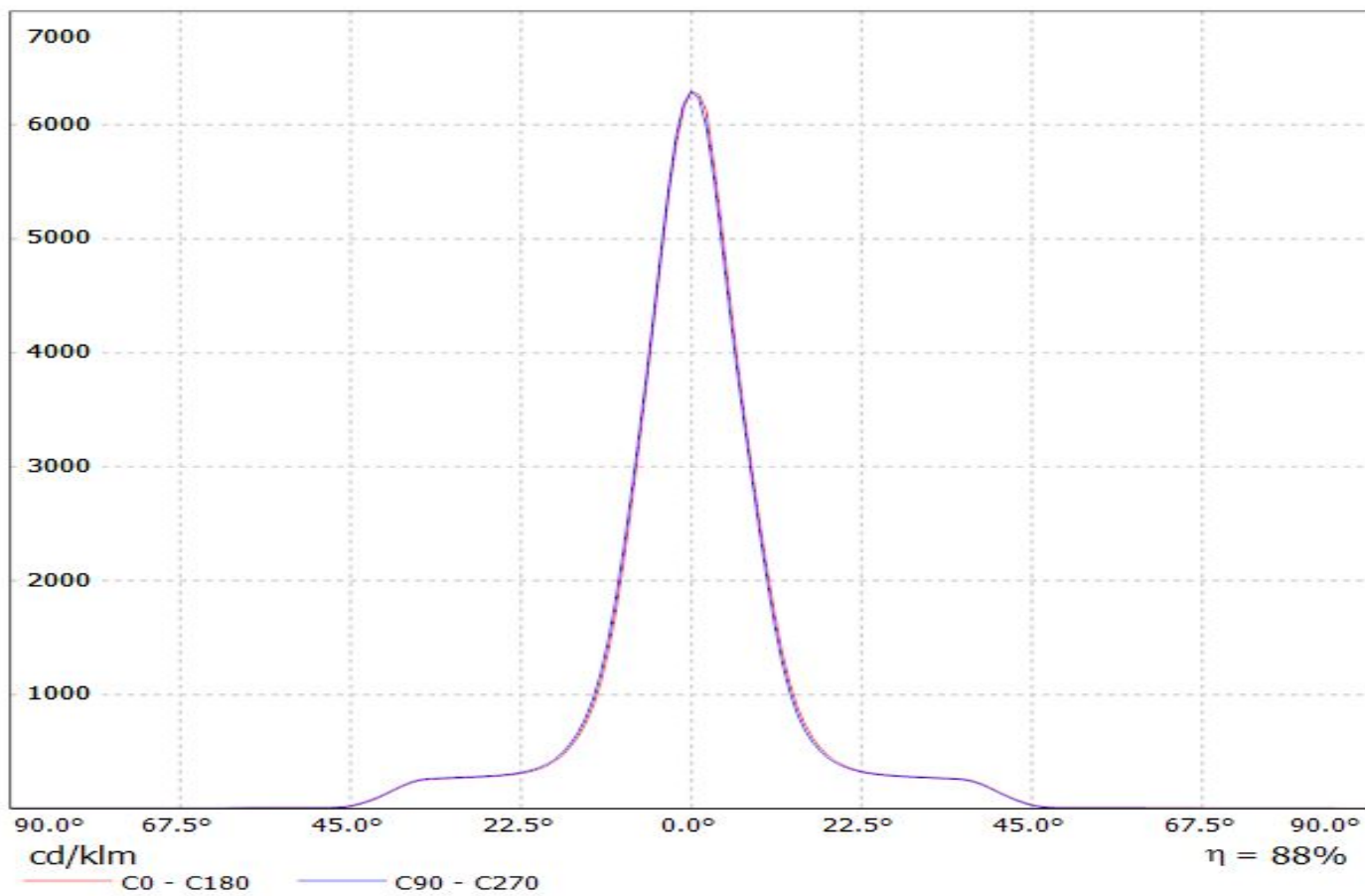

Luminaire: LEDiL Oy CN13127_MIRELLA-50-S-PF_(Cree_XHP50_WW)
Lamps: 1 x Cree_XHP50_WW_196.271lm@250mA_P=1.39897W_I=0.2499A

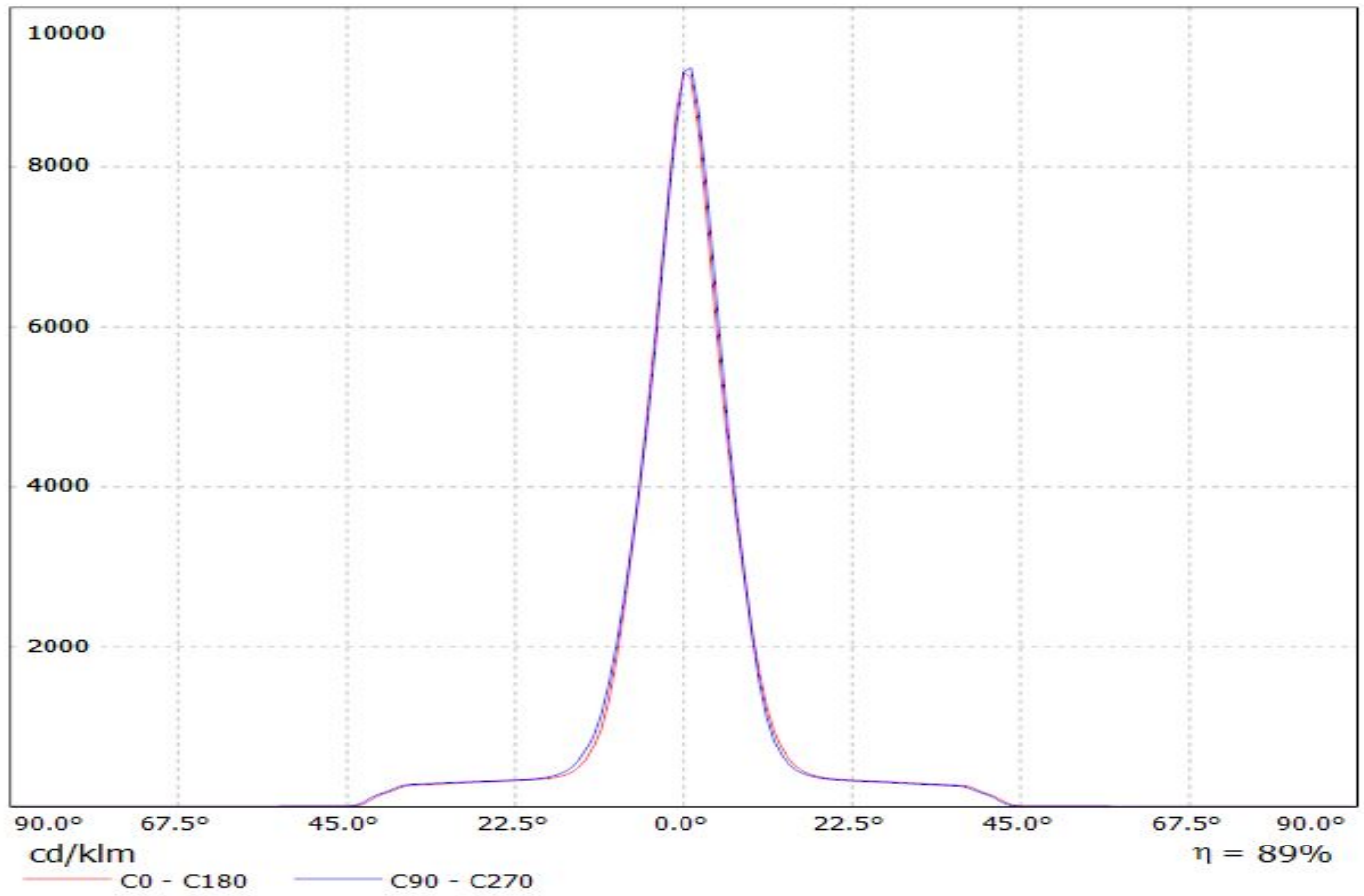

Luminaire: Ledil CN13127_MIRELLA-50-S-PF_(MHD-G)
Lamps: 1 x Cree MHD-G_530.44lm@100mA_P=3.0W_I=0.100A

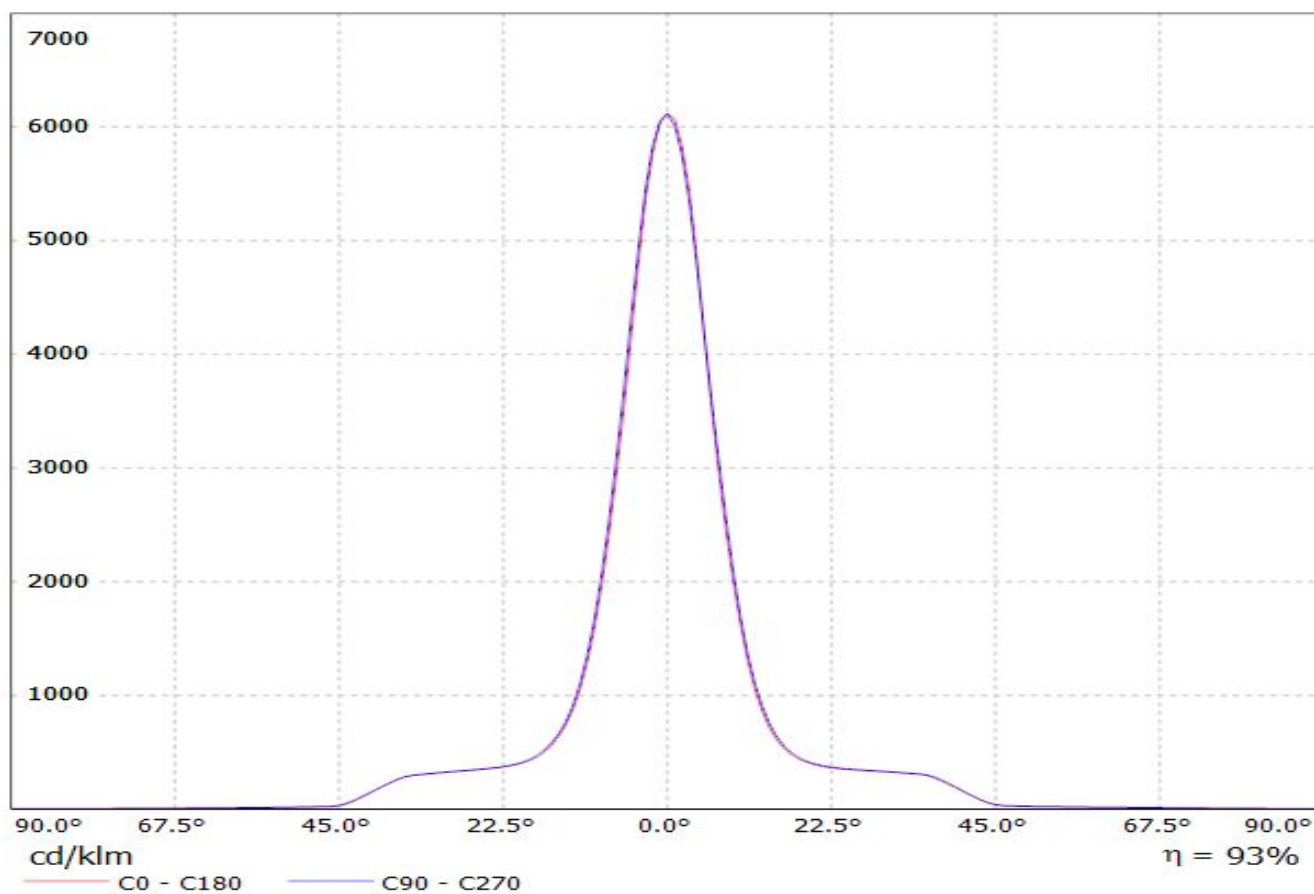

Luminaire: LEDil Oy CN13127_MIRELLA-50-S-PF_(CXM-6) Efficiency=86%
Lamps: 1 x Luminus XNOVA CXM-6 (437lm @ 120mA) CCT=3200K P=4.2W I=120mA

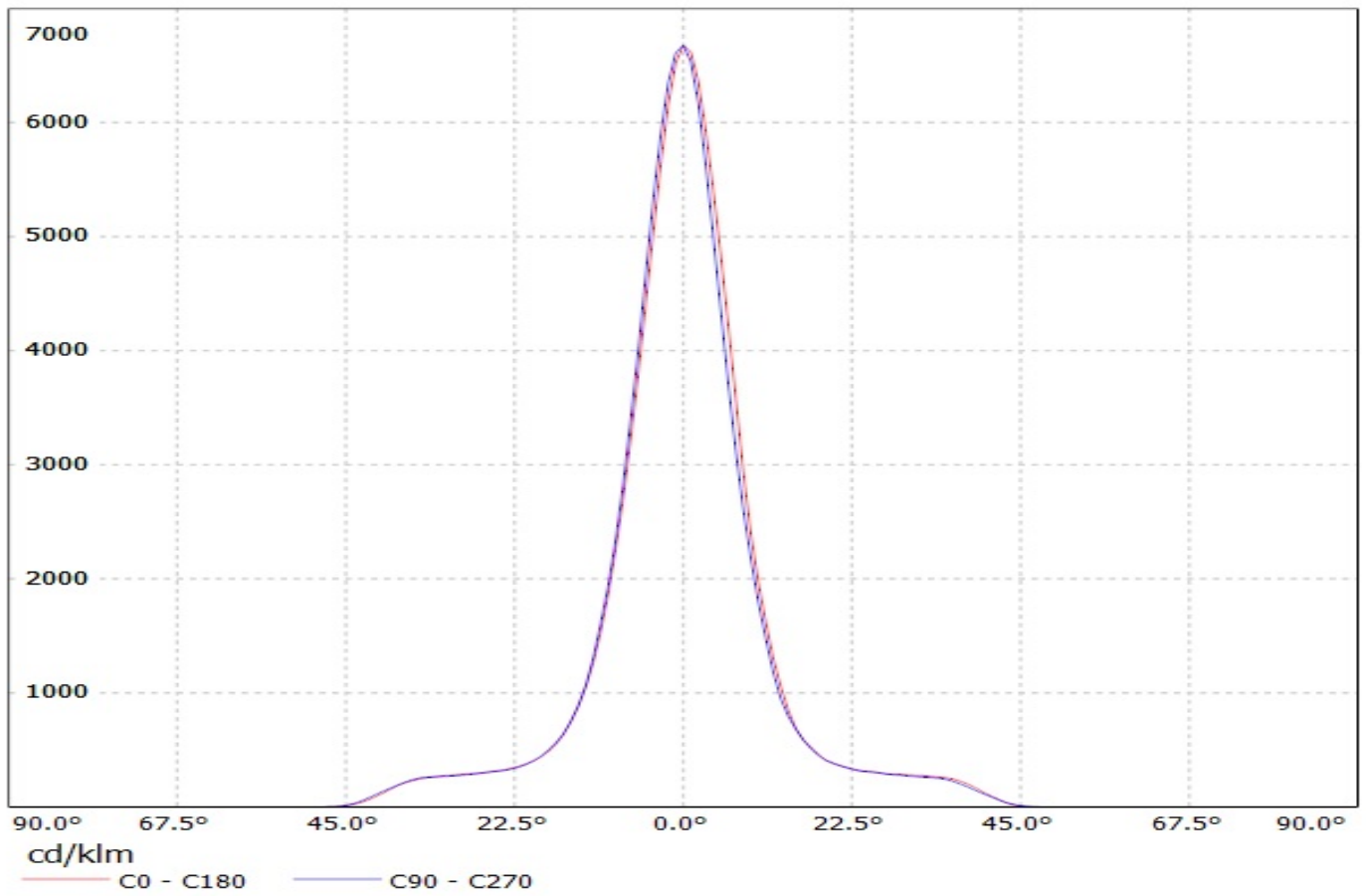

Luminaire: LEDil Oy CN13127_MIRELLA-50-S-PF_(CXM-7) Efficiency=87%
Lamps: 1 x Luminus XNOVA CXM-7 (522lm @ 160mA) CCT=2900K P=5.6W I=160mA

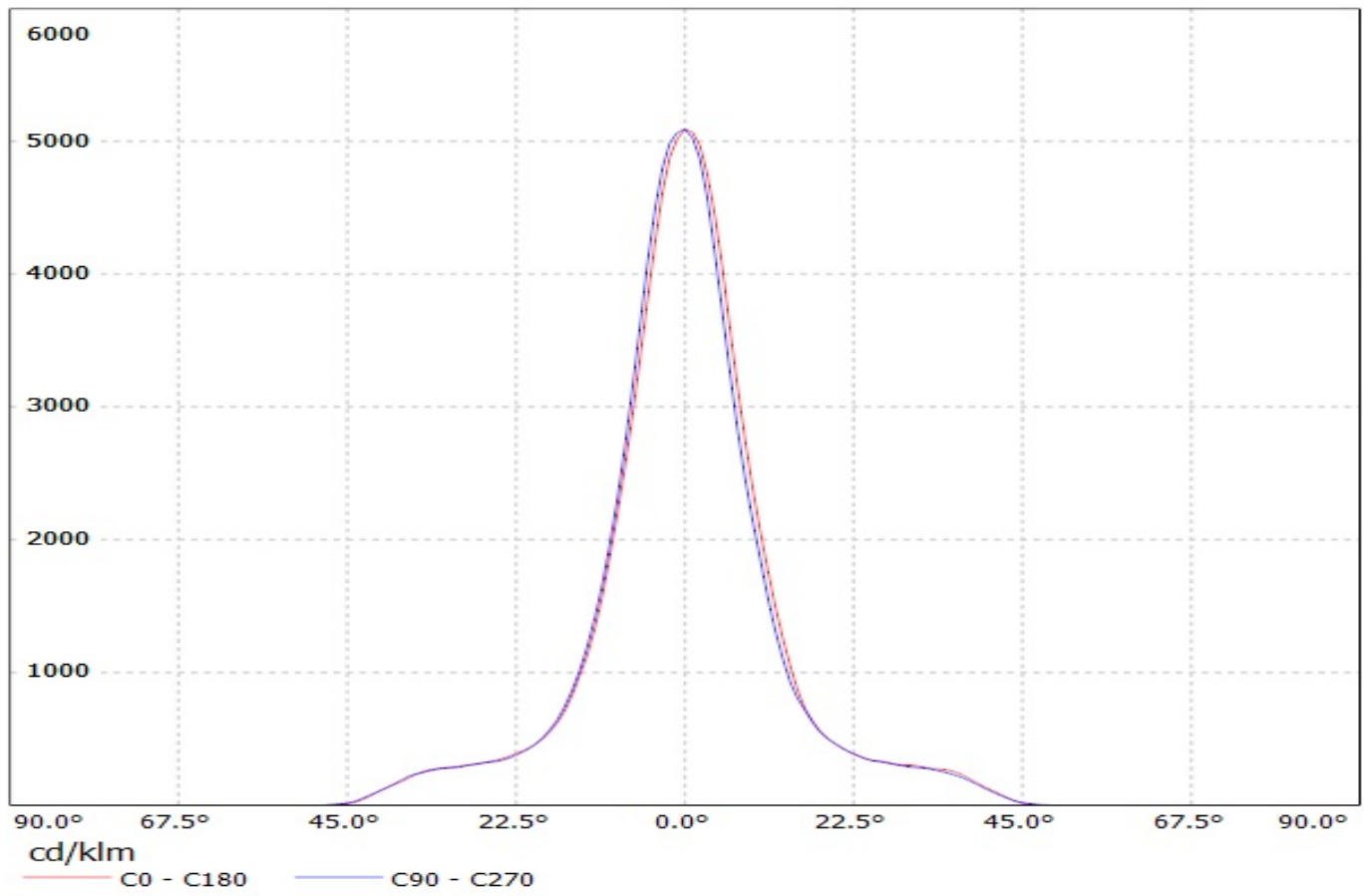

Luminaire: Ledil CN13127_MIRELLA-50-S-PF_(Duris_S10)

Lamps: 1 x Osram_Duris_S10_(GWP7LM32.CM)_298.59lm@100mA_P=2.52277W_I=0.1A

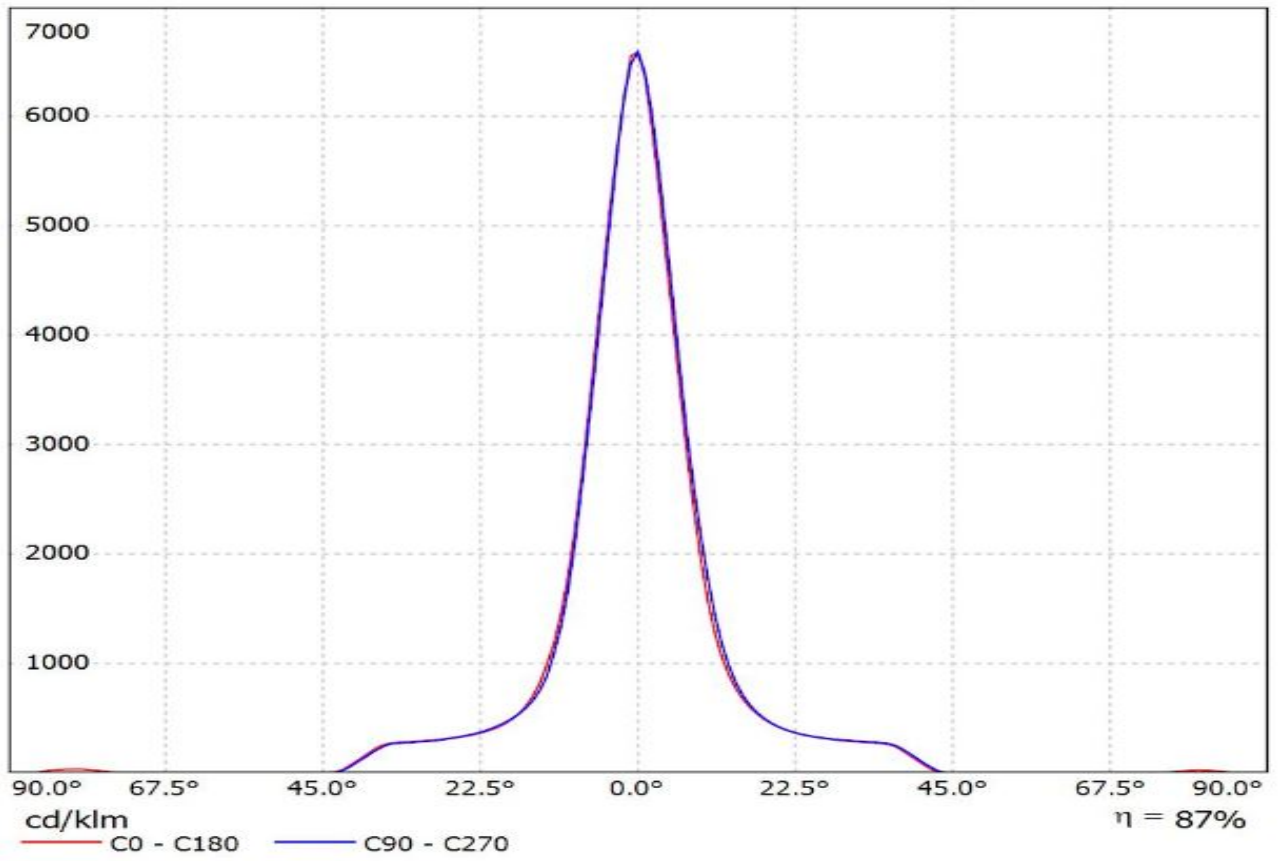

Luminaire: Ledil Oy CN13127_MIRELLA-50-S-PF_(Duris_S8)_SIMULATED
Lamps: 1 x Osram Duris S8

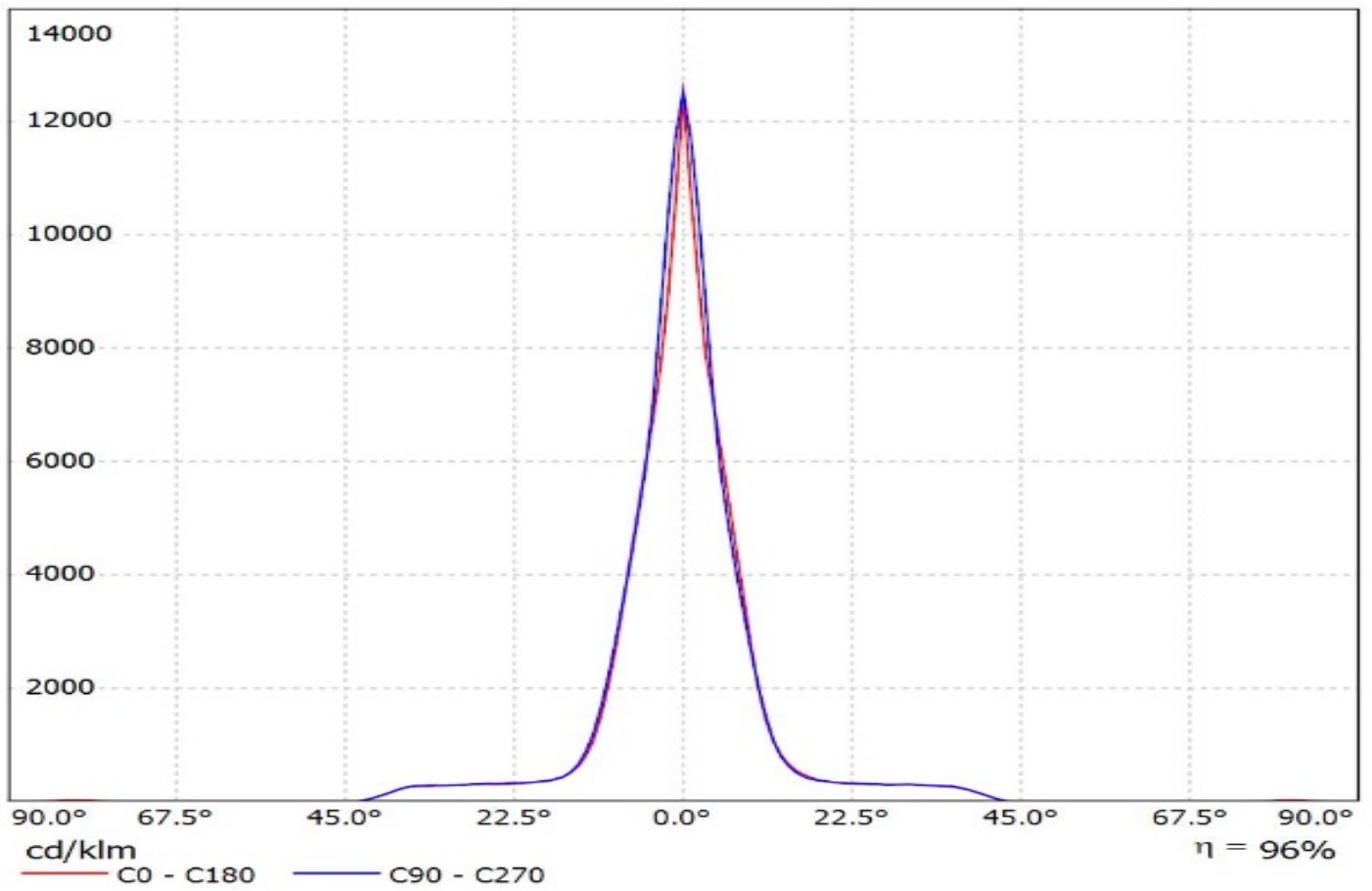

Luminaire: Ledil Oy CN13127_MIRELLA-50-S-PF_(Soleriq_S9)_SIMULATED
Lamps: 1 x Osram Soleriq S9 (GW KAJFB3.EM)

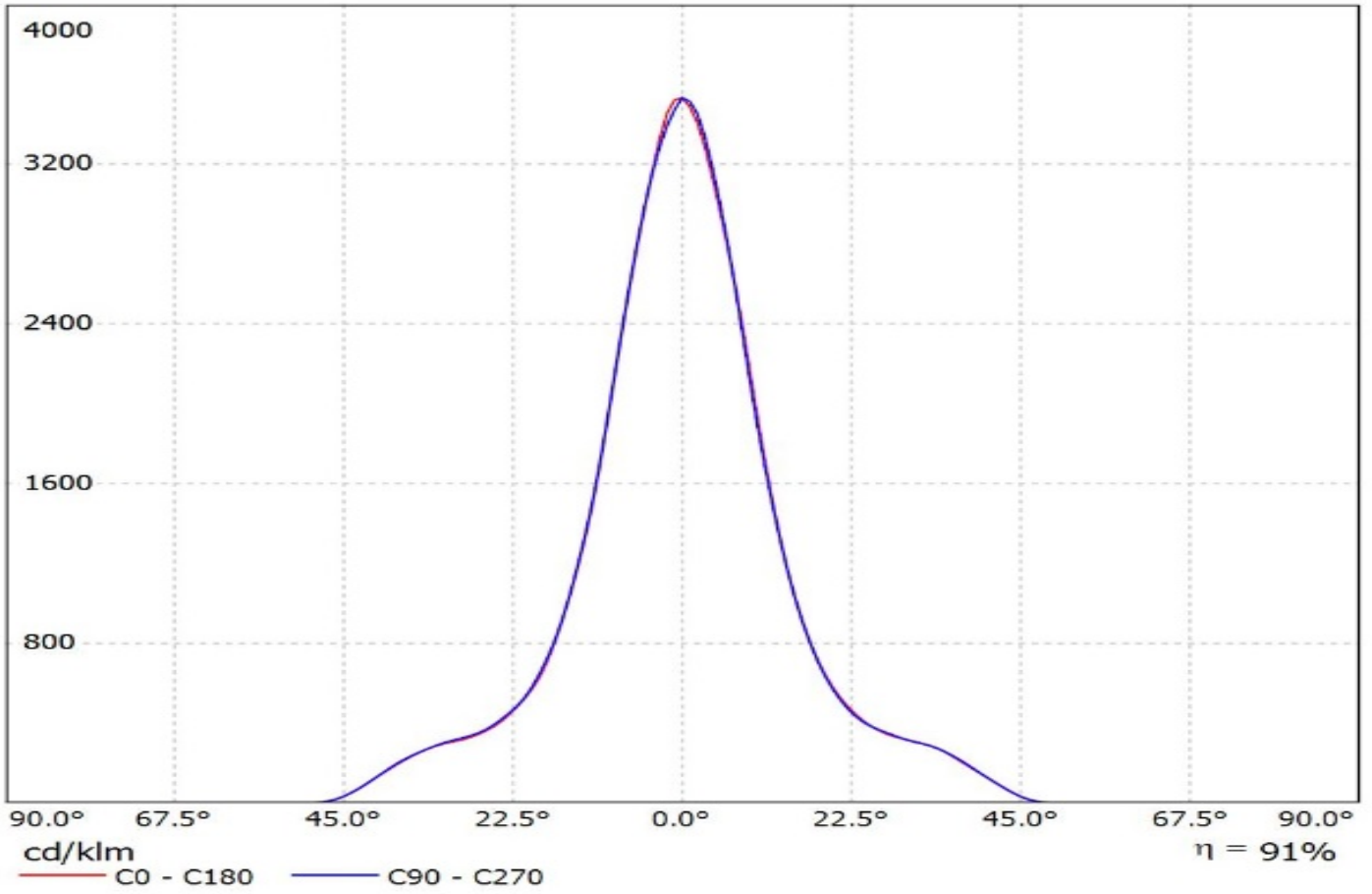

Luminaire: LEDil Oy CN13127_MIRELLA-50-S-PF_(ZC6) Efficiency=88%
Lamps: 1 x Seoul ZC6 (SDW81F1C) 422lm @ 100mA CCT=3100K P=3.4W I=100mA

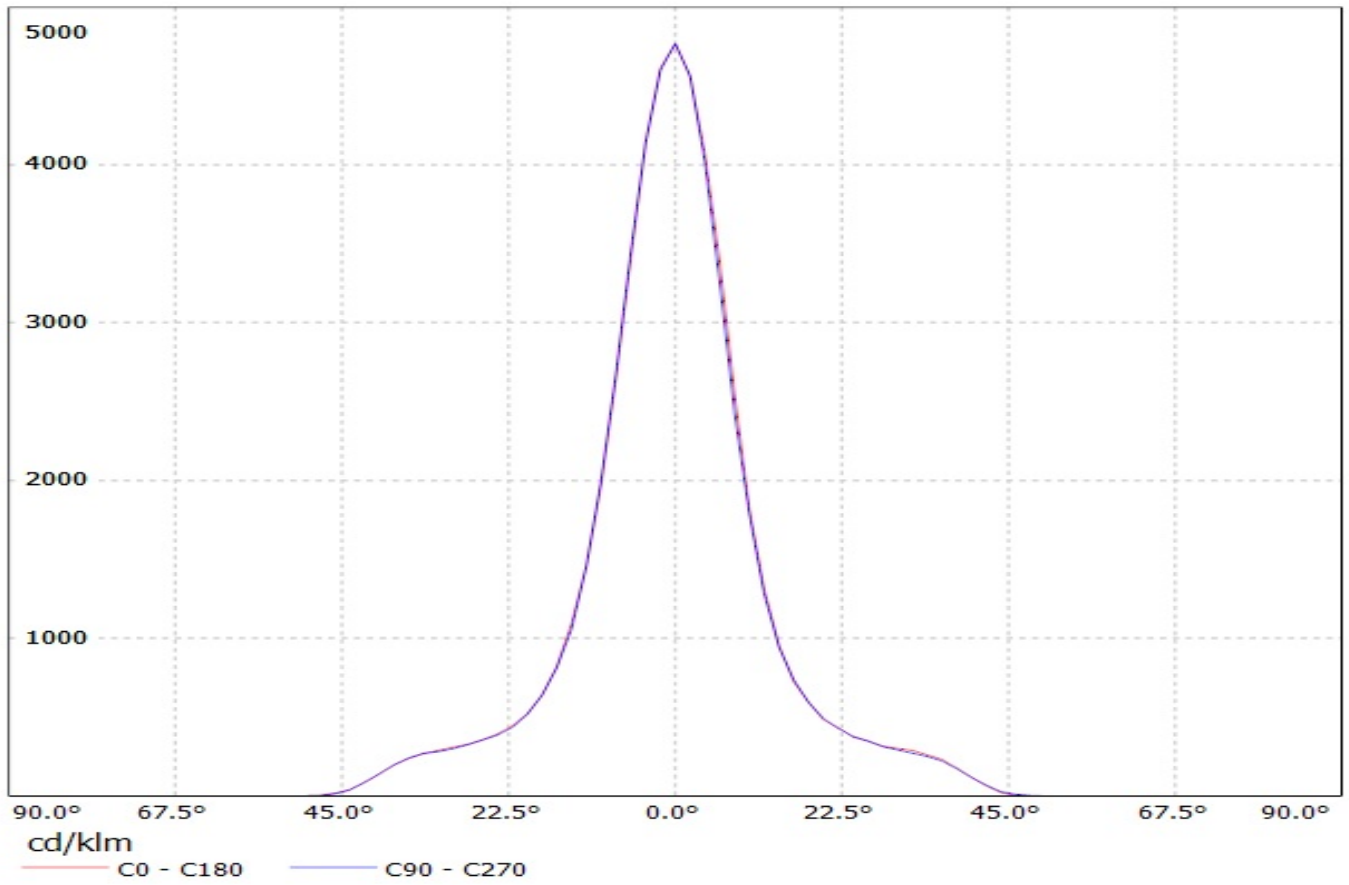

Luminaire: LEDiL Oy CN13127_MIRELLA-50-S-PF_(Mini_Zenigata_GW6BM) Eff.91.1%
Lamps: 1 x Mini_Zenigata_GW6BM (803.772lm@250mA)

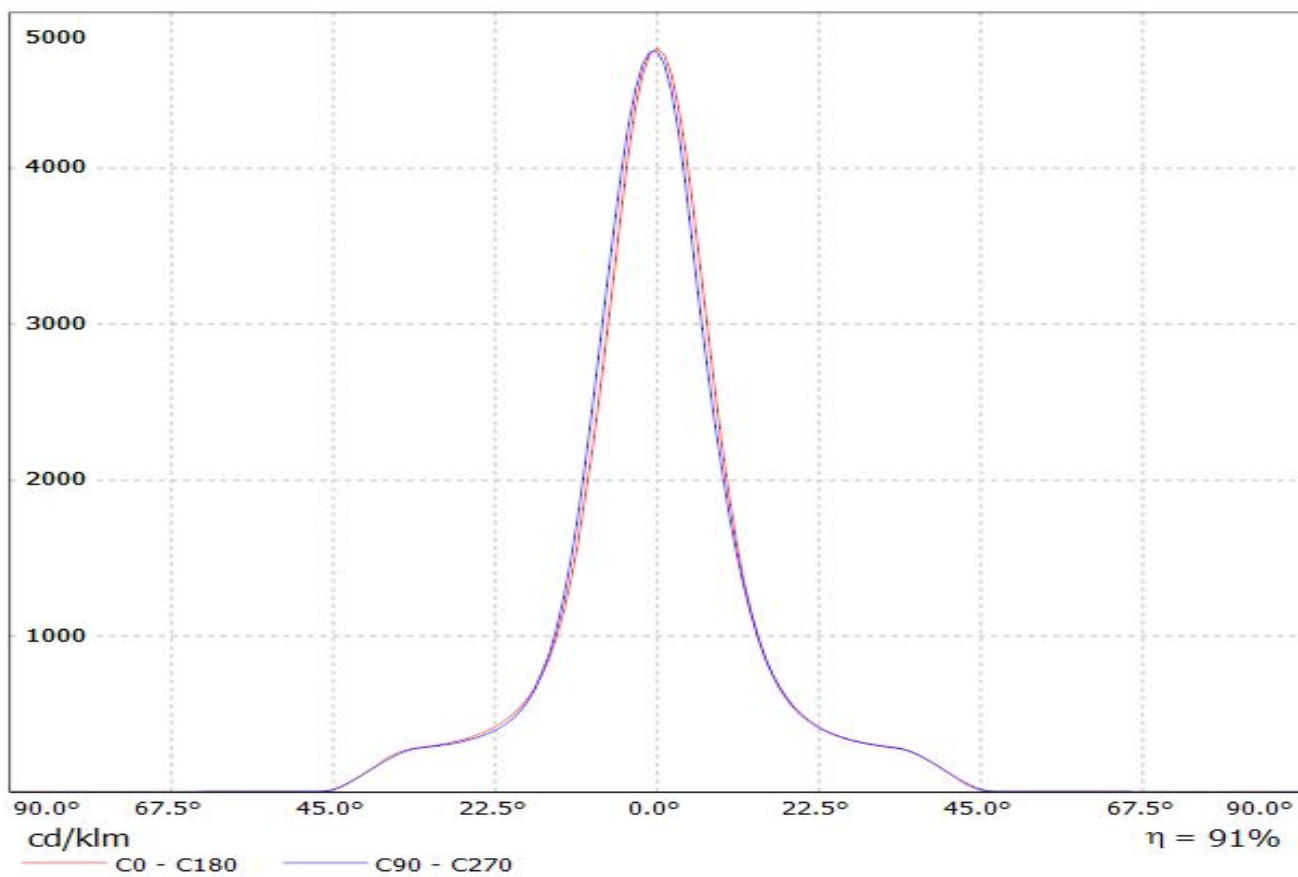

Luminaire: LEDiL Oy CN13127_MIRELLA-50-S-PF_(SLE-G5_LES-6)_(C13083_PF-SOCKET)
Lamps: 1 x Tridonic_SLE-G5_LES-6_468.743lm@100mA_P=3.3717W_I=0.100A

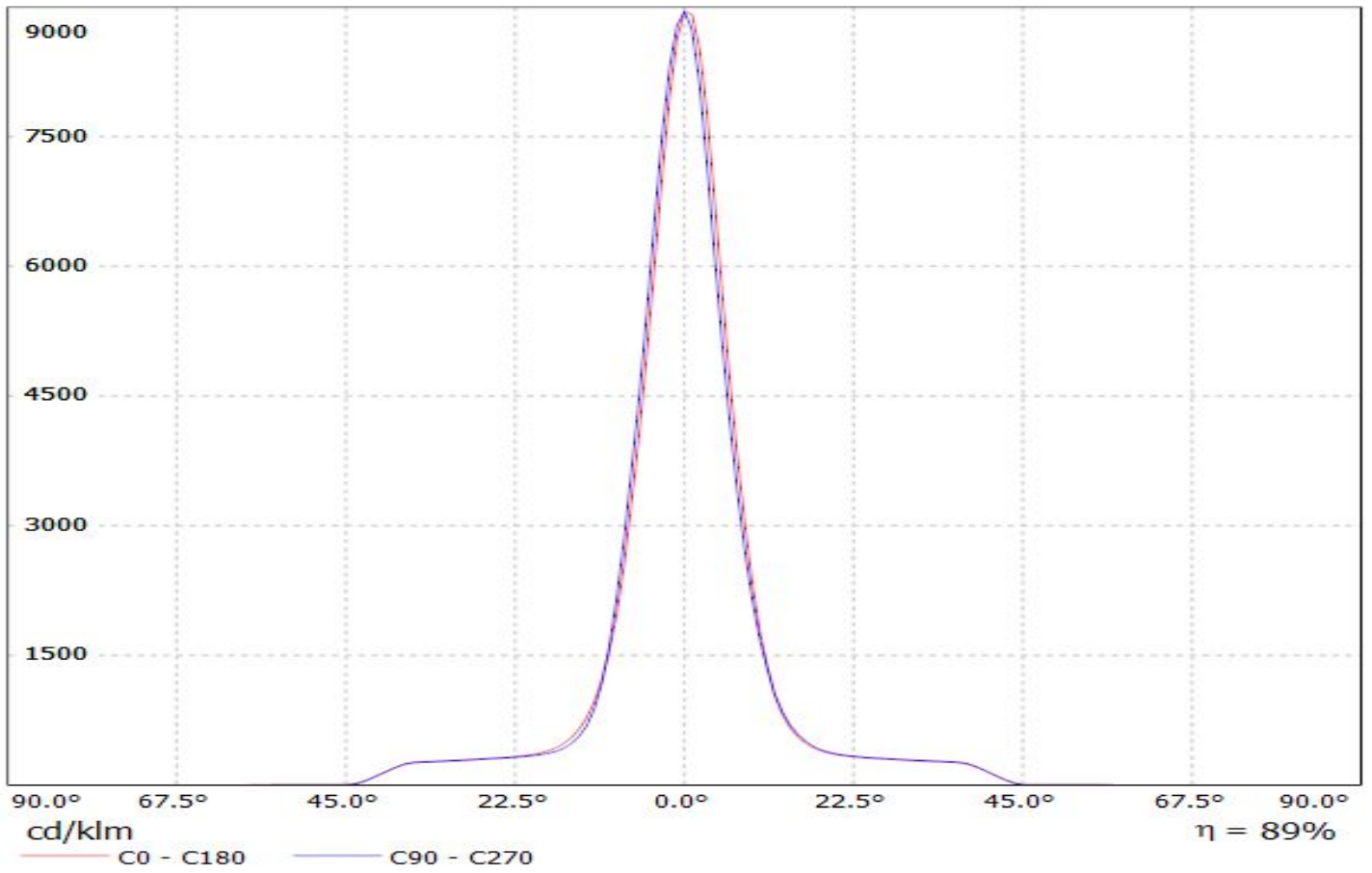

Luminaire: LEDiL Oy CN13127_MIRELLA-50-S-PF_(SLE-G5_LES-11)
Lamps: 1 x Tridonic_SLE-G5_LES-11_1166.25lm@250mA_P=8.3218W_I=0.250A

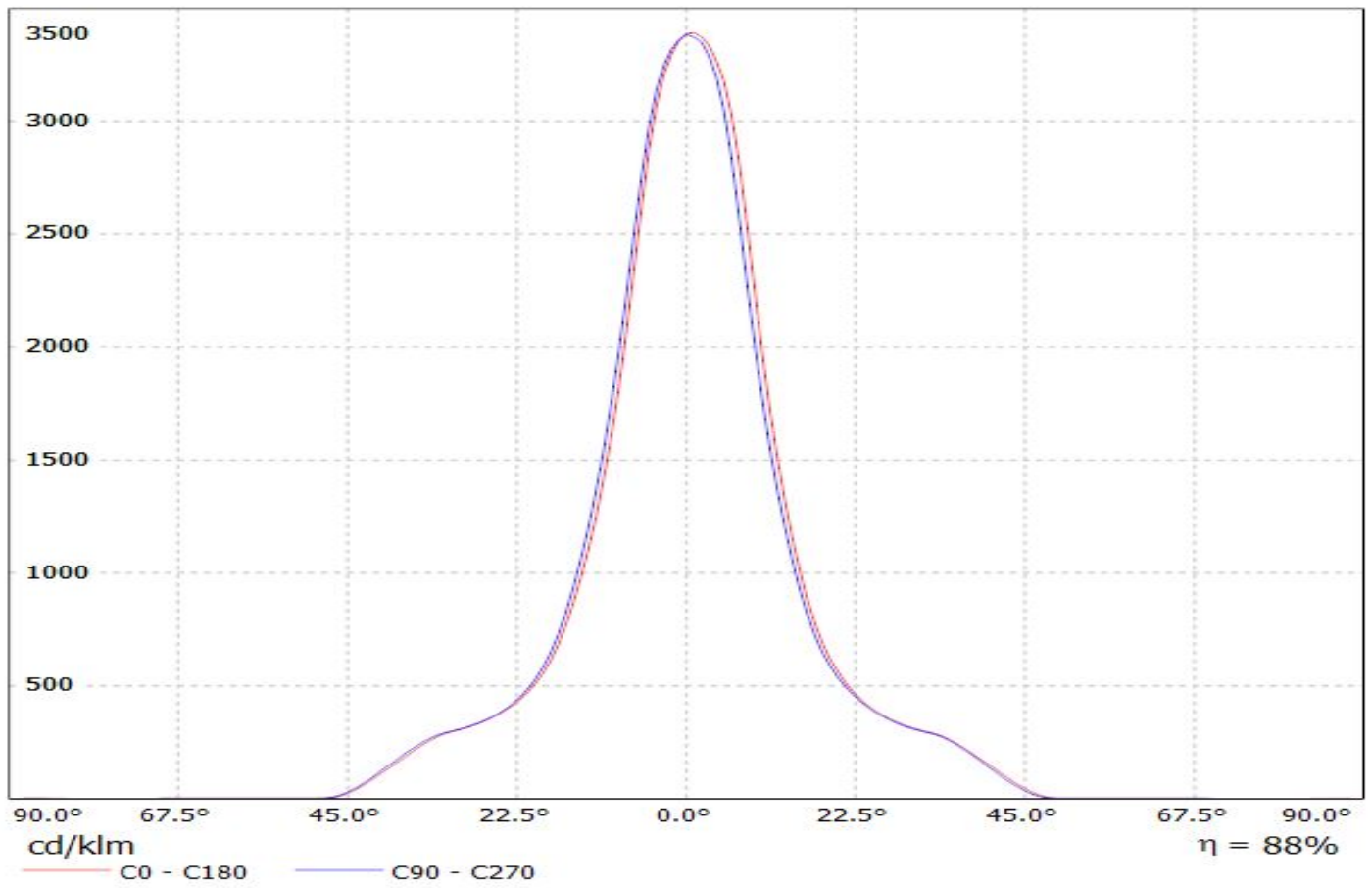

Luminaire: Ledil oy CN13127_MIRELLA-50-S-PF (Citizen CII010 113lm @ 100mA) Efficiency=88%
Lamps: 1 x Citizen CII010 113lm @ 100mA

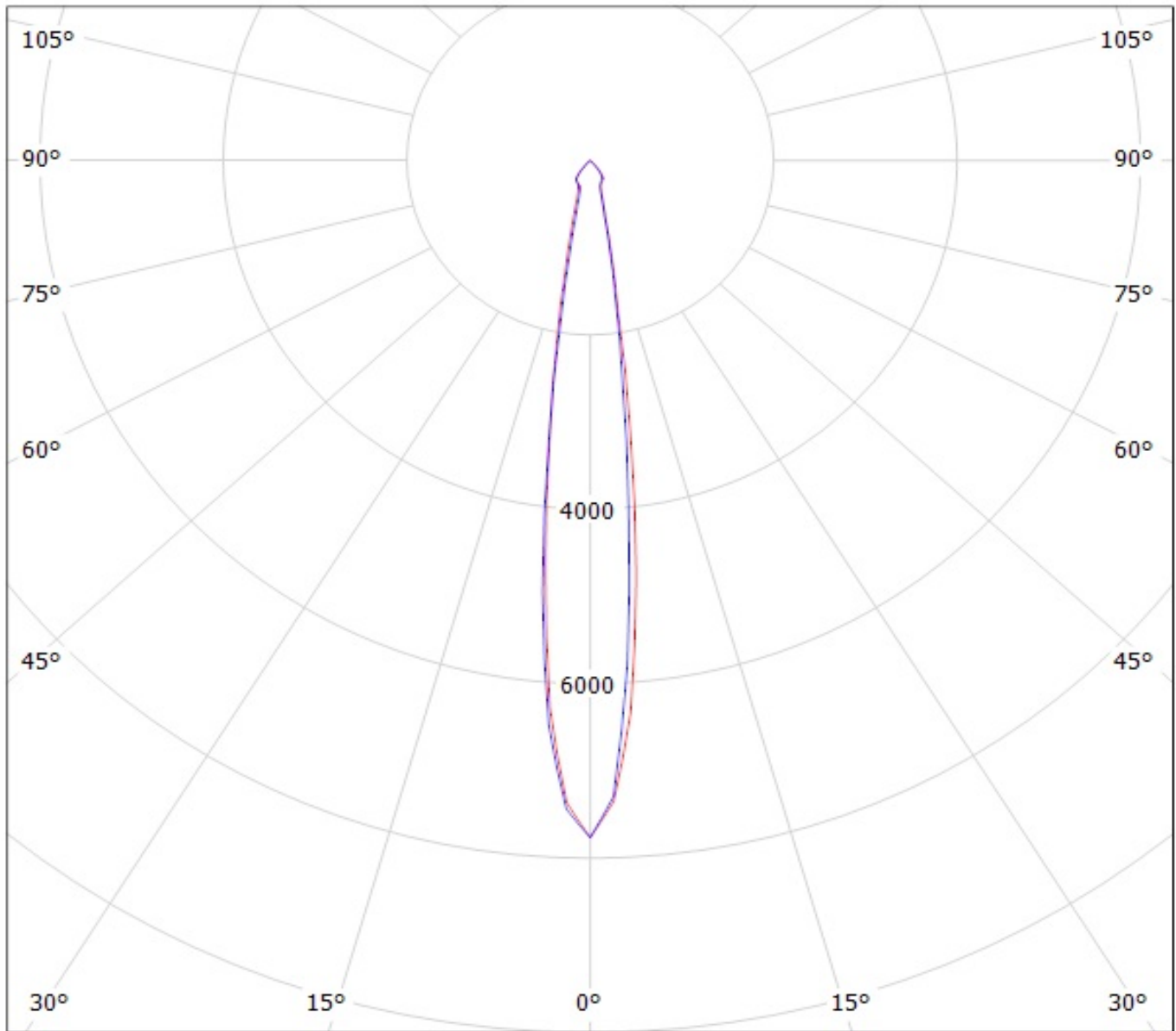

cd/klm

— C0 - C180

— C90 - C270

Luminaire: Ledil Oy CN13127_MIRELLA-50-S-PF (Citizen CII020 361lm @ 100mA) Efficiency=87%
Lamps: 1 x Citizen CII020 361lm @ 100mA

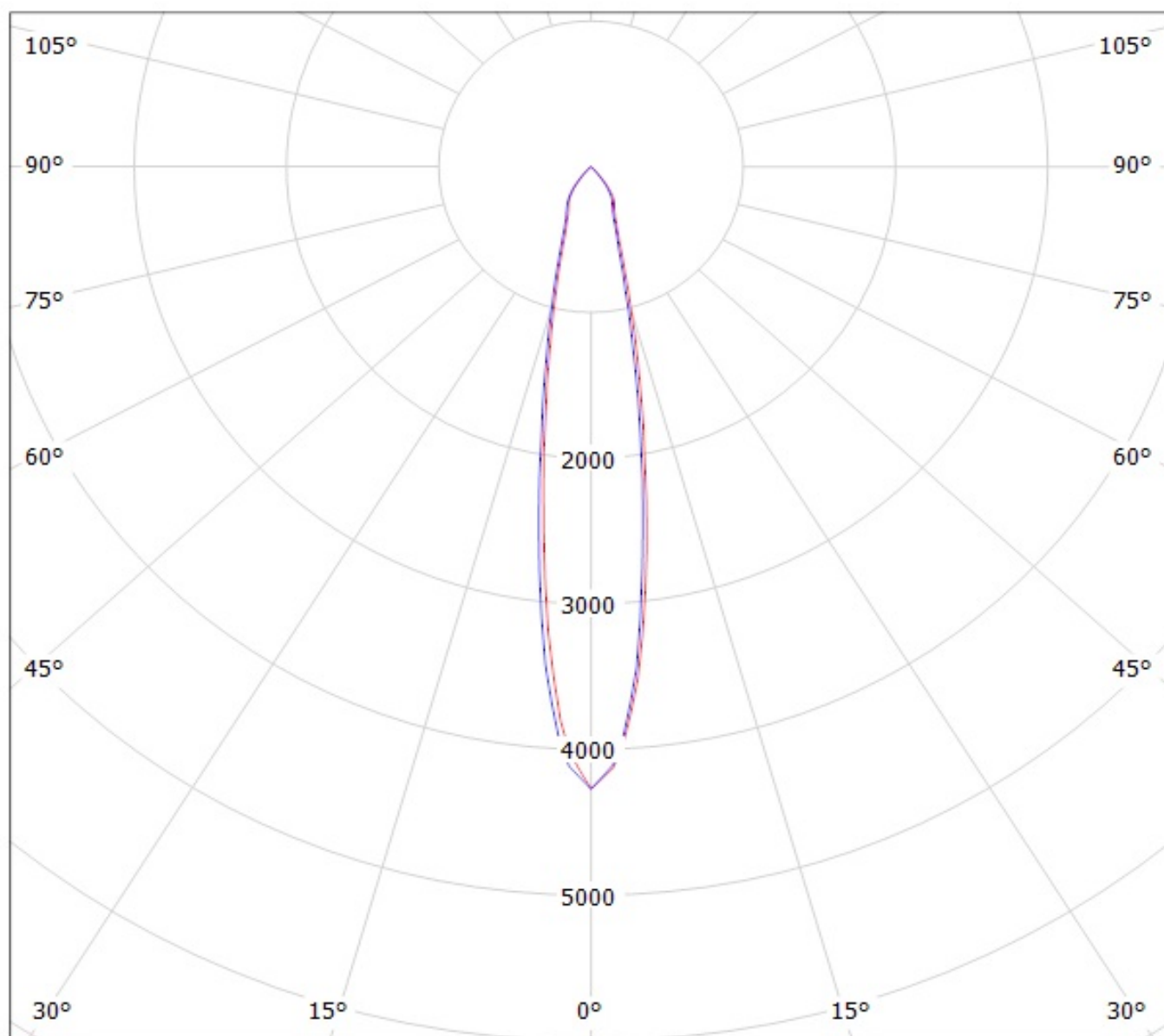

cd/klm

— C0 - C180

— C90 - C270

Luminaire: LEDiL Oy CN13127_MIRELLA-50-S-PF_(CLU700)

Lamps: 1 x Citizen_CLU700_C13083_PF-SOCKET_394.785lm@100mA_P=2.92999W_I=0.1044A

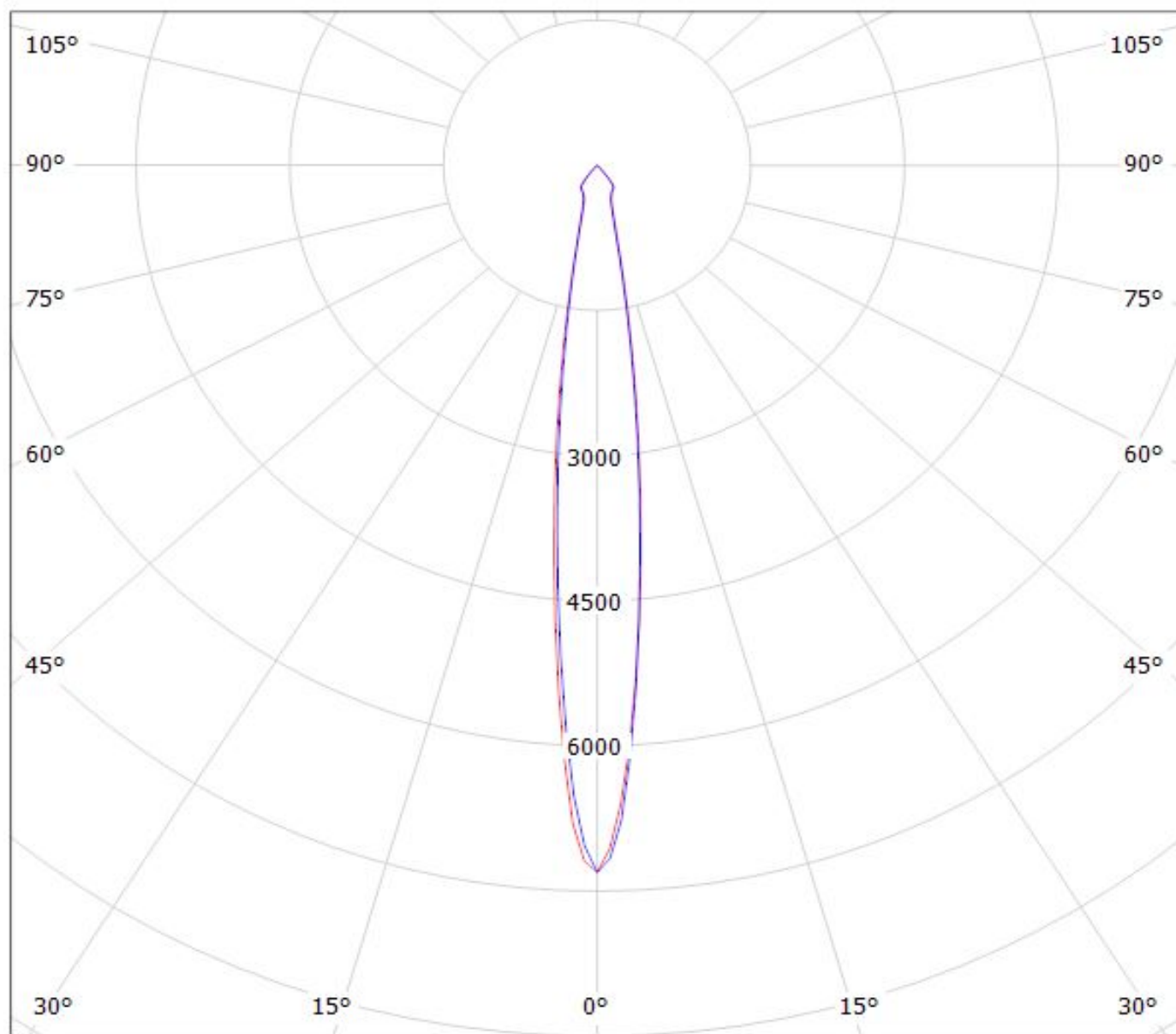

cd/klm

— C0 - C180

— C90 - C270

$\eta = 89\%$

Luminaire: Ledil oy CN13127_MIRELLA-50-S-PF (Cree MT-G 714lm @ 250mA) Efficiency=90%
Lamps: 1 x Cree MT-G 714lm @ 250mA

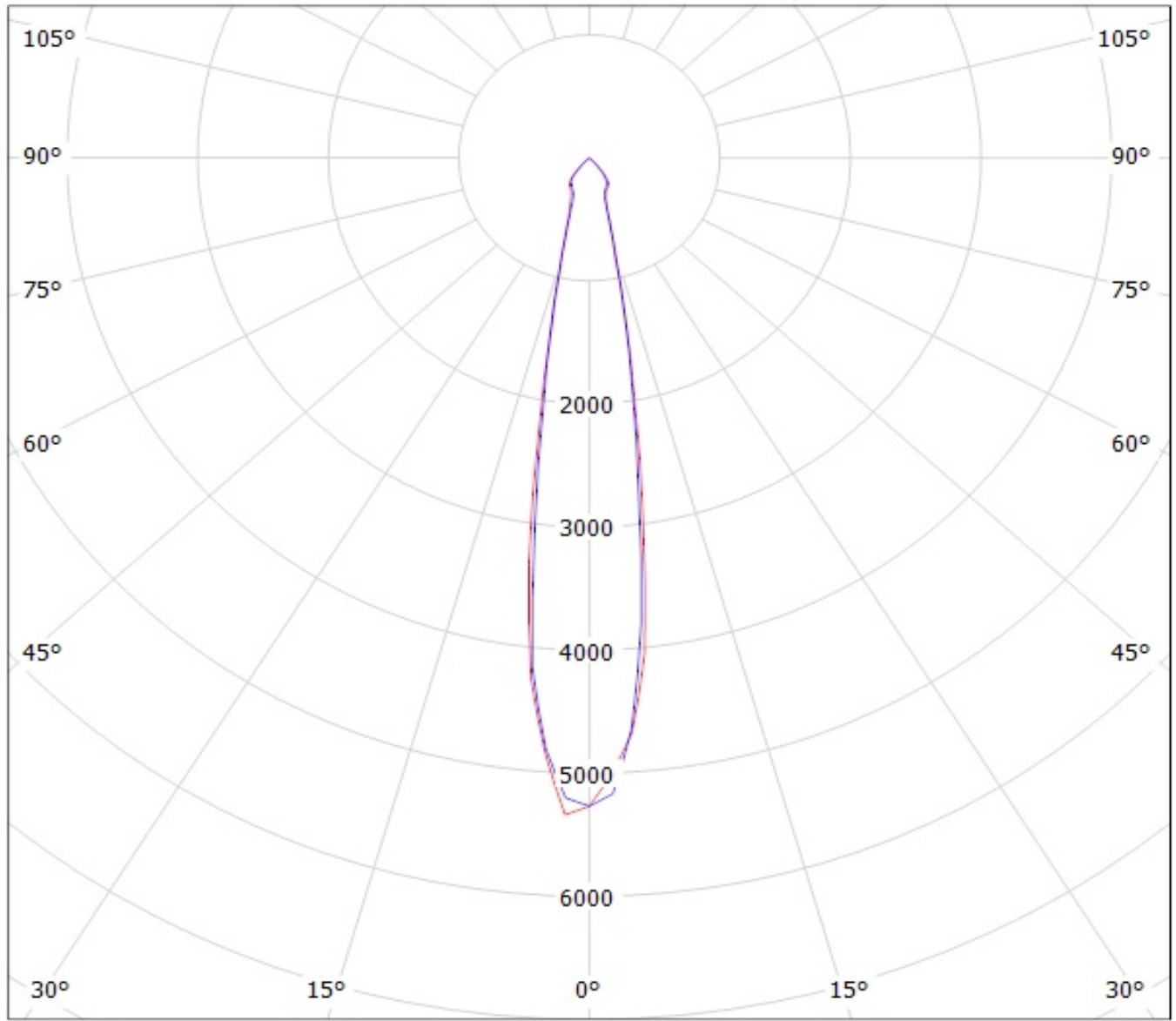

cd/klm

— C0 - C180

— C90 - C270

Luminaire: Ledil Oy CN13127_MIRELLA-50-S-PF (Cree MT-G2 172lm @ 250mA) Efficiency=88%
Lamps: 1 x Cree MT-G2 172lm @ 250mA

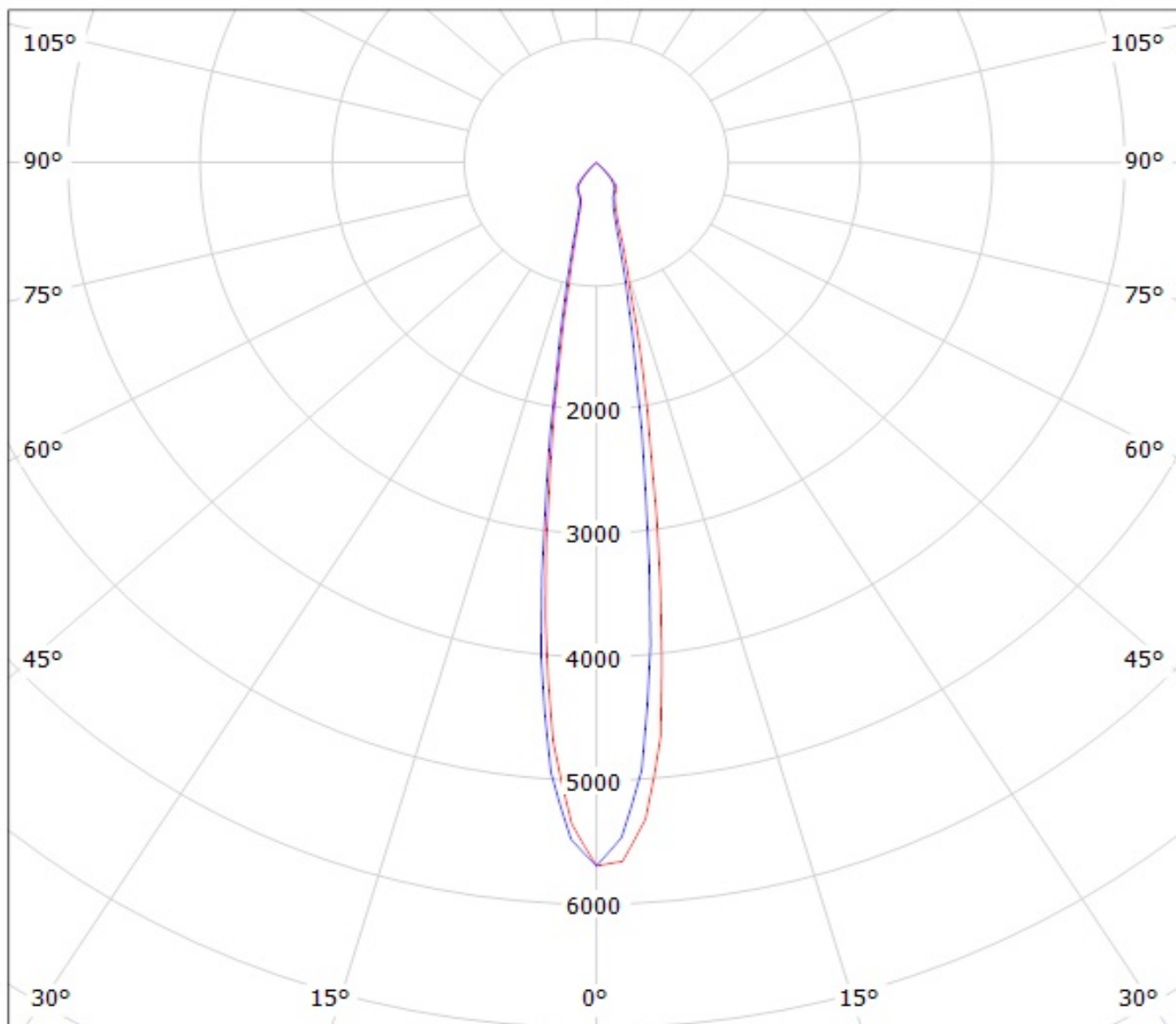

cd/klm

— C0 - C180

— C90 - C270

Luminaire: LEDiL Oy CN13127_MIRELLA-50-S-PF_(MK-R) Eff.87.4%
Lamps: 1 x CREE_MK-R_361lm@250mA_P=2.84311W_I=249.9mA

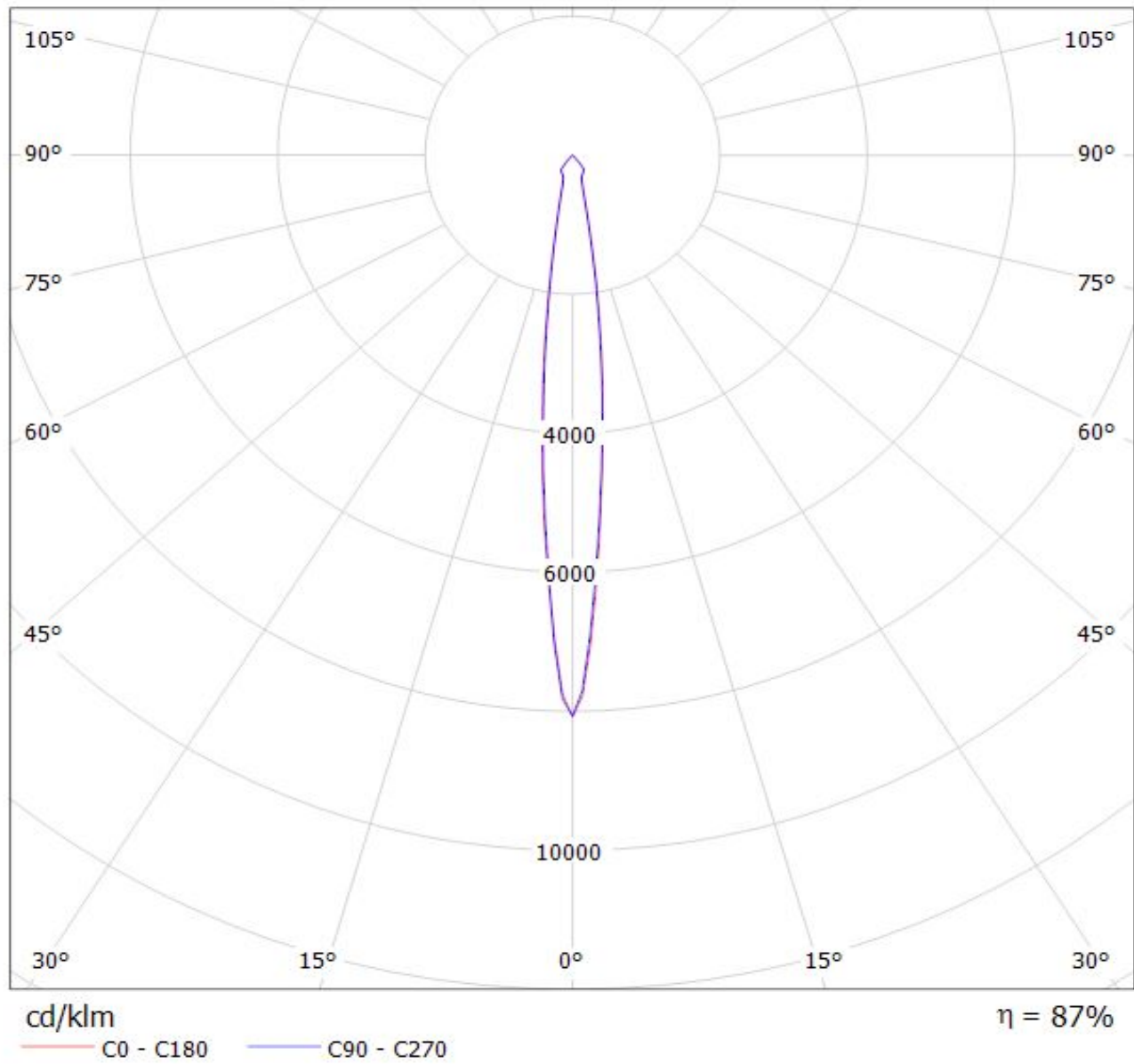

Luminaire: LEDiL Oy CN13127_MIRELLA-50-S-PF_(XHP70)
Lamps: 1 x Cree_XHP70_262.055lm@250mA_P=1.38275W_I=249.9mA

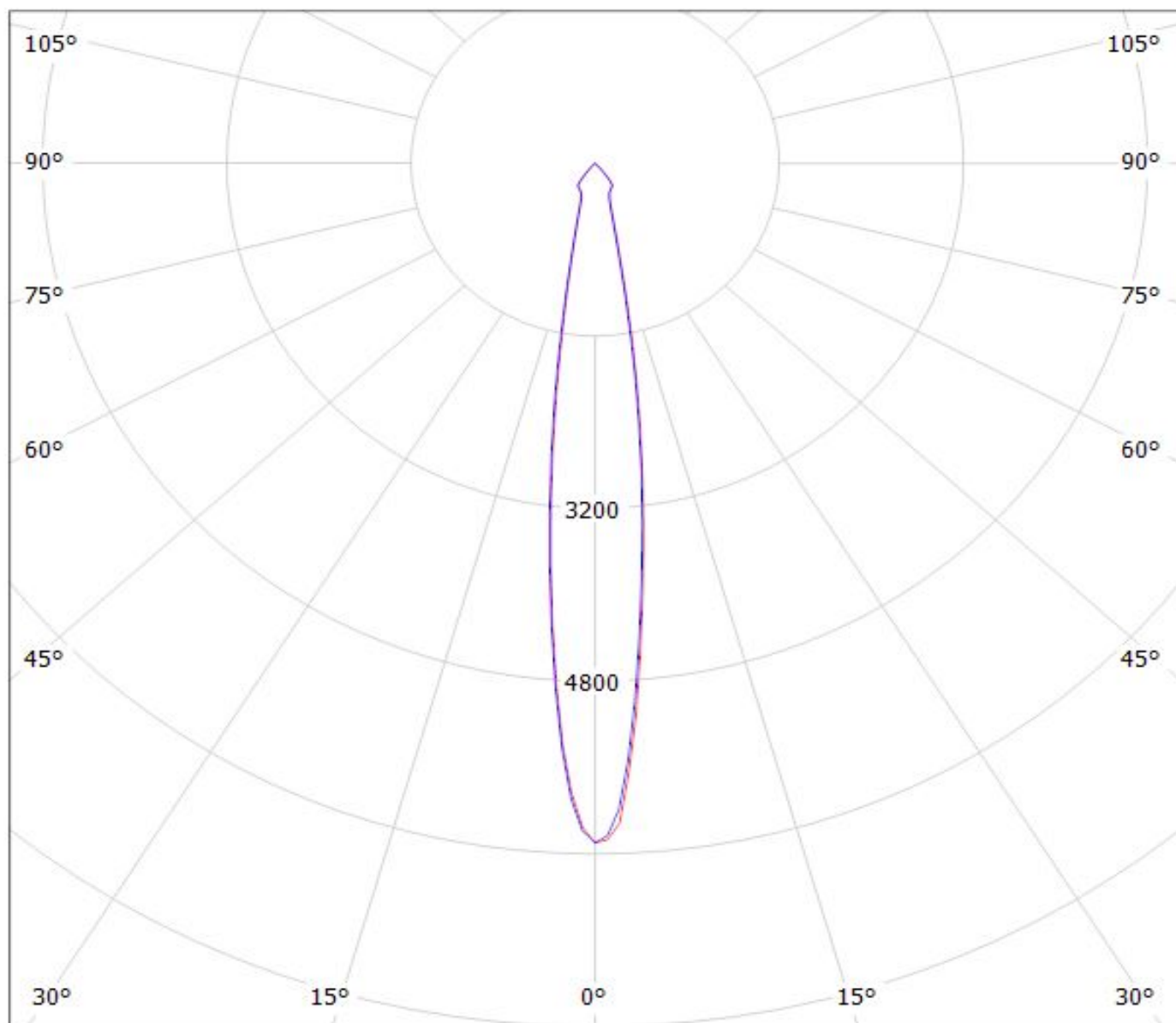

cd/klm

— C0 - C180

— C90 - C270

$\eta = 88\%$

Luminaire: LEDiL Oy CN13127_MIRELLA-50-S-PF_(Cree_XHP50_WW)
Lamps: 1 x Cree_XHP50_WW_196.271lm@250mA_P=1.39897W_I=0.2499A

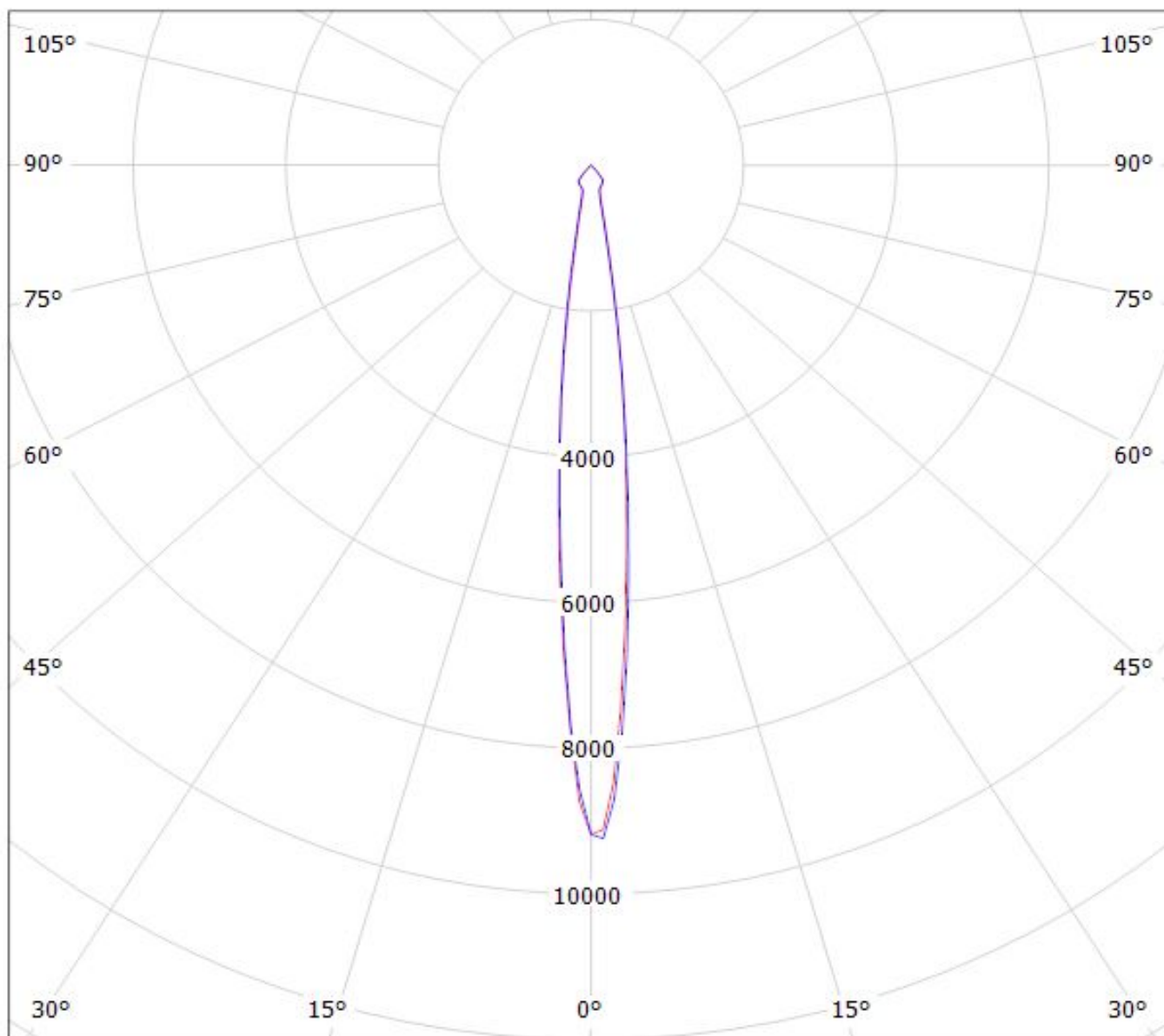

cd/klm

— C0 - C180 — C90 - C270

$\eta = 89\%$

Luminaire: Ledil CN13127_MIRELLA-50-S-PF_(MHD-G)
Lamps: 1 x Cree MHD-G_530.44lm@100mA_P=3.0W_I=0.100A

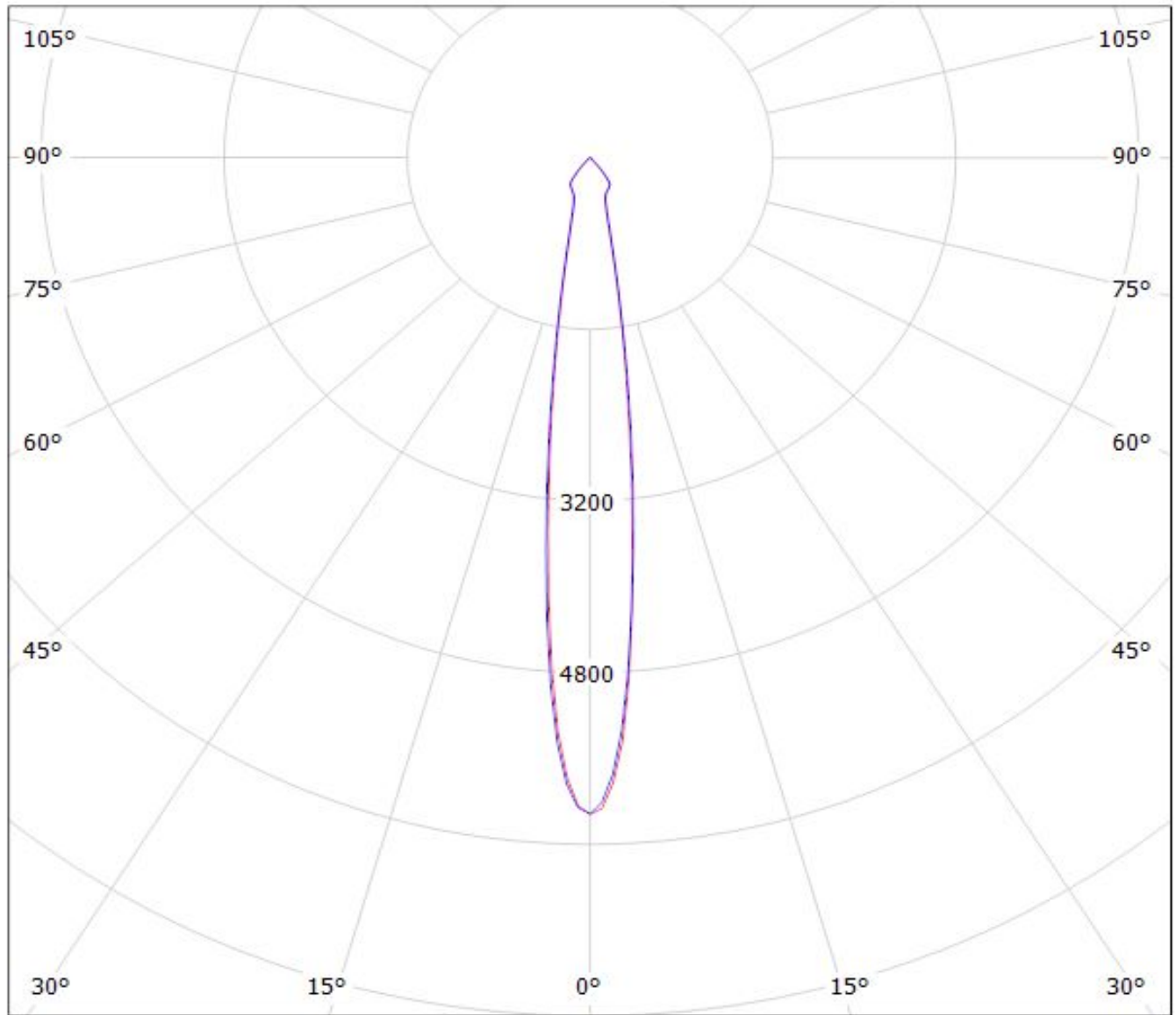

cd/klm

— C0 - C180

— C90 - C270

$\eta = 93\%$

Luminaire: LEDil Oy CN13127_MIRELLA-50-S-PF_(CXM-6) Efficiency=86%
Lamps: 1 x Luminus XNOVA CXM-6 (437lm @ 120mA) CCT=3200K P=4.2W I=120mA

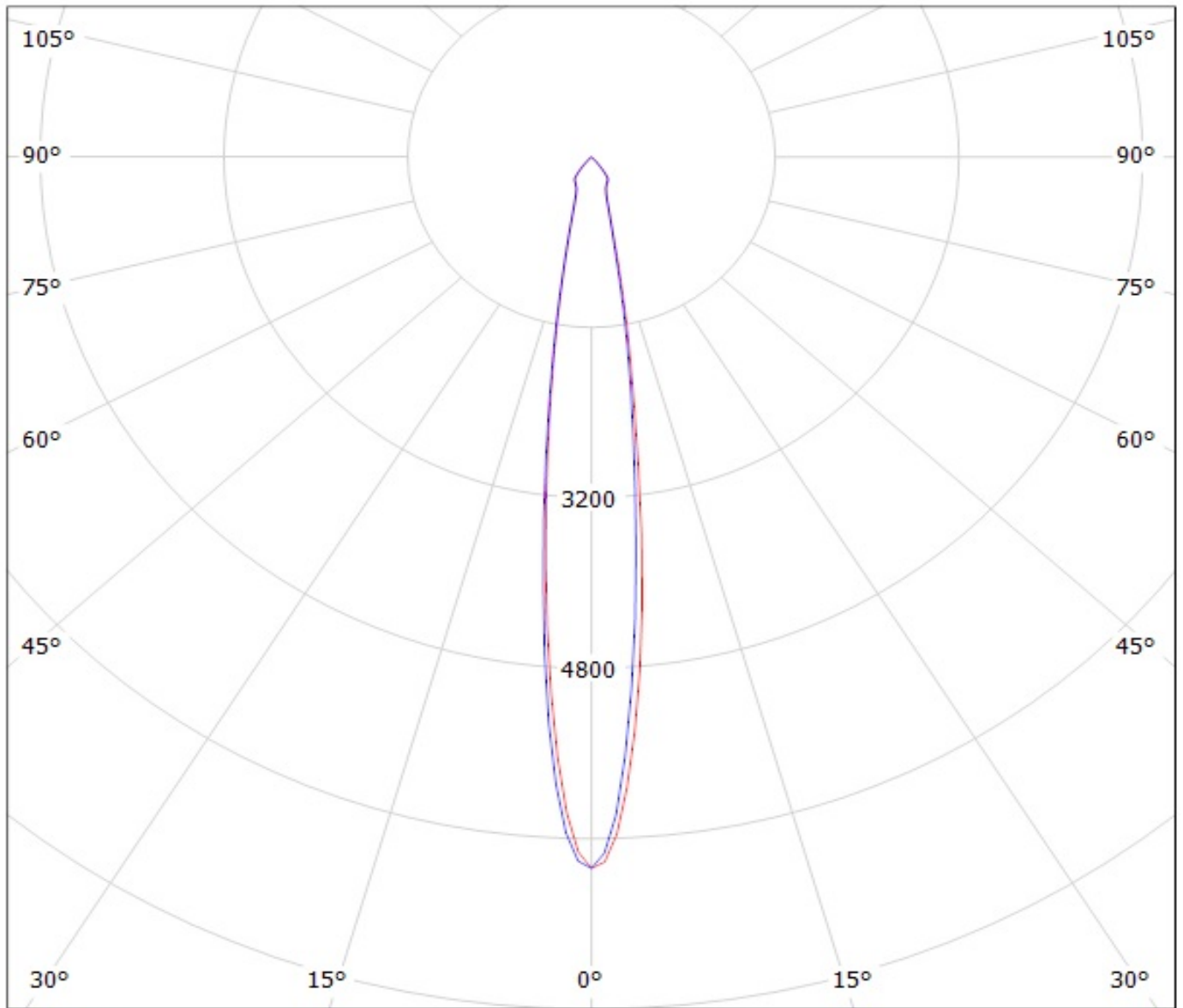

cd/klm

— C0 - C180

— C90 - C270

Luminaire: LEDil Oy CN13127_MIRELLA-50-S-PF_(CXM-7) Efficiency=87%
Lamps: 1 x Luminus XNOVA CXM-7 (522lm @ 160mA) CCT=2900K P=5.6W I=160mA

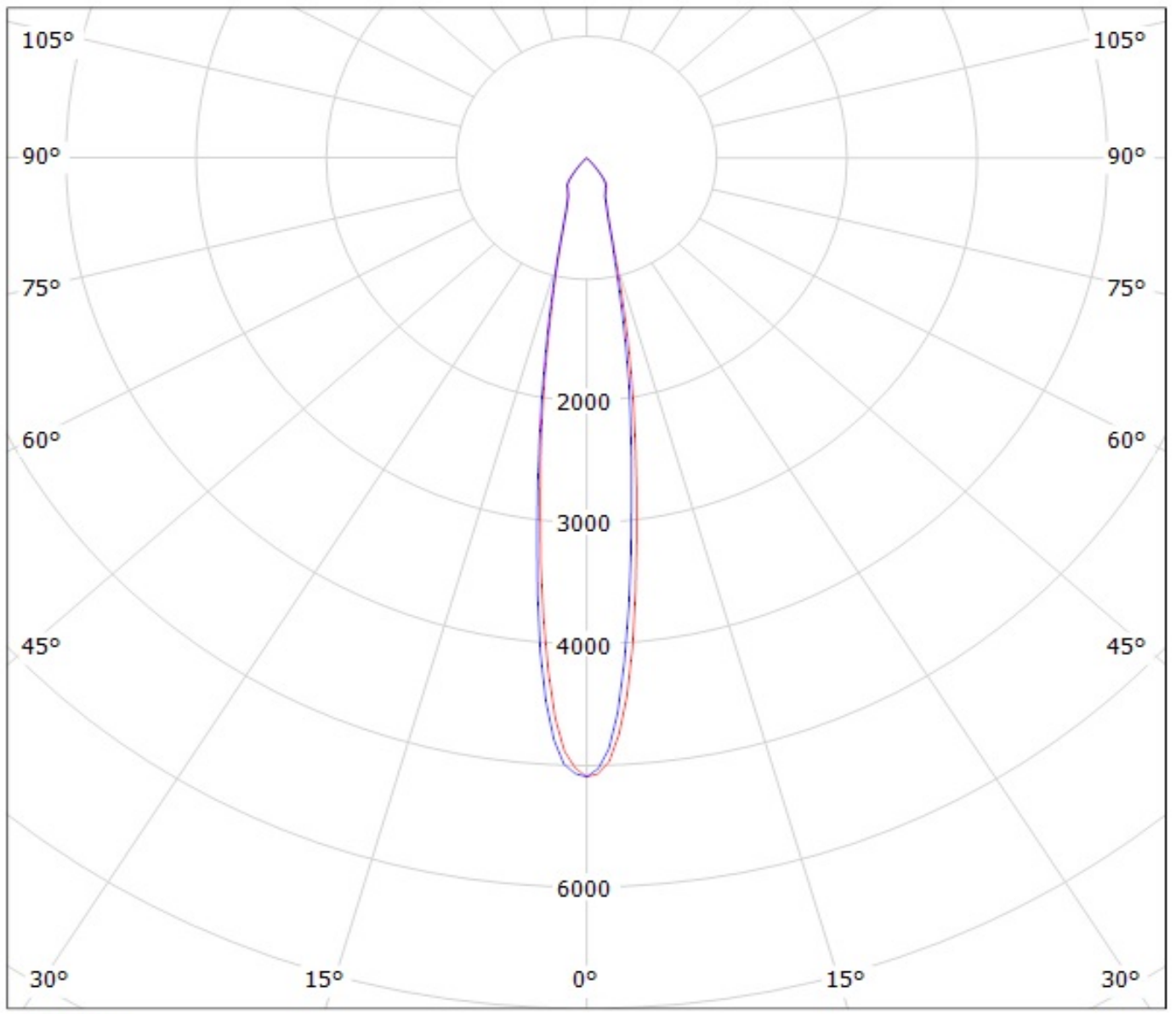

cd/klm
— C0 - C180 — C90 - C270

Luminaire: Ledil CN13127_MIRELLA-50-S-PF_(Duris_S10)

Lamps: 1 x Osram_Duris_S10_(GWP7LM32.CM)_298.59lm@100mA_P=2.52277W_I=0.1A

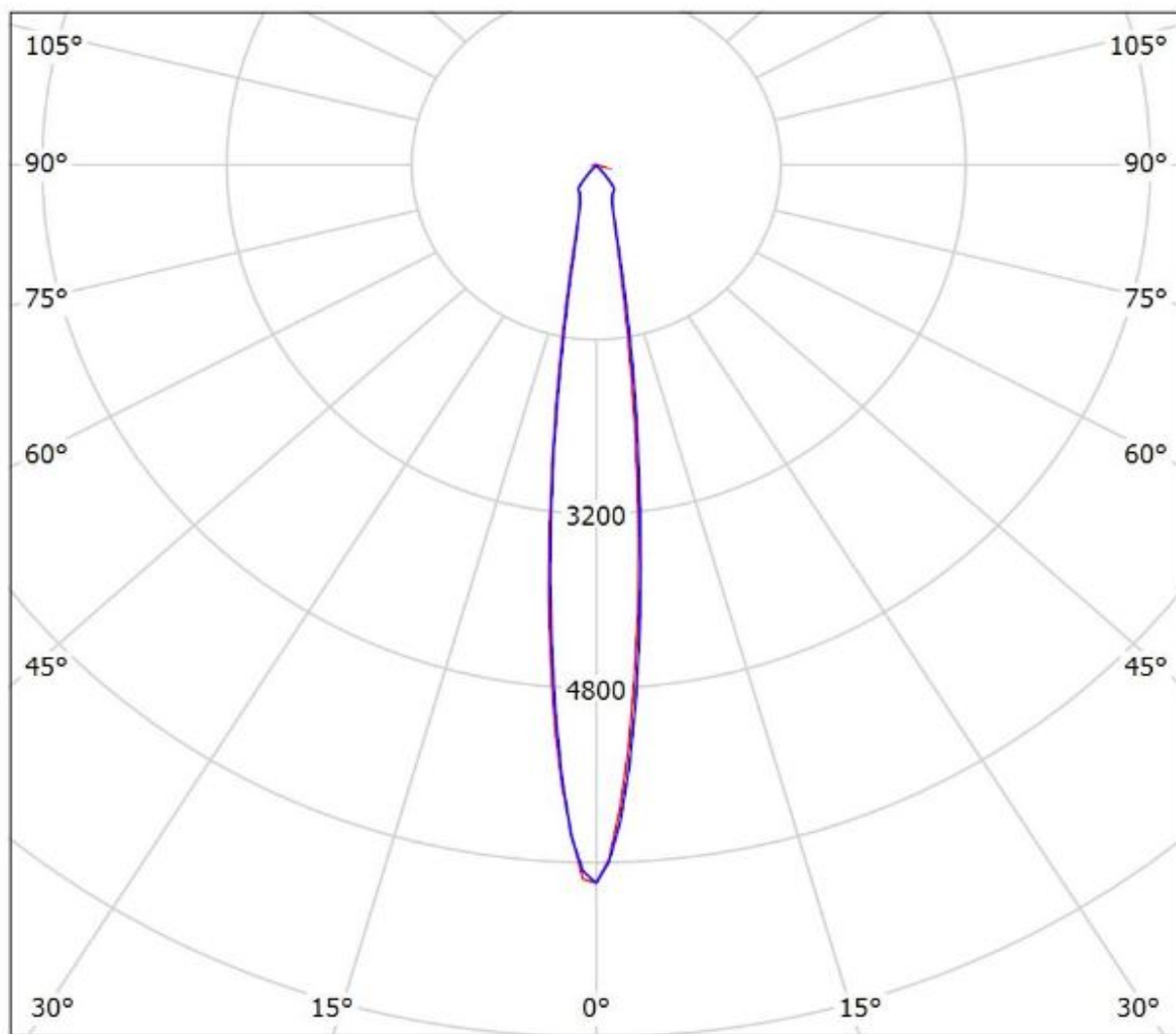

cd/klm

$\eta = 87\%$

— C0 - C180 — C90 - C270

Luminaire: Ledil Oy CN13127_MIRELLA-50-S-PF_(Duris_S8)_SIMULATED
Lamps: 1 x Osram Duris S8

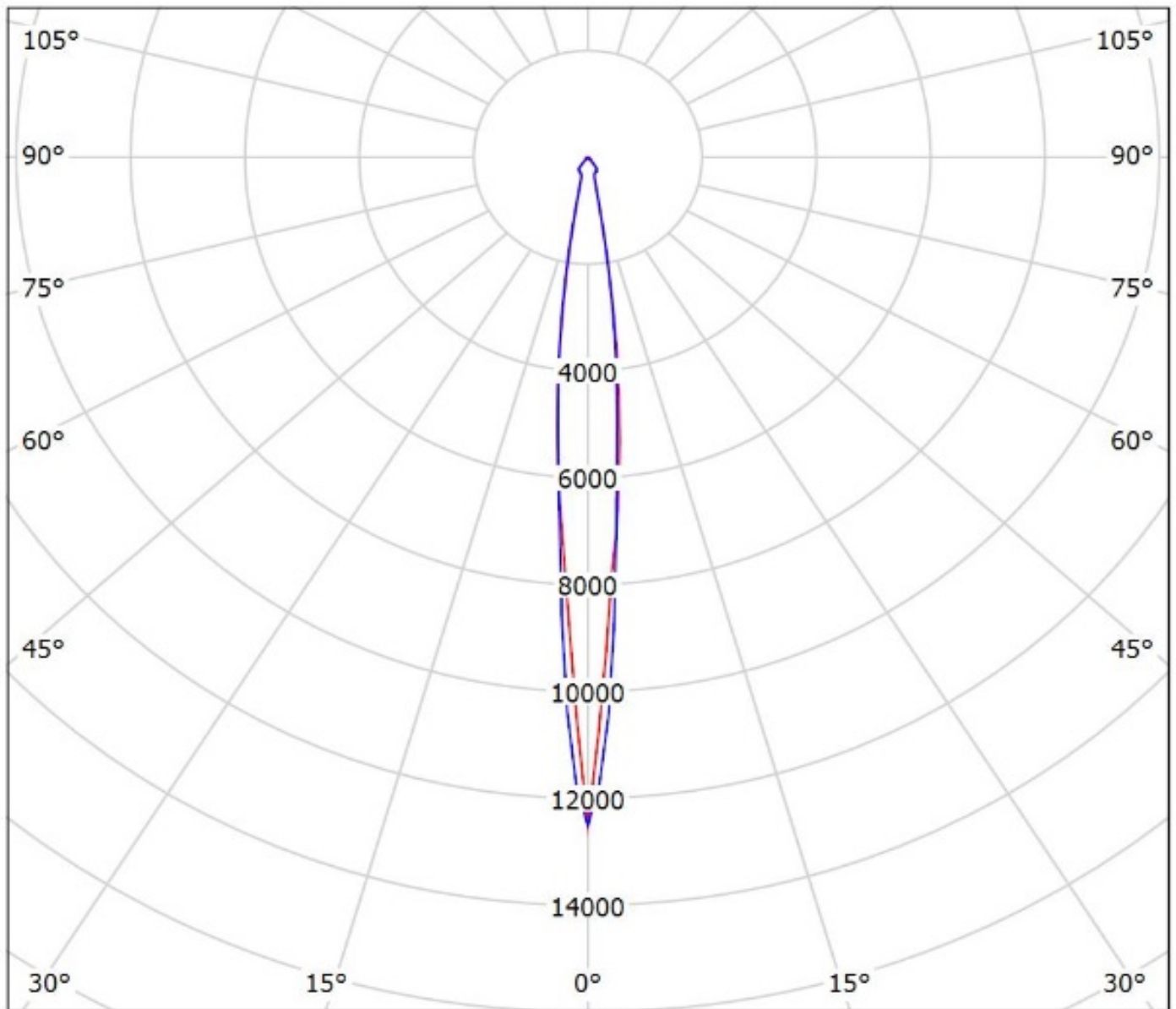

cd/klm

— C0 - C180 — C90 - C270

$\eta = 96\%$

Luminaire: Ledil Oy CN13127_MIRELLA-50-S-PF_(Soleriq_S9)_SIMULATED
Lamps: 1 x Osram Soleriq S9 (GW KAJFB3.EM)

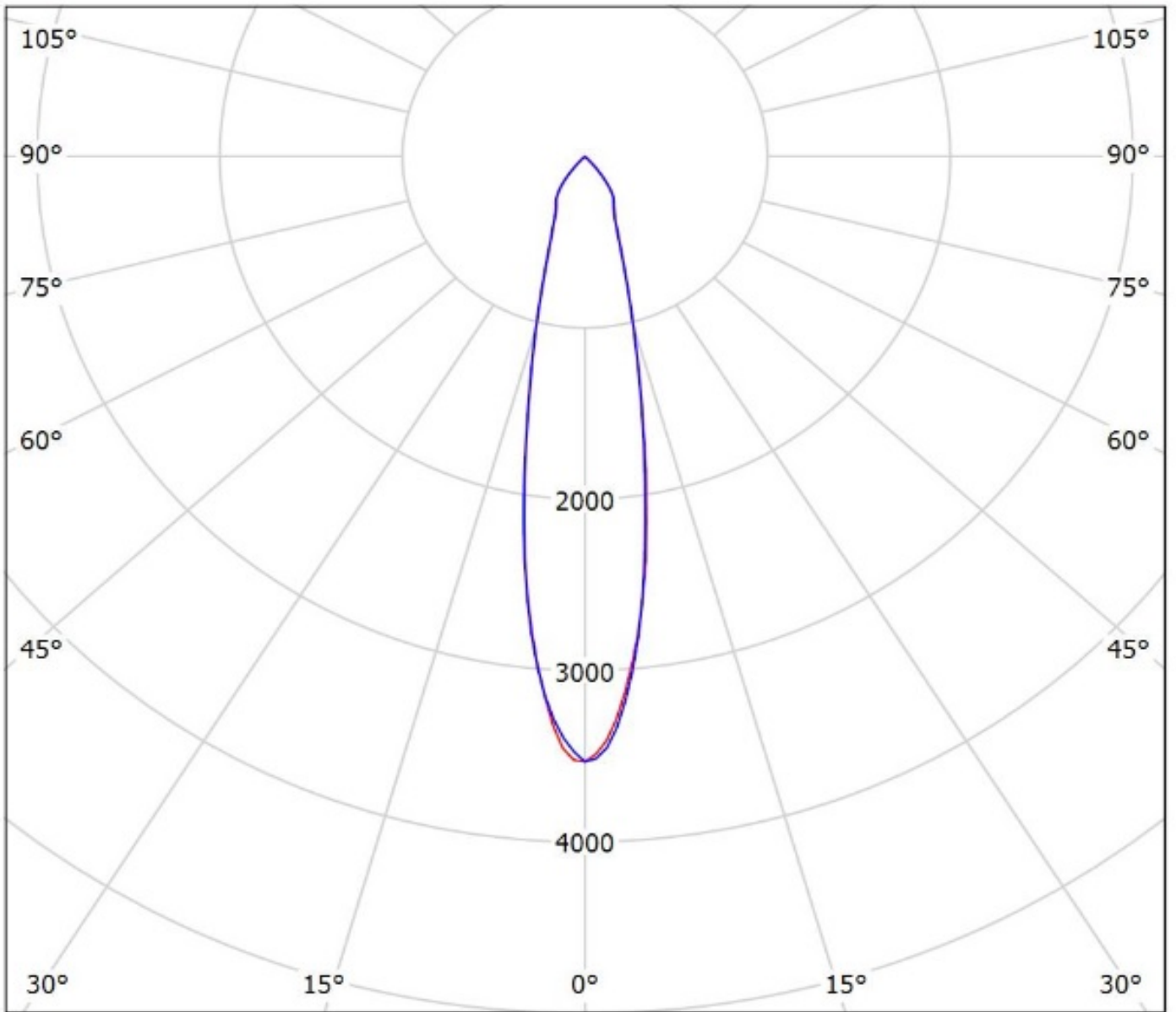

cd/klm

— C0 - C180 — C90 - C270

$\eta = 91\%$

Luminaire: LEDil Oy CN13127_MIRELLA-50-S-PF_(ZC6) Efficiency=88%
Lamps: 1 x Seoul ZC6 (SDW81F1C) 422lm @ 100mA CCT=3100K P=3.4W I=100mA

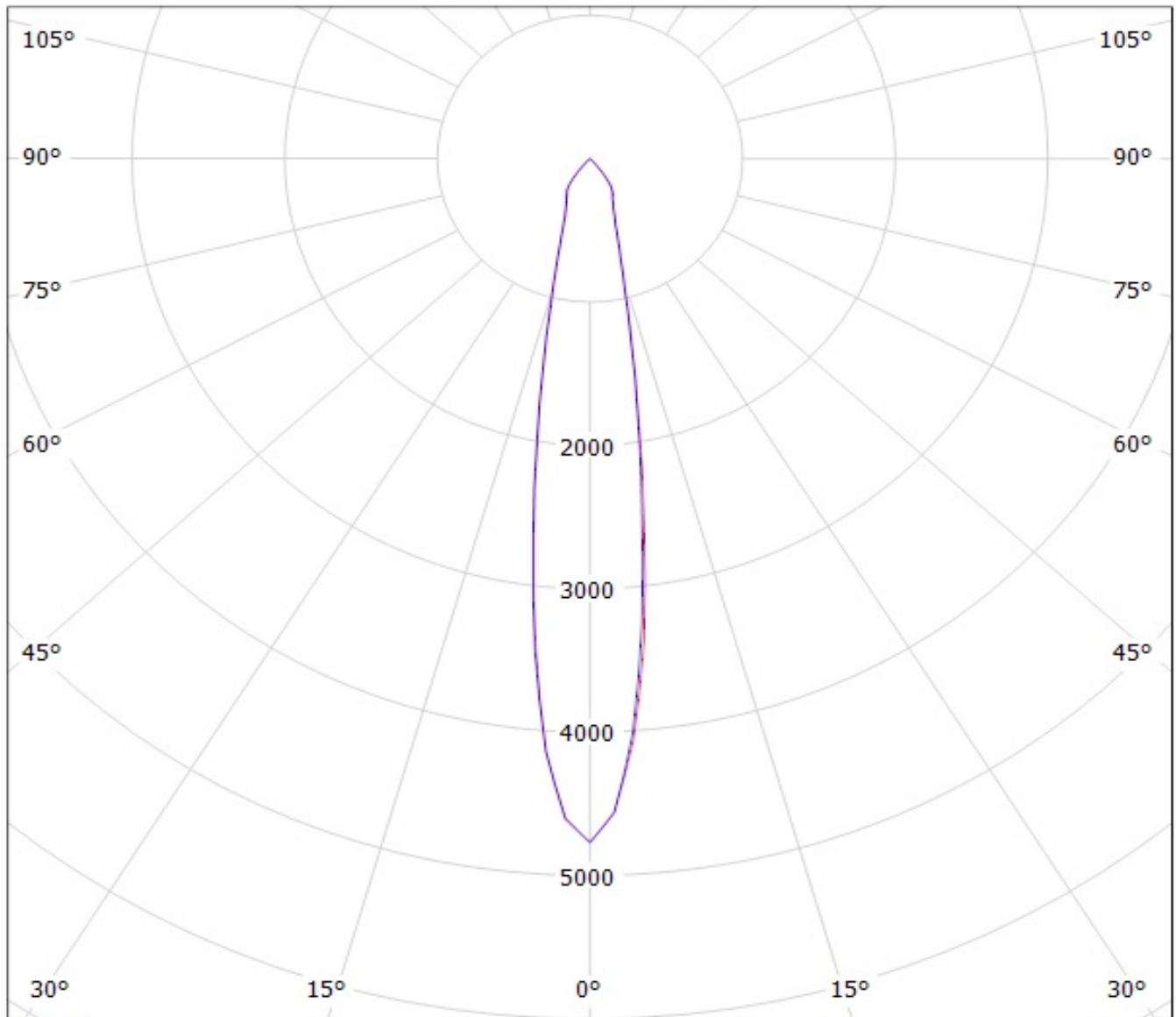

cd/klm

— C0 - C180 — C90 - C270

Luminaire: LEDiL Oy CN13127_MIRELLA-50-S-PF_(Mini_Zenigata_GW6BM) Eff.91.1%
Lamps: 1 x Mini_Zenigata_GW6BM (803.772lm@250mA)

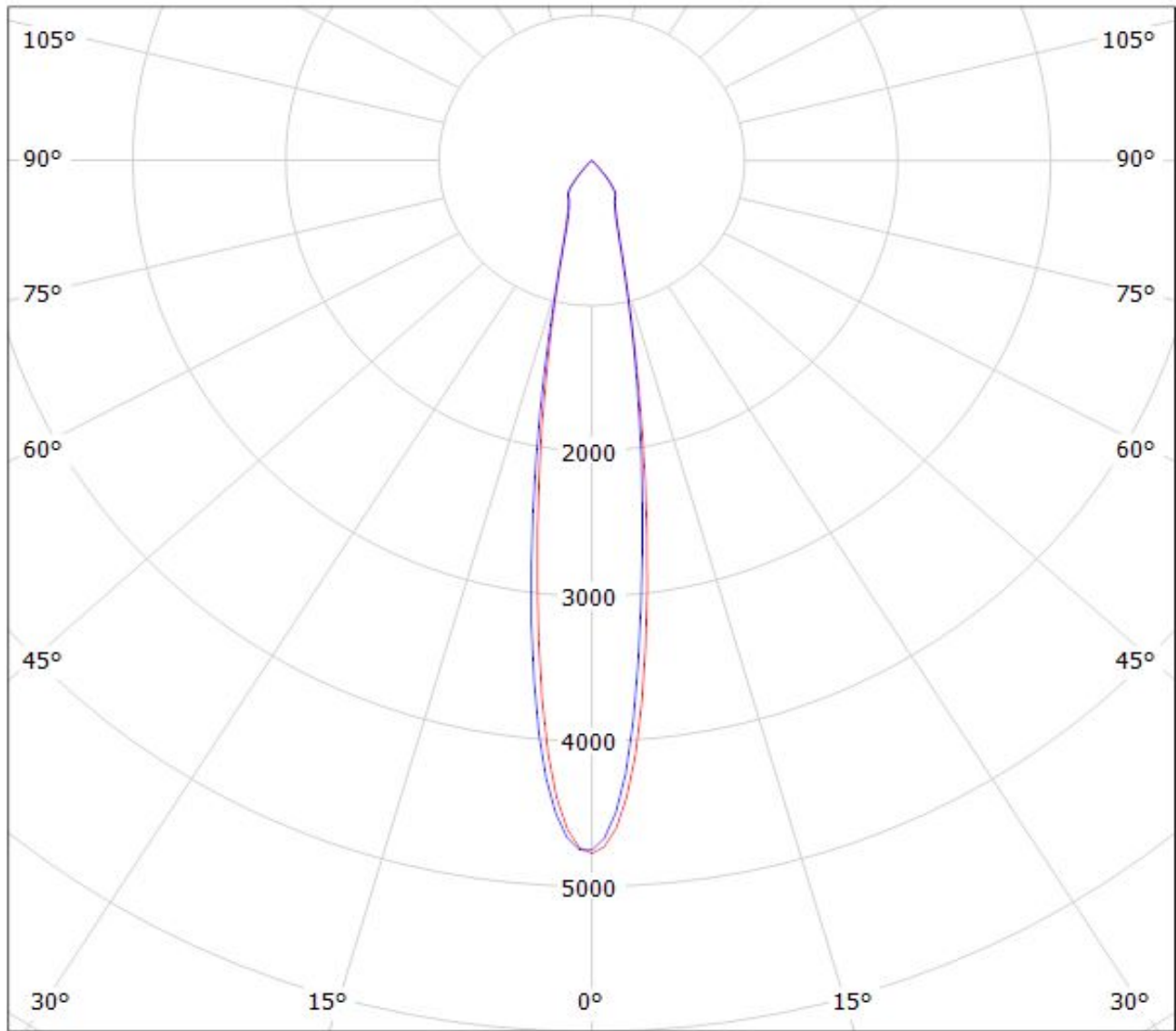

cd/klm

— C0 - C180

— C90 - C270

$\eta = 91\%$

Luminaire: LEDiL Oy CN13127_MIRELLA-50-S-PF_(SLE-G5_LES-6)_C13083_PF-SOCKET)
Lamps: 1 x Tridonic_SLE-G5_LES-6_468.743lm@100mA_P=3.3717W_I=0.100A

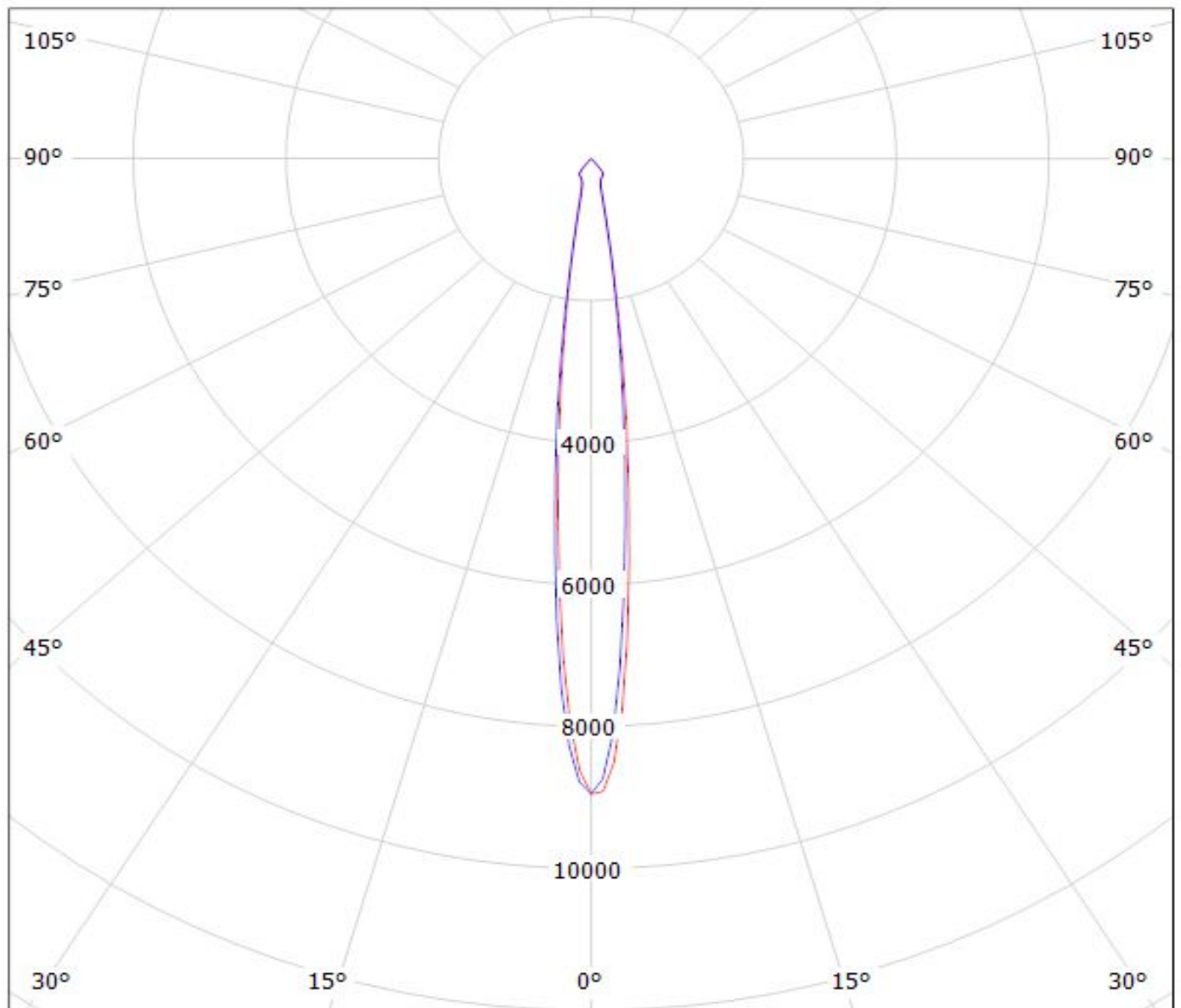

cd/klm

— C0 - C180

— C90 - C270

$\eta = 89\%$

Luminaire: LEDiL Oy CN13127_MIRELLA-50-S-PF_(SLE-G5_LES-11)

Lamps: 1 x Tridonic_SLE-G5_LES-11_1166.25lm@250mA_P=8.3218W_I=0.250A

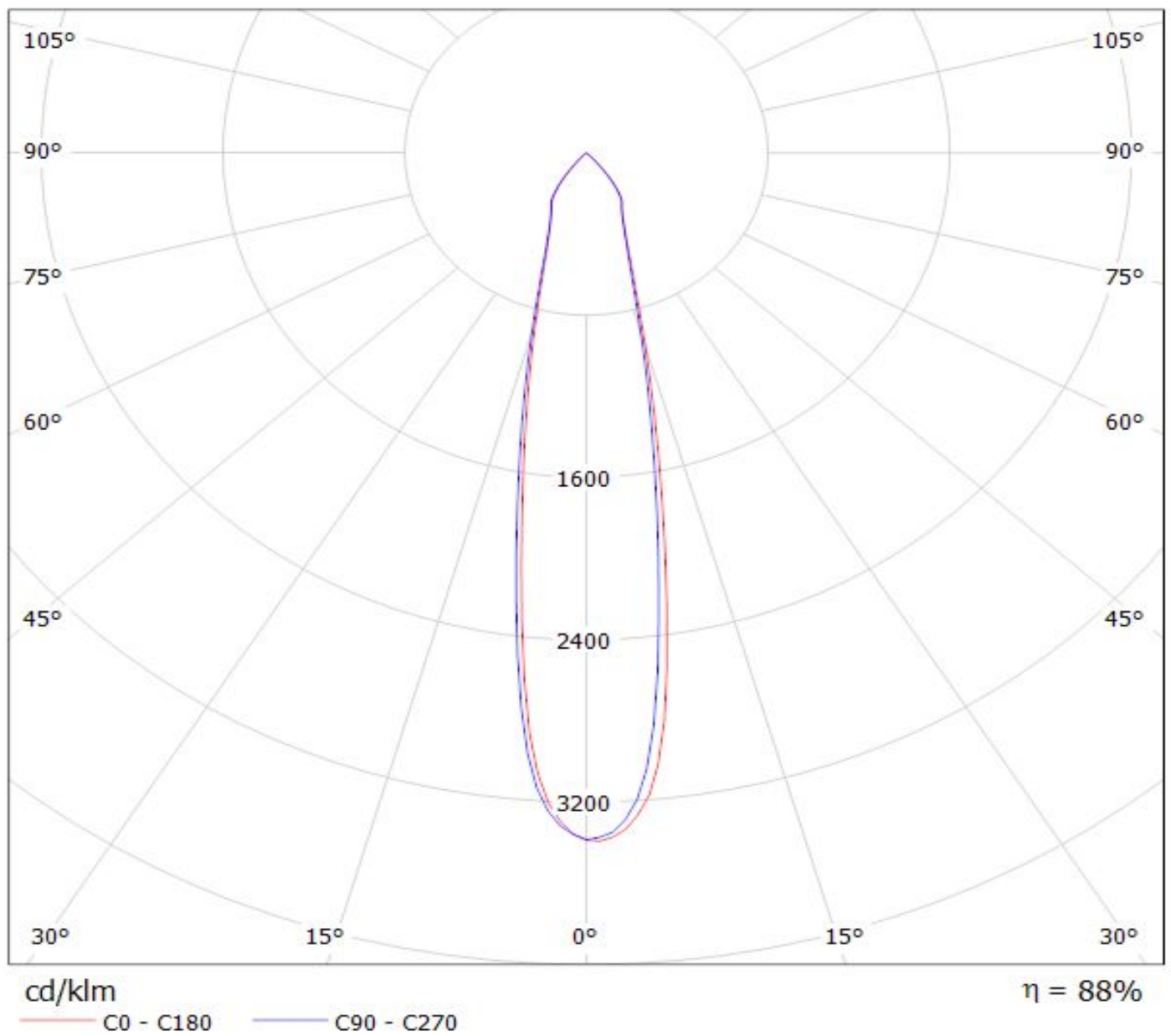

NOTE: The typical divergence will be changed by different color, chip size and chip position tolerance. The typical total divergence is the full angle measured where the luminous intensity is half of the peak value.

GENERAL INFORMATION

- Product series especially designed & optimized for series of LEDs.
- Special care taken to make light distribution as uniform as possible.

Note! Due to use of high power COB's with this product, special attention to proper thermal design is highly recommended. LEDiL has no liability for direct, indirect or consecutive damages arising from the LEDiL products being used outside of the recommended temperature range.