



Fakra Connector

Titan

AA.105.301621

Specification

Part No.	AA.105.301621
Product Name	Titan GPS Antenna AA.105 3M RG174 Fakra Code C Blue SMB(F)
Feature	Magnetic Mount Covert stylish design Wide band input voltage 28db Gain Gain is Customizable IP-67 Waterproof

1. Introduction

Our AA.105 Titan magnetic mount external antenna is ideal for robust, covert installations where durability and small size is paramount. It is used in telematics and M2M applications, for example in commercial vehicle installations for fleet management. It is fully waterproof to IP67 rating.

2. Electrical Specifications

Ceramic Patch Specification	
Outline Dimension	25*25*4mm
Ground Size	25*25*4mm
Center Frequency	1575.42±3MHz
Bandwidth	10MHz
VSWR	1.92 Max
Axial ratio	3dB Typ.
Gain @ Zenith	2dBi Typ.
Impedance	50Ω
Polarization	RHCP
LNA Specification	
Frequency	1575.42MHz
Impedance	50Ω
VSWR	1.92 Max.
Gain	30dB Typ.
Gain at Connector*	28.4dB
DC Power Input	2.7~5V
Noise Figure	1.5dB Typ.
Weight	75g
Power Consumption	4.7mA @2.7V
	6mA @3.3V
	10.3mA @5V
Operating temp	-40°C ~ +85°C
Storage Temp	-40°C ~ +90°C

*Formula = Patch Antenna Average Gain + LNA typical gain – RG174 cable loss @1.2dB per meter = Gain at connector
 Gain at the Connector - Patch Gain 2dB + LNA Gain 30dB – Cable loss of 1.2dB per metre (@3m = 3.6dB) = 28.4dB approx.

3. Ceramic Antenna S11 (With housing)

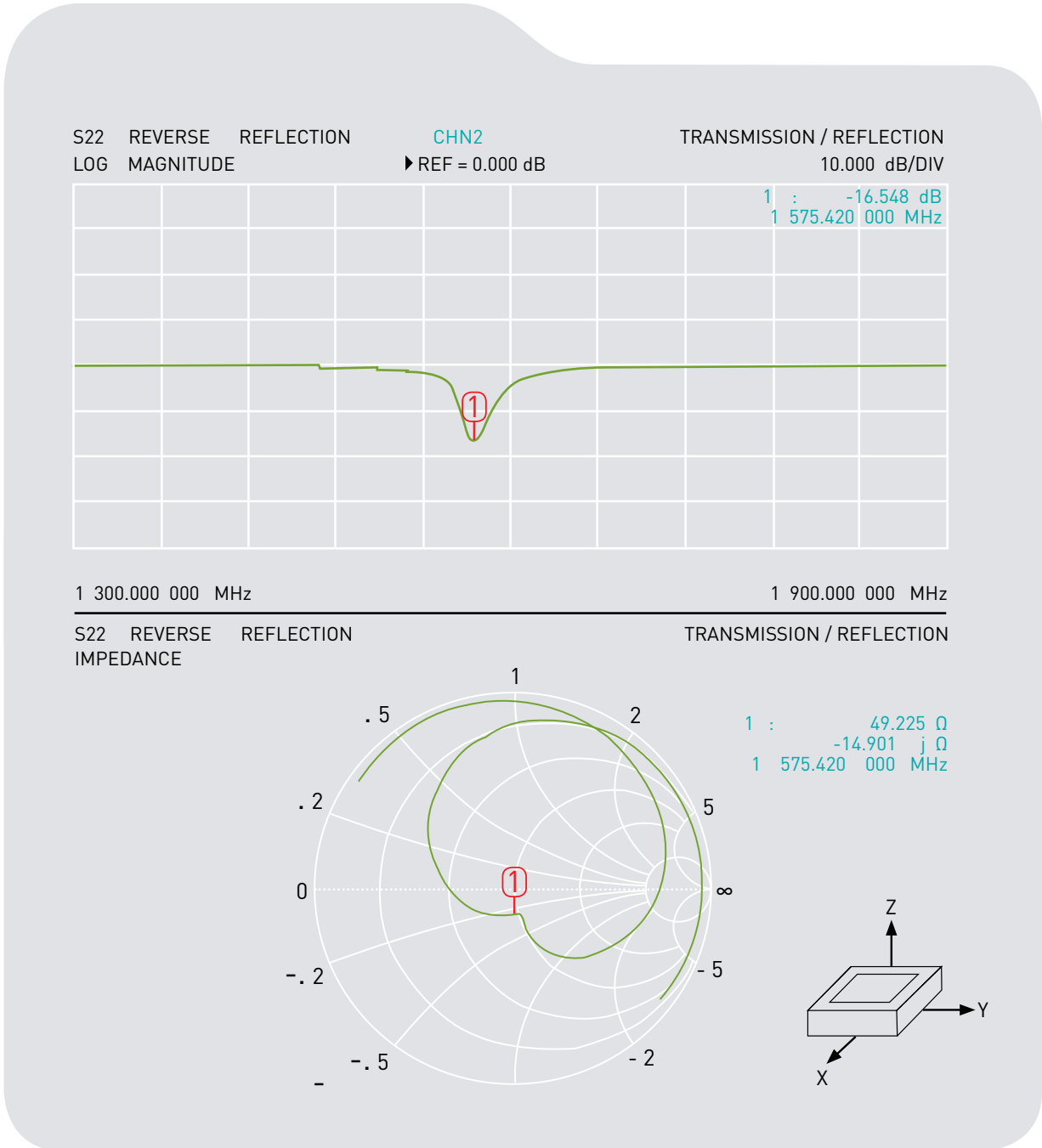

4. Ceramic Antenna Radiation Pattern (With housing)

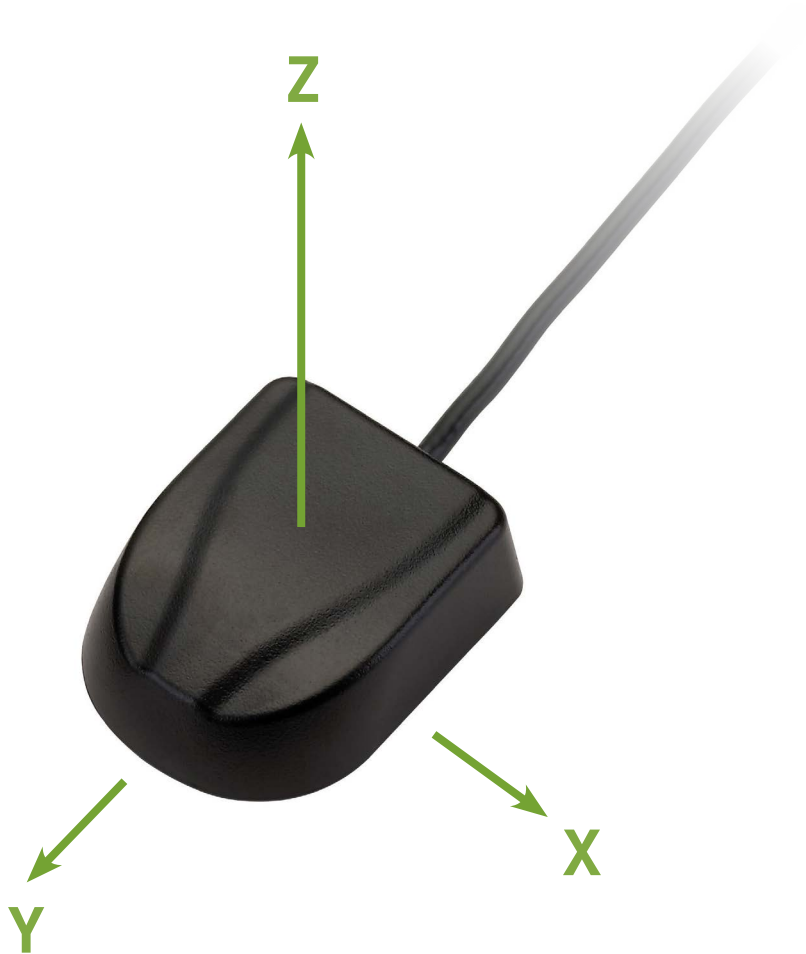

4.1 XZ Plane & YZ Plane

XZ Plane

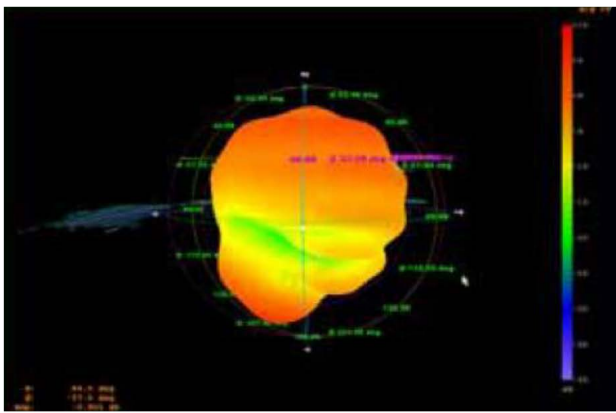

YZ Plane

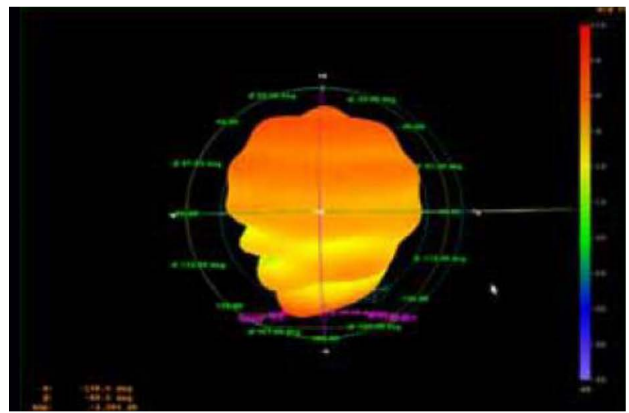

Far-field amplitude of goasial
1583 06-5-8.nsi

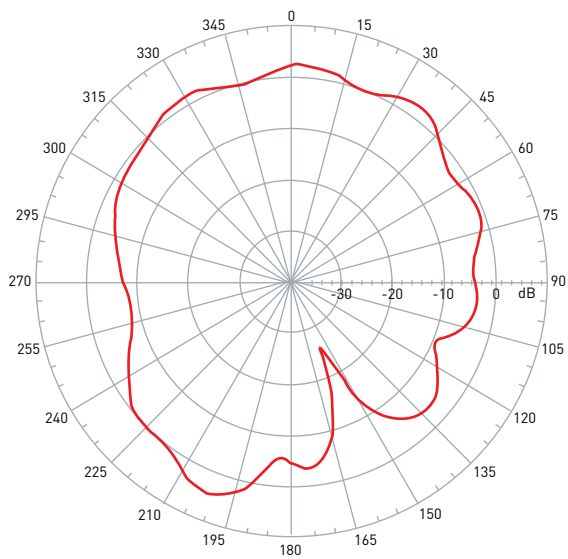

Far-field amplitude of goasial
1583 06-5-8.nsi

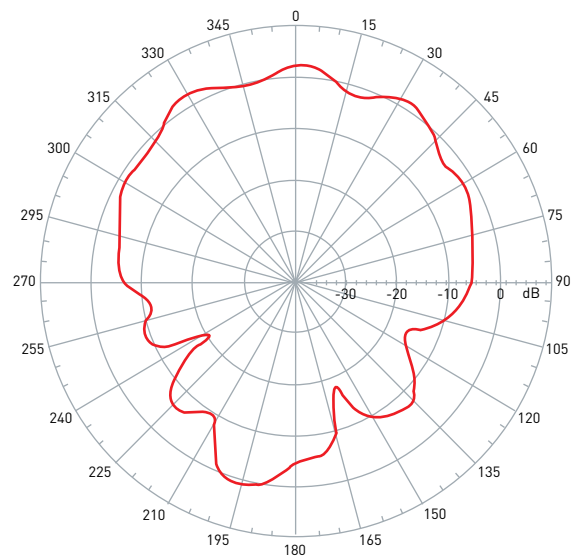

5. LNA gain

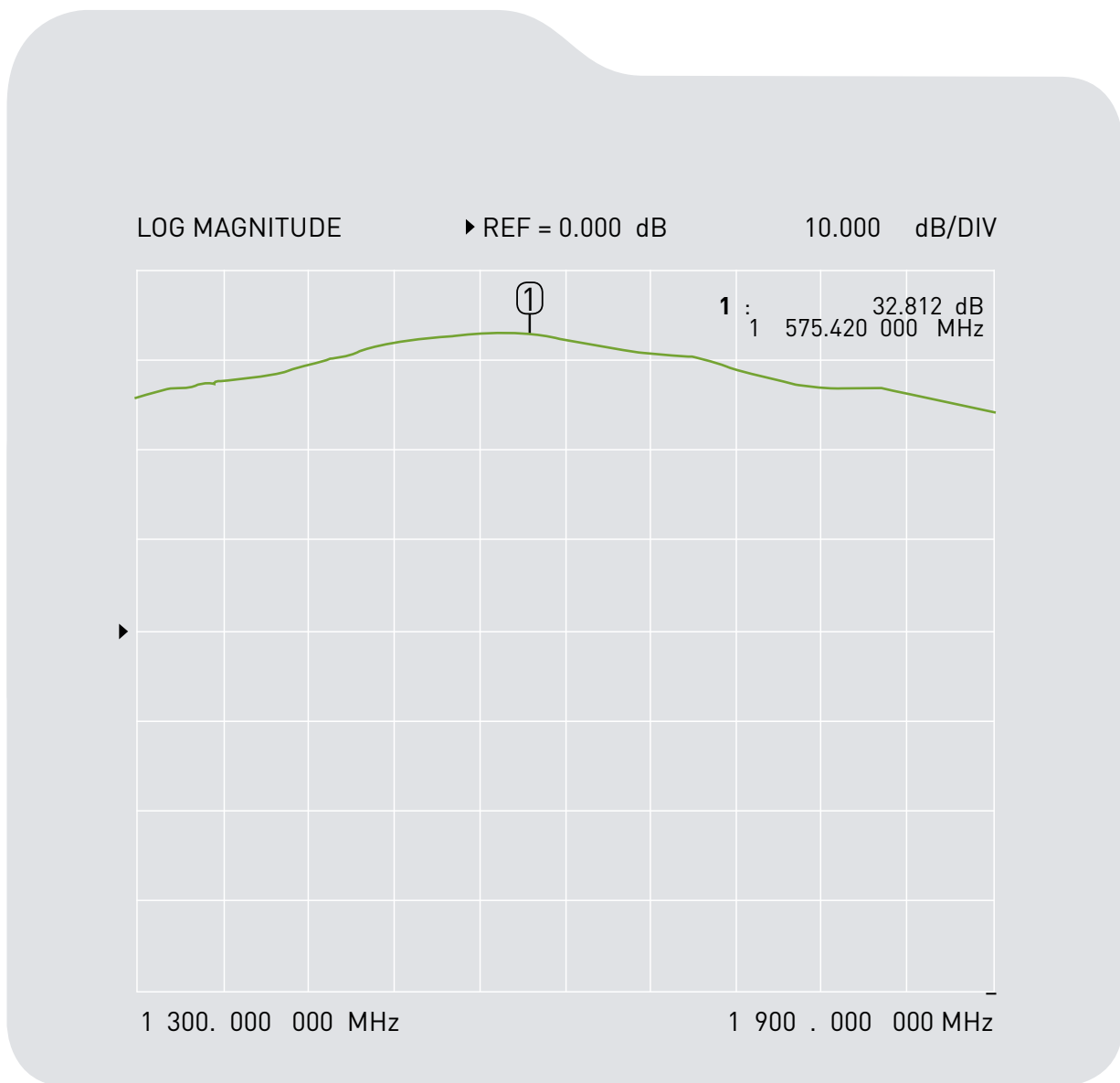

6. LNA S22

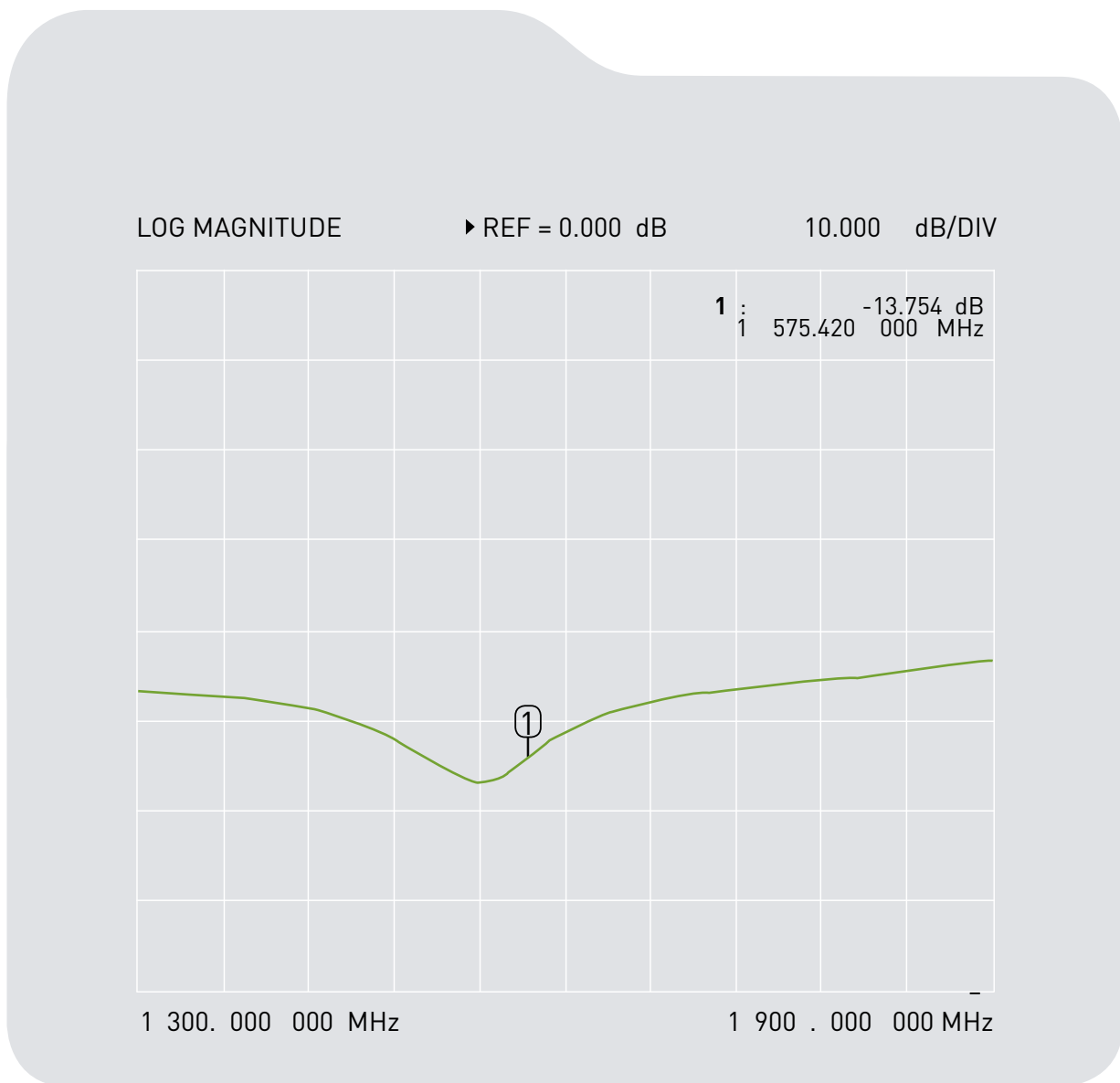

7. Drawing

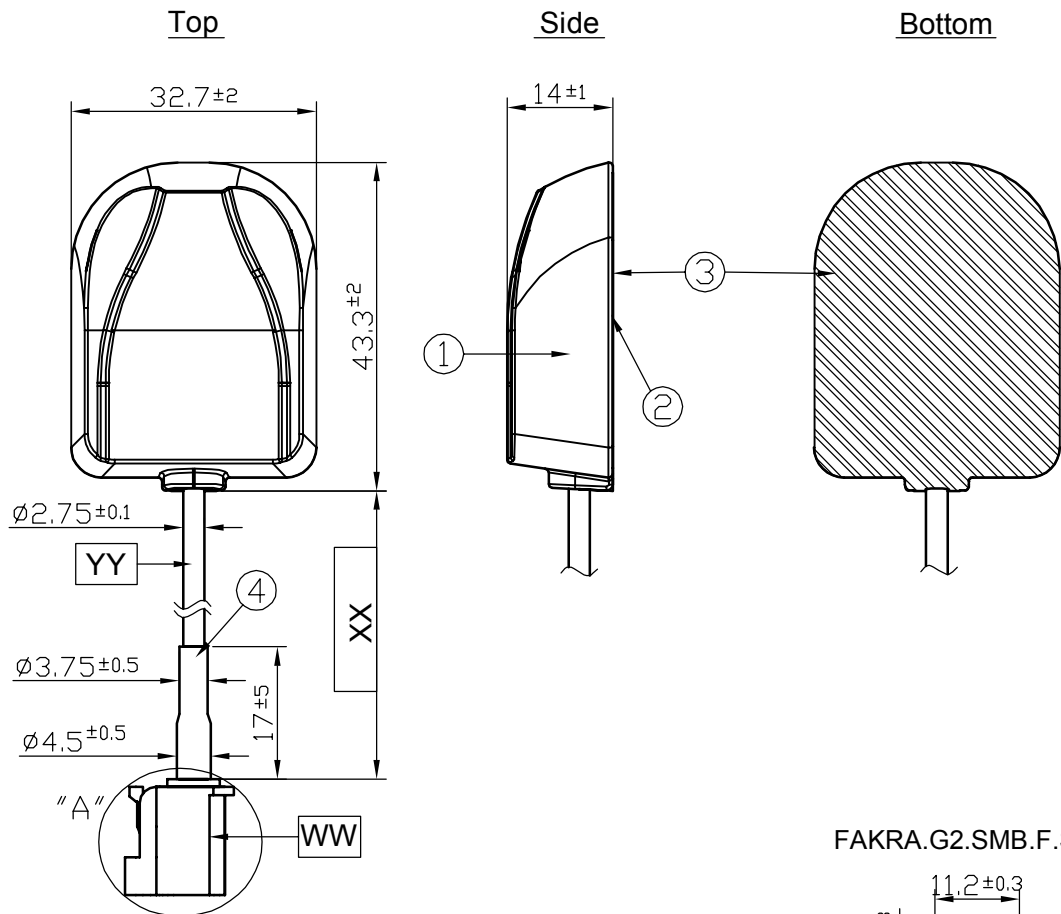

FAKRA.G2.SMB.F.ST.C.B.AM

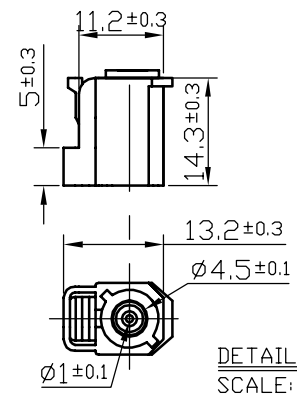

	Name	Material	Finish	QTY
1	GPS Antenna Housing Top	PC	Black	1
2	GPS Antenna Housing BottomP	C	Black	1
3	Sticker	Matte Silver PET	Silver	1
4	Heat Shrink Tube	PE	Black	1

	Name	Spec	Finish	QTY
WW	Connector Type	FAKRA Code C GEN2	Blue	1
XX	Cable Length	3000±30mm	Black	1
YY	Cable Type	RG174	Black	1

NOTES:

1. Sticker area. 

8. Packaging

1 AA.105.301621 per PE bag
Bag Dimensions - 220*107mm
Total Weight - 72g

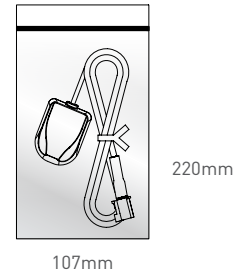

120 PE bags per large PE Bag
Large Bag Dimensions - 280*440mm
Weight - 9.1Kg

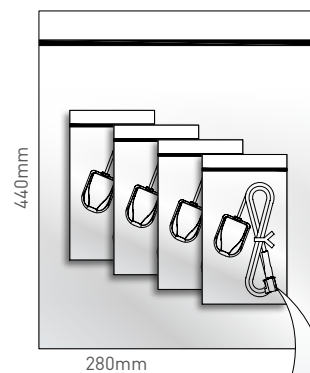

1 Large PE Bags per Outer Carton
Carton Dimensions - 400*340*220mm
Weight - 9.6Kg

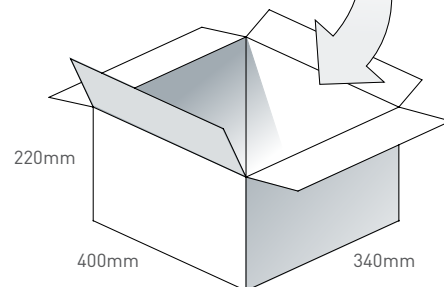

Pallet Dimensions 1100*1100*1500mm
48 Cartons per pallet
12 Cartons per layer
4 Layers

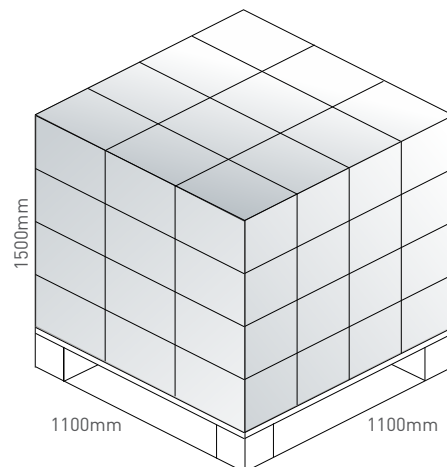

Taoglas makes no warranties based on the accuracy or completeness of the contents of this document and reserves the right to make changes to specifications and product descriptions at any time without

notice. Taoglas reserves all rights to this document and the information contained herein.

Reproduction, use or disclosure to third parties without express permission is strictly prohibited.

Copyright © Taoglas Ltd.