



2522 and 2523 Fiber Optic Splice Organizer Tray

Instructions

Table of Contents

- 1. General 2
- 2. Kit Contents 2
- 3. Available Kits and Accessories 3
- 4. Tray Dimensions and Capacities 4
- 5. Splice Preparation 5
- 6. FibrTube Installation 6
- 7. Fiber Organization and Splicing 9
- 8. Ribbon Installation 10
- 9. Tray Stacking 11
- 10. Reentry 12

1.0 General

1.1 The 3M™ 2522 and 2523 Fiber Optic Splice Organizer Trays protect, organize, and store a variety of splices. Each tray stores 250 micron, 900 micron, and all ribbon fiber sizes. A 3 in. (76.2 mm) minimum bend diameter is maintained in each tray. All four corners have features which can accommodate three 3M FibrTube transport tubes and one oversized buffer tube for a total of 16 tube entrances. The tray cover is made of a clear material for easily identifying the splices. Trays can be stacked via rubber retainers which also act as hinges.

2.0 Kit Contents

2.1 2522 Small Fiber Optic Splice Organizer Tray Kit

- a. Splice Tray
- b. Tray Cover
- c. Cable Ties (10)
- d. Tray Retainers (4)
- e. 3M FibrTube Transport Tubes - (3)

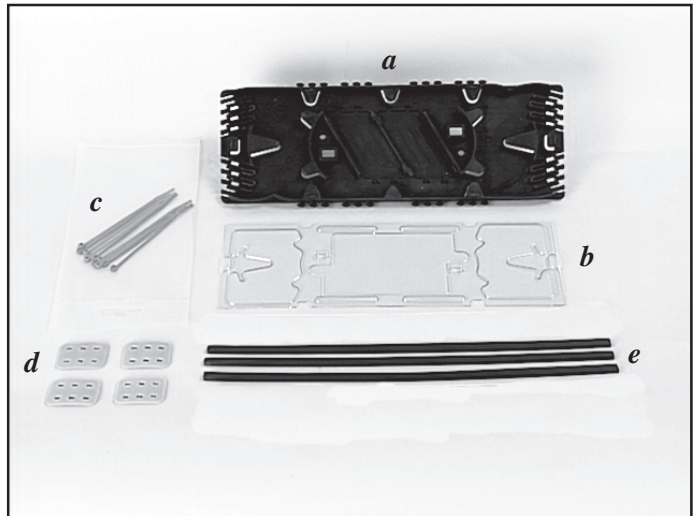

2.2 2523 Large Fiber Optic Splice Organizer Tray Kit

- a. Splice Tray
- b. Tray Cover
- c. Cable Ties (10)
- d. Tray Retainers (4)
- e. 3M FibrTube Transport Tubes - (4)

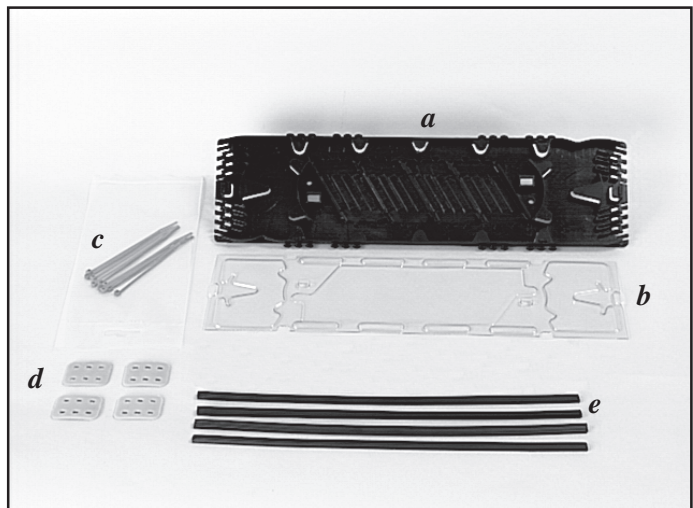

3.0 Available Kits and Accessories

3.1 Splice Inserts

3.1.1 Splice Insert Kits

- a. 3M™ 2521-FL Fibrlok™ Mechanical Splice Insert
- b. 3M™ 2521-F Single Fusion Splice Insert
- c. 3M™ 2521-MF Fibrlok™ Multi-Fiber Splice Insert
- d. 3M™ 2521-RF™ Ribbon Fusion Splice Insert
- e. Labels

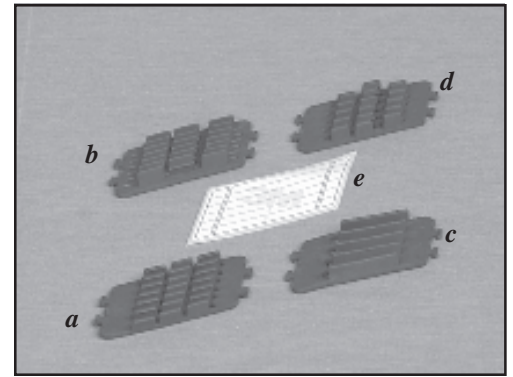

3.1.2 Splice Insert Capacities

Insert	Types of Connectors	Connectors per Insert
a. 3M 2521-FL Fibrlok™ Mechanical Splice Insert	3M™ Fibrlok™, Siecor CamSplice, Northern Telecom Lightbridge	6
b. 3M 2521-F Single Fusion Splice Insert	3M™ 2170 Splice Sleeve and most other manufacturer's fusion sleeves	12
c. 3M 2521-MF Fibrlok™ Multi-Fiber Splice Insert	3M™ MultiFiber Fibrlok™	4
d. 3M 2521-RF Ribbon Fusion Splice Insert	Most manufacturer's mass fusion sleeves	5

3.2 3M™ 2526 Hook and Loop Strap Kit

- a. Hook Material Strap
- b. Loop Material Tabs

Note: Refer to sections 9.3 and 9.4 for use.

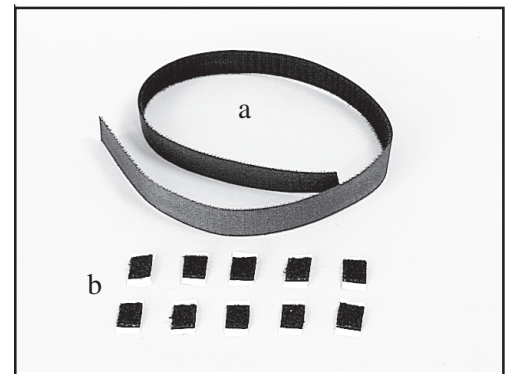

3.3 3M Compatible Closures and Capacities

Closure	Number of Trays
2178-S	2
2178	5
2178 plus one 2181	8
2178 plus two 2181	11

4.0 Tray Dimensions and Capacities

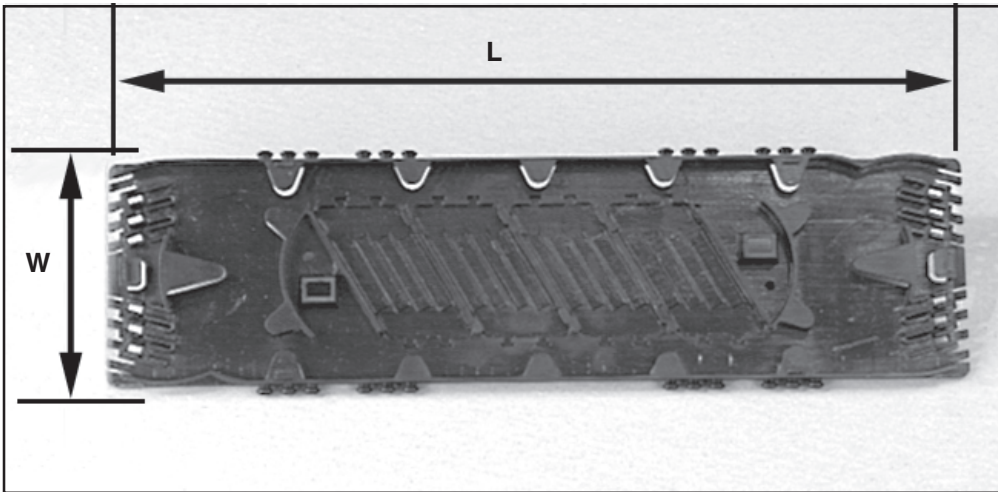

4.1 Fiber Optic Organizer Tray Dimensions

	2522 Tray	2523 Tray
Width (W)	4.3 in. (10.9 cm)	4.3 in. (10.9 cm)
Length (L)	11.5 in. (29.2 cm)	14.9 in. (38.9 cm)
Tray Height	0.65 in. (1.64 cm)	0.65 in. (1.64 cm)
Stack Height (2 trays)	1.23 in. (3.12 cm)	1.23 in. (3.12 cm)

Note: Each additional tray adds 0.58 in (1.48 cm) to the total stack height.

4.2 Fiber Optic Organizer Tray Splice Capacities

	2522 Tray	2523 Tray
Number of Inserts	2	4
Maximum Number of Single Mechanical Splices per Tray	12	24
Maximum Number of Single Fusion Splices per Tray	24	48
Maximum Number of Mass Mechanical Splices per Tray	8 (96 fibers)	12* (144 fibers)
Maximum Number of Mass Fusion Splices per Tray	10 (120 fibers)	12* (144 fibers)

* The number of mass mechanical and fusion splices in the 3M™ 2523 tray is limited by the space required for the ribbon fiber.

5.0 Splice Preparation

5.1 Cable Preparation

Danger! *Fiber ends and unmated connectors may emit INVISIBLE laser or LED radiation. Avoid direct eye exposure to the beam. Do not inspect with magnifying instruments. Cap plugs should be kept on all unmated connectors.*

5.1.1 Remove the appropriate amount of sheath per the closure manufacturer's practice.

5.1.2 Clean the sealant from the buffer tube(s) per the cable manufacturer's practice.

Note: *Carefully follow health and safety information given on cleaning solvent container label or Material Safety Data Sheet.*

5.1.3 Expose at least 4 ft. (1.22 m) of bare fiber. Make sure the buffer tubes are cut 6 in. (15.2 cm) or less from the tray end where the fibers will enter.

5.1.4 Clean the bare fibers per the cable manufacturer's practice.

Note: *Carefully follow health and safety information given on cleaning solvent container label or Material Safety Data Sheet.*

5.2 Tray Preparation

5.2.1 Install the proper splice inserts into the splice organizer tray. Splice inserts are ordered separately (see section 3, "Available Kits and Accessories.")

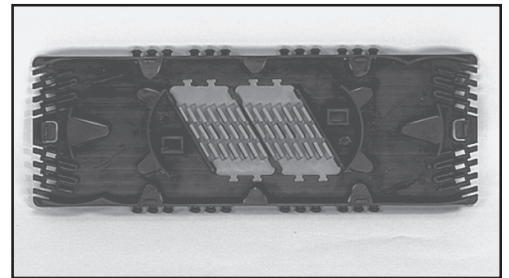

5.2.2 Apply the label to the splice tray cover. Labels are supplied with the splice insert kits (refer to section 3.1.1).

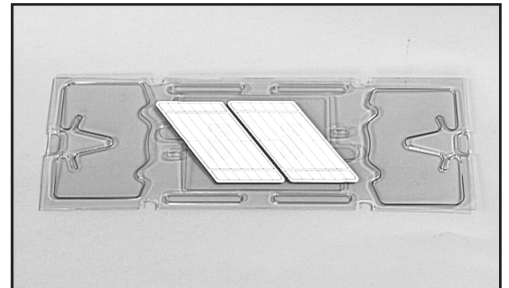

5.2.3 Install the splice tray in the closure. The tray has two holes which accommodate #8-32 screws, and a flat surface on the bottom for adhesive type fasteners. The method for fastening the tray is usually supplied with the closure.

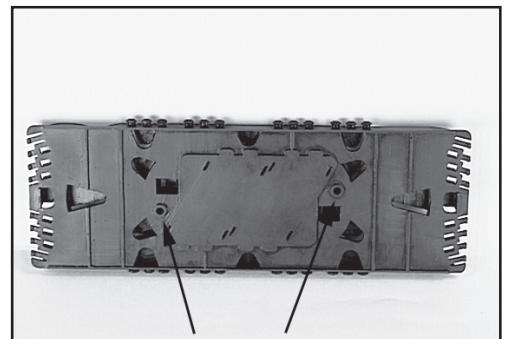

6.0 FibrTube Installation

Note: The following procedure is shown with the 3M™ 2178 Fiber Optic Splice Closure. Certain steps may vary with other closures.

6.1 The 3M™ FibrTube will hold a maximum number of fibers (or ribbons) as shown in table to the right. A fan-out or breakout kit may be necessary to transition the bundle to the appropriate number of fibers (or ribbons).

<i>Fiber Type</i>	<i>Maximum per FibrTube</i>
250 micron	36 fibers
900 micron	6 fibers
Ribbon	4 Ribbons

6.2 Determine the routing of the fiber from the buffer tube storage area to the tray. Position a piece of FibrTube over the intended route. Make sure the bend radius is not less than the minimum bend radius of the fibers.

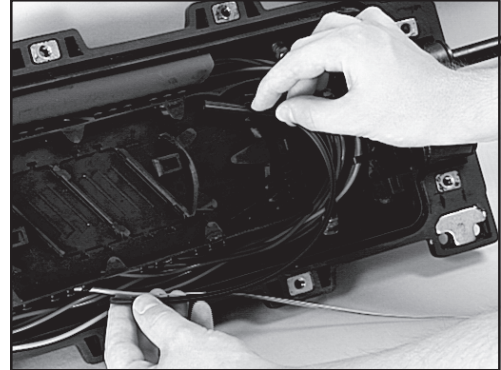

6.3 Orient the FibrTube with the two ridges facing up.

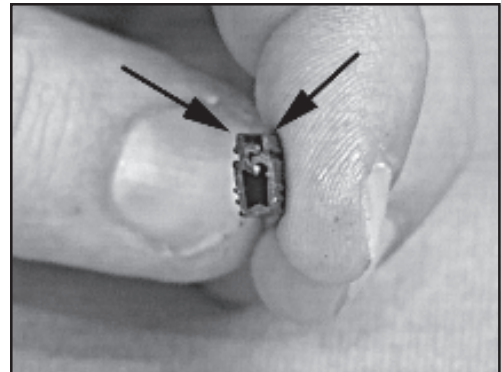

6.4 Allow for a 1 in. (2.5 cm) overlap between the FibrTube and the buffer tube.

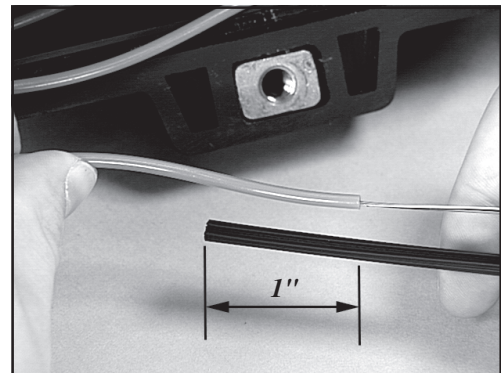

- 6.5 Snap the 3M™ FibrTube into the intended splice tray entrance location. Cut the FibrTube near the end of the retainer slot.

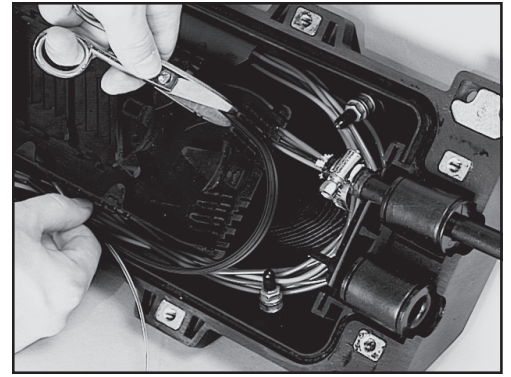

- 6.6 Remove the FibrTube and unzip it by grasping and separating the two upper ridges.

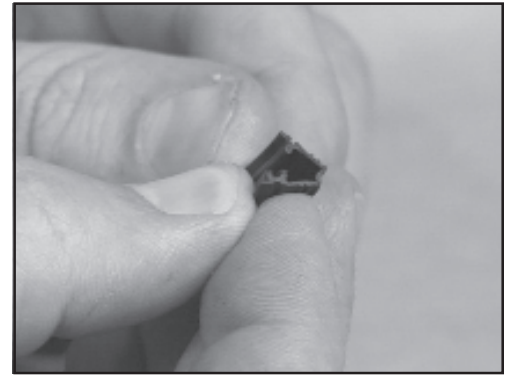

- 6.7 Install the fibers into the FibrTube.

Tip: *Use a short section of buffer tube or FibrTube as an installation tool. Start at one end of the FibrTube and run the fibers along the channel, re-zipping once the fibers are in position.*

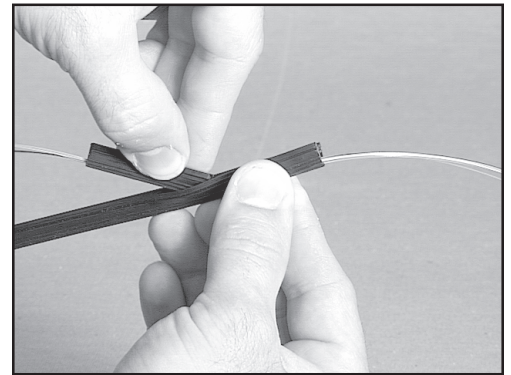

- 6.8 Ensure the FibrTube runs freely over the fibers. If necessary, unzip the tubing and repeat the process in step 6.7. Remove the installation tool.

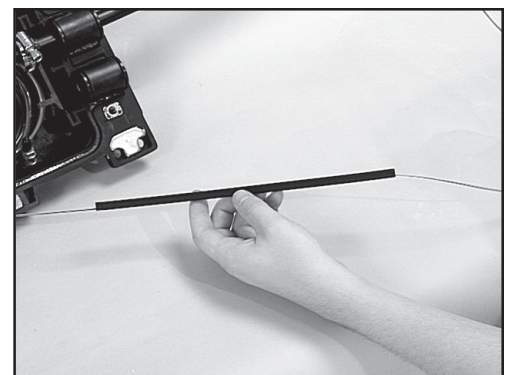

- 6.9 Place the 3M™ FibrTube over the buffer tube with a 1 in. (2.5 cm) overlap. Use a cable tie and/or vinyl tape to secure the FibrTube to the buffer tube.

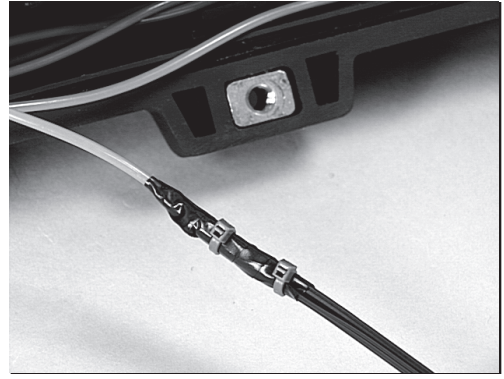

- 6.10 Install the FibrTube in the organizer tray by pressing the tube in the channel with the two ridges facing up. The end of the FibrTube should not extend into the fiber routing area of the tray.

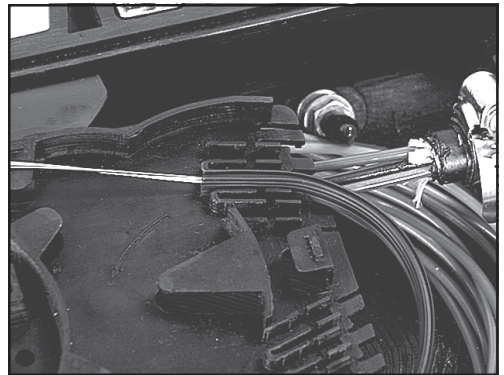

Tip: *Route the FibrTubes into the trays so that the trays can be hinged or removed for future access.*

- 6.11 Secure the FibrTube with a cable tie.

Tip: *Loop a cable tie around the FibrTube but don't tighten. Slide the looped cable tie down the grooves in the end of the organizer tray. Finish tightening the cable tie.*

Do not over tighten the cable tie. Over tightening could crush and damage the fibers.

- 6.12 Repeat steps 6.2 through 6.11 for the remaining buffer tubes which will be routed to the same tray.

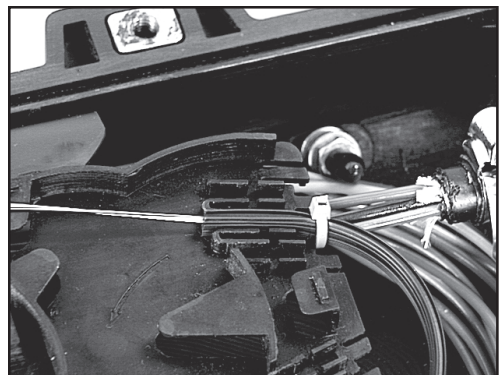
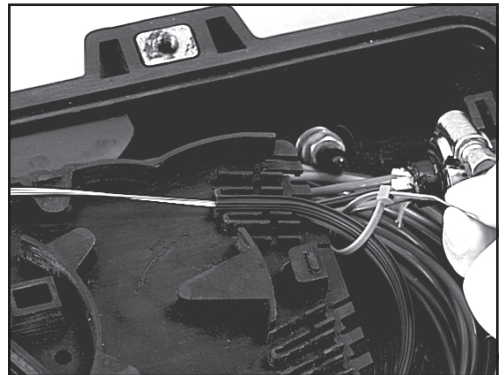

7.0 Fiber Organization and Splicing

Danger! *Fiber ends and unmated connectors may emit INVISIBLE laser or LED radiation. Avoid direct eye exposure to the beam. Do not inspect with magnifying instruments. Cap plugs should be kept on all unmated connectors.*

- 7.1 Locate a group of fibers which will be spliced in one insert (see section 3.1.2 for individual insert capacity). Wrap the fibers around the tray following the direction of the arrows molded in the tray base. Make at least one complete circle. Position the fiber bundle midway between the curved walls.

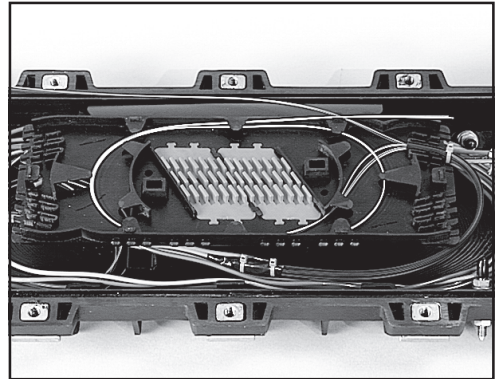

- 7.2 Lay the fibers in the middle slot of the appropriate insert. Trim the fibers leaving sufficient length for stripping and cleaving.

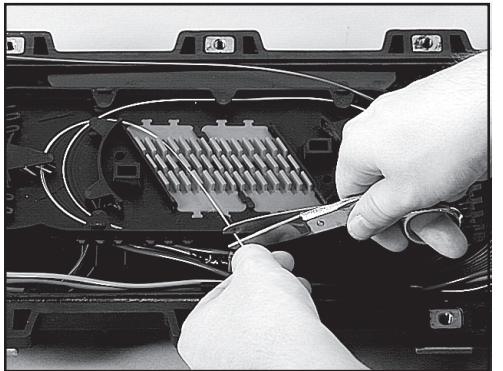

- 7.3 Repeat steps 7.1 and 7.2 for the group of fibers which will be spliced to the first group of fibers.

- 7.4 Strip, cleave, and splice the first pair of fibers. Place the spliced connector in the insert. Repeat the process until the insert is full.

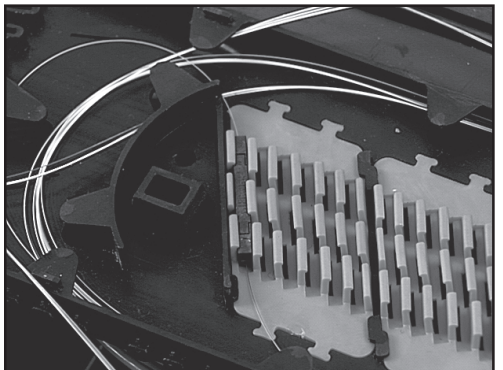

- 7.5 Repeat steps 7.1 through 7.4 until the tray has reached its capacity (see section 4.2 for splice tray capacities).

- 7.6 The label on the top of the tray cover allows for the identification of splices and/or fiber count. For ease of use, remove the cover when writing.

- 7.7 Place the cover on the organizer tray by bending the cover upward and sliding the ends under the tabs near the tray ends. Press lightly on the cover to lock it into place.

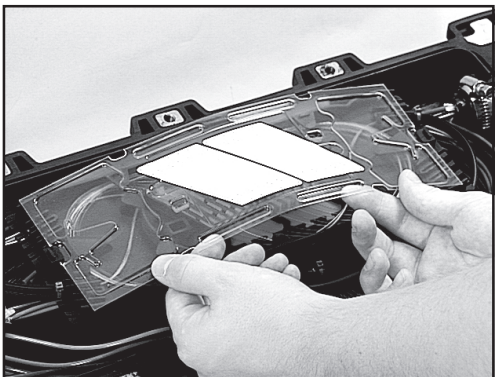

8.0 Ribbon Installation

- 8.1 Install the tray support in closure and place trays in the appropriate place by moving them as far as possible toward one end of closure.

Note: *When working with high fiber count cable, the 2178-STS, Splice Tray Support should be used where additional splice trays are being added to a closure and at least one 2181 Cable Addition Kit is used. This would replace the 2178-LTS Splice Tray Support that is shipped with the 2178 LS-FR in this application only.*

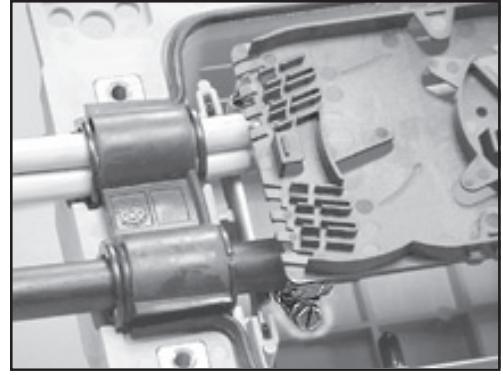

- 8.2 Attach the first tray to the bridge by using the 4 pieces of material supplied with the first closure.
- 8.3 Install the ribbon into each tray, using short pieces of the black transport tube that is furnished with each tray. A maximum of 4 ribbons may be put into each transport tube.

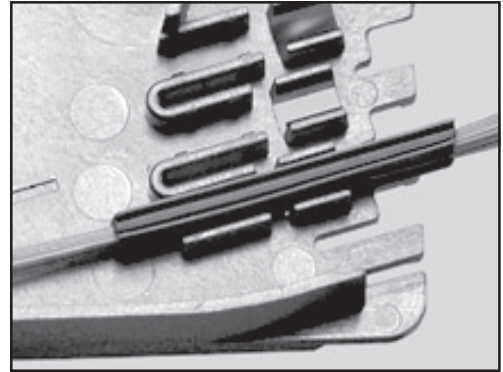

- 8.4 Route the ribbons into the tray in the configuration shown.

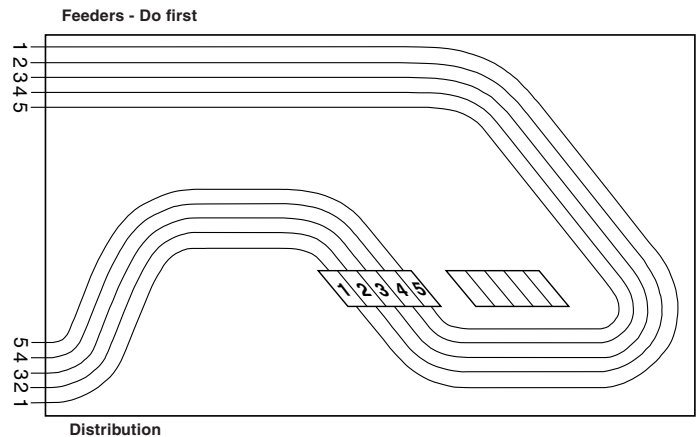

- 8.5 Trim each ribbon as it is spliced. Make sure you leave enough length to make up for stripping and cleaving.

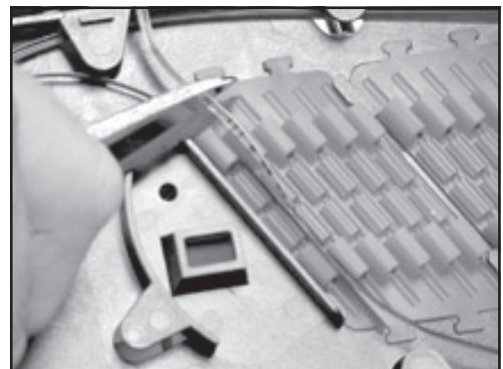

9.0 Tray Stacking

- 9.1 Press all four rubber retainers onto the knobs on the outside of the organizer tray.

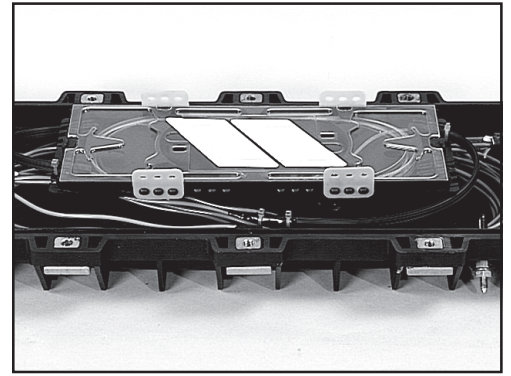

- 9.2 Position another tray on top of the first one. Make sure each set of knobs lines up with the ones below. The trays should be nested.

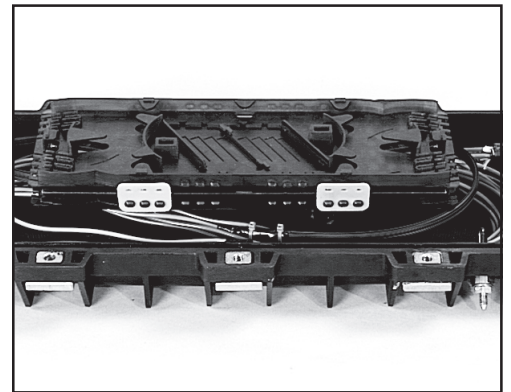

- 9.3 Press the free ends of the rubber retainers onto the unsecured tray.

- 9.4 Repeat sections 6 and 7 for each newly attached organizer tray.

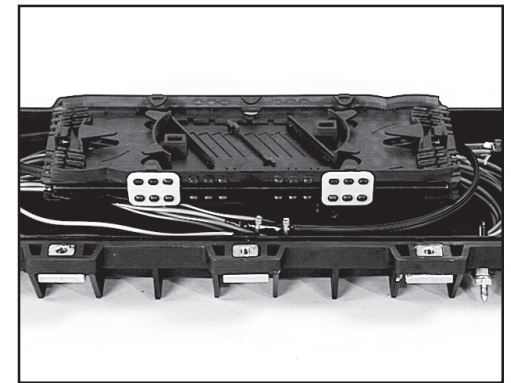

- 9.5 Stack additional trays by using the inside set of knobs and repeat steps 8.1 through 8.3.

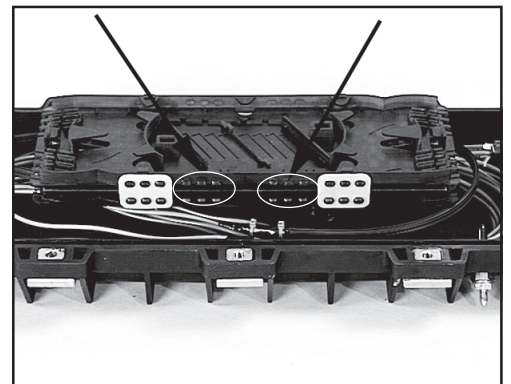

10.0 Re-entry

10.1 Detach two rubber retainers from one side of the organizer tray above the tray which will be re-entered. The retainers on the other side of the trays will act as a hinge. Detach all four retainers to completely remove the top tray.

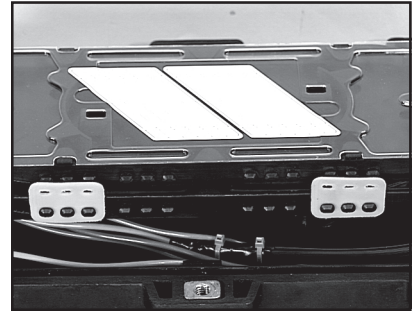

10.2 Expose the desired organizer and remove the cover by lifting from the edges between the press-fit features.

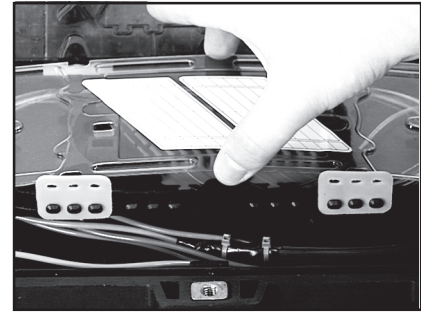

Note: *The 3M™ 2526 Hook and Loop Strap Kit is needed for the next two steps. See section 3.2.*

10.3 Remove the backing from the hook tabs. Attach the tabs to the sides of the trays.

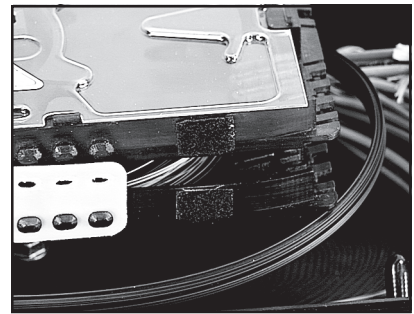

10.4 Attach the loop strap to the hook tab on the exposed organizer tray. Wrap the strap around the back of the stacked trays. Attach the strap to the trays above the exposed tray to hold the trays in an open position.

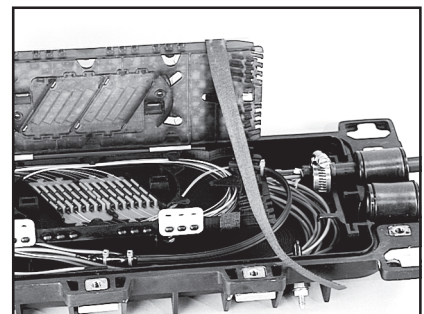

Important Notice

Before using this product, you must evaluate it and determine if it is suitable for your intended application. You assume all risks and liability associated with such use.

Warranty; Limited Remedy; Limited Liability. This product will be free from defects in material and manufacture as of the date of purchase. **3M MAKES NO OTHER WARRANTIES INCLUDING, BUT NOT LIMITED TO, ANY IMPLIED WARRANTY OF MERCHANTABILITY OR FITNESS FOR A PARTICULAR PURPOSE.** If this product is defective within the warranty period stated above, your exclusive remedy shall be, at 3M's option, to replace or repair the 3M product or refund the purchase price of the 3M product. **Except where prohibited by law, 3M will not be liable for any loss or damage arising from this 3M product, whether direct, indirect, special, incidental or consequential regardless of the legal theory asserted.**



Telecom Systems Division

6801 River Place Blvd.
Austin, TX 78726-9000
800/426-8688
www.3M.com/telecom



Printed on 50% recycled paper
with 10% post-consumer

Litho in USA.
© 3M IPC 2000 78-8130-2997-8-A