



Features:

- 2xMiMo 698-960/1710-2690MHz
- WiFi 2400-2500/4900-5900MHz
- Active GNSS:
 - GPS, Galileo, Glonass, Beidou
 - LNA Gain 30dB
- Size 145x135x25mm
- Adhesive mount on plastic and glass fiber surfaces
- Mounting accessory for metallic surfaces

Applications:

- Vehicle mount multiband antenna
- High Speed LTE data and WiFi
- Tracking, Navigation
- Fleet management
- Utility Vans (Gas, Water, Electricity)

All dimensions are in mm / inches

Issue: 1720

In the effort to improve our products, we reserve the right to make changes judged to be necessary.

CONFIDENTIAL AND PROPRIETARY INFORMATION

This document contains confidential and proprietary information of Pulse Electronics, Inc. (Pulse) and is protected by copyright, trade secret and other state and federal laws. Its receipt or possession does not convey any rights to reproduce, disclose its contents, or to manufacture, use or sell anything it may describe. Reproduction, disclosure or use without specific written authorization of Pulse is strictly forbidden.

For more information:

Pulse Worldwide Headquarters
15255 Innovation Drive #100
San Diego, CA 92128
USA
Tel: 1-858-674-8100

Pulse/Larsen Antennas
18110 SE 34th St Bldg 2 Suite 250
Vancouver, WA 98683
USA
Tel: 1-360-944-7551

Europe Headquarters
Pulse GmbH & Do, KG
Zeppelinstrasse 15
Herrenberg, Germany
Tel: 49 7032 7806 0

Pulse (Suzhou) Wireless Products Co, Inc.
99 Huo Ju Road(#29 Bldg,4th Phase
Suzhou New District
Jiangsu Province, Suzhou 215009 PR China
Tel: 86 512 6807 9998



Series: Jaguar

Description: 2xLTE, WiFi, GNSS Multiband
Vehicular Antenna

PART NUMBER: GPSPMB401

ELECTRICAL SPECIFICATIONS

LTE

Frequency	698-960/1710-2690	MHz
Nominal Impedance	50	Ω
VSWR	2.2	Max
Average Efficiency(698-960MHz)	72	%
Average Efficiency(1710-2690MHz)	68	%
Peak Gain (698-960MHz)	4.4	dBi
Peak Gain (1710-2690MHz)	5.4	dBi

WIFI

Frequency	2400-2500/4900-5900	MHz
Nominal Impedance	50	Ω
VSWR @2400-2500MHz	4	Max
VSWR @4900-5900MHz	3	Max
Average Efficiency(2400-2500MHz)	46	%
Average Efficiency(4900-5900MHz)	64	%
Peak Gain (2400-2500MHz)	4.5	dBi
Peak Gain (4900-5900MHz)	6.7	dBi

Issue: 1720

In the effort to improve our products, we reserve the right to make changes judged to be necessary.

CONFIDENTIAL AND PROPRIETARY INFORMATION

This document contains confidential and proprietary information of Pulse Electronics, Inc. (Pulse) and is protected by copyright, trade secret and other state and federal laws. Its receipt or possession does not convey any rights to reproduce, disclose its contents, or to manufacture, use or sell anything it may describe. Reproduction, disclosure or use without specific written authorization of Pulse is strictly forbidden.

Description: 2xLTE, WiFi, GNSS Multiband
Vehicular Antenna

Series: Jaguar

PART NUMBER: GPSPMB401

ELECTRICAL SPECIFICATIONS

GPS

Frequency 1561.098±2.046/ 1575.42±1.023/ 1602.5625±4 MHz

Nominal Impedance 50 Ω

VSWR 2:1

Gain (Radiating element) 1 dBic +/- 1 dB

Gain (LNA gain) 30 dB +/- 2 dB

Polarization RHCP

Out of Band Rejection

698 MHz >70 dB

960MHz >65 dB

1710MHz >60 dB

2170MHz >65 dB

2400MHz >65 dB

Noise Figure <2.4 dB

Operating Voltage 3.3-5 Vdc±0.5V

Current Consumption <11 mA

Description: 2xLTE, WiFi, GNSS Multiband
Vehicular Antenna

Series: Jaguar

PART NUMBER: GPSLPMB401

ELECTRICAL SPECIFICATIONS

Cable and Connector type

Item	GPSLPMB403 RF Cables	Cable Type	Cable Length	Connector
1	LTE-1	LMR195	3 meters [118.11"]	SMA Male
2	WiFi	LMR195		RP-SMA Male
3	GPS	LMR100		SMA Male
4	LTE-2	LMR195		SMA Male

Series: Jaguar

Description: 2xLTE, WiFi, GNSS Multiband
Vehicular Antenna

PART NUMBER: GPSPMB401

MECHANICAL SPECIFICATIONS

Plastic radome	SABIC PC943
Color	Black
Ingress Protection	IP67
Weight	400 g
Cable retention: Pull off	30N mini
Fixing system	3M VHB4959 (T=3mm)

ENVIRONMENTAL SPECIFICATIONS

Operating temperature	-40 ~ +85 ° C
-----------------------	---------------

Issue: 1720

In the effort to improve our products, we reserve the right to make changes judged to be necessary.

CONFIDENTIAL AND PROPRIETARY INFORMATION

This document contains confidential and proprietary information of Pulse Electronics, Inc. (Pulse) and is protected by copyright, trade secret and other state and federal laws. Its receipt or possession does not convey any rights to reproduce, disclose its contents, or to manufacture, use or sell anything it may describe. Reproduction, disclosure or use without specific written authorization of Pulse is strictly forbidden.

Description: 2xLTE, WiFi, GNSS Multiband
Vehicular Antenna

Series: Jaguar

PART NUMBER: GPSPMB401

MECHANICAL DRAWING

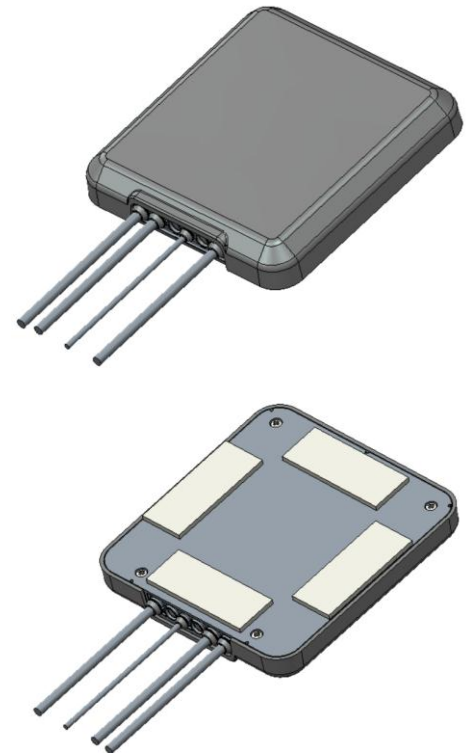
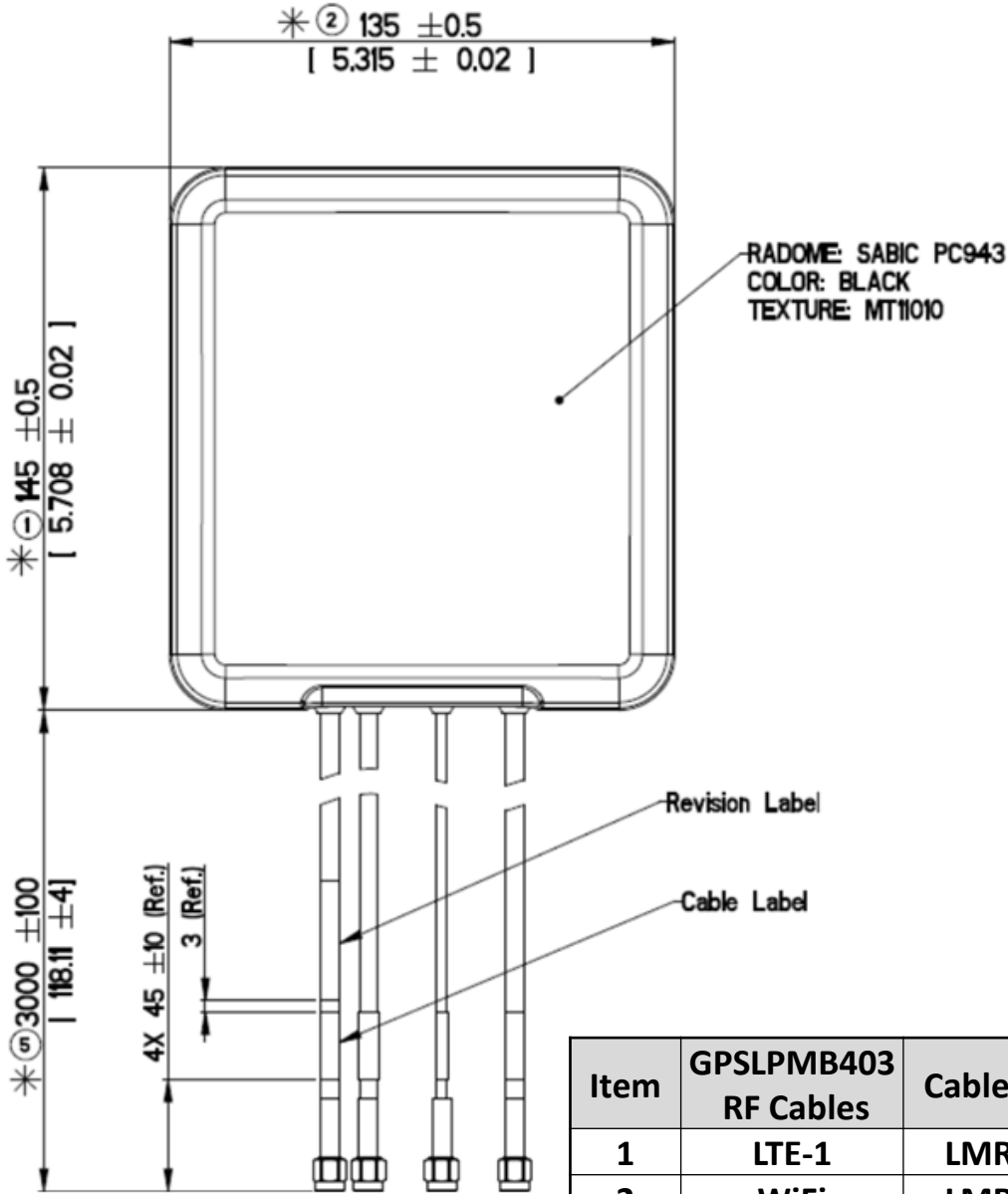

Item	GPSPMB403 RF Cables	Cable Type	Cable Length	Connector
1	LTE-1	LMR195	3 meters [118.11"]	SMA Male
2	WiFi	LMR195		RP-SMA Male
3	GPS	LMR100		SMA Male
4	LTE-2	LMR195		SMA Male

Issue: 1720

In the effort to improve our products, we reserve the right to make changes judged to be necessary.

CONFIDENTIAL AND PROPRIETARY INFORMATION

This document contains confidential and proprietary information of Pulse Electronics, Inc. (Pulse) and is protected by copyright, trade secret and other state and federal laws. Its receipt or possession does not convey any rights to reproduce, disclose its contents, or to manufacture, use or sell anything it may describe. Reproduction, disclosure or use without specific written authorization of Pulse is strictly forbidden.

Description: 2xLTE, WiFi, GNSS Multiband
Vehicular Antenna

Series: Jaguar

PART NUMBER: GPSPMB401

MECHANICAL DRAWING

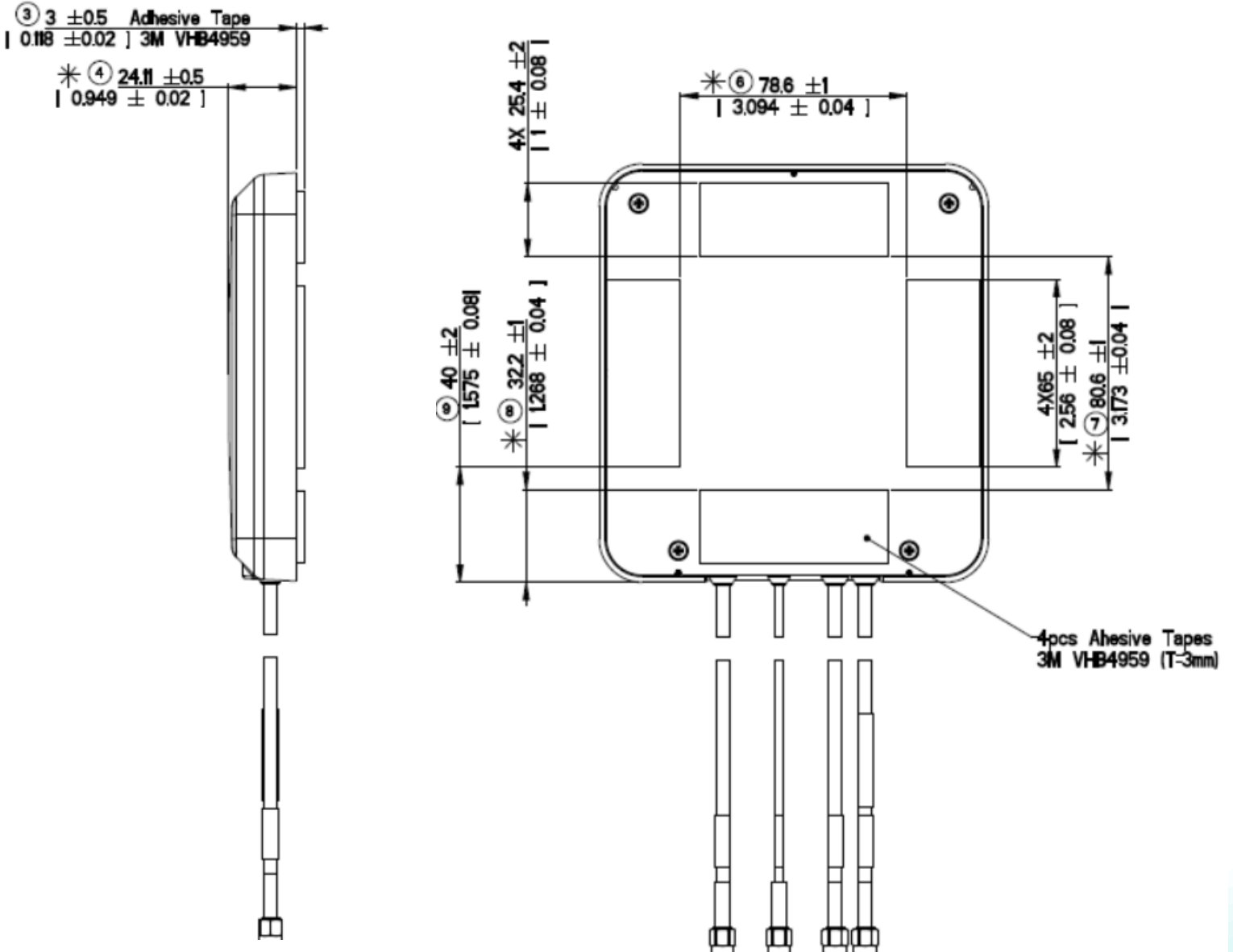

Issue: 1720

In the effort to improve our products, we reserve the right to make changes judged to be necessary.

CONFIDENTIAL AND PROPRIETARY INFORMATION

This document contains confidential and proprietary information of Pulse Electronics, Inc. (Pulse) and is protected by copyright, trade secret and other state and federal laws. Its receipt or possession does not convey any rights to reproduce, disclose its contents, or to manufacture, use or sell anything it may describe. Reproduction, disclosure or use without specific written authorization of Pulse is strictly forbidden.

CHARTS

LTE 1 and LTE2 VSWR

VSWR VS Frequency measured in free space

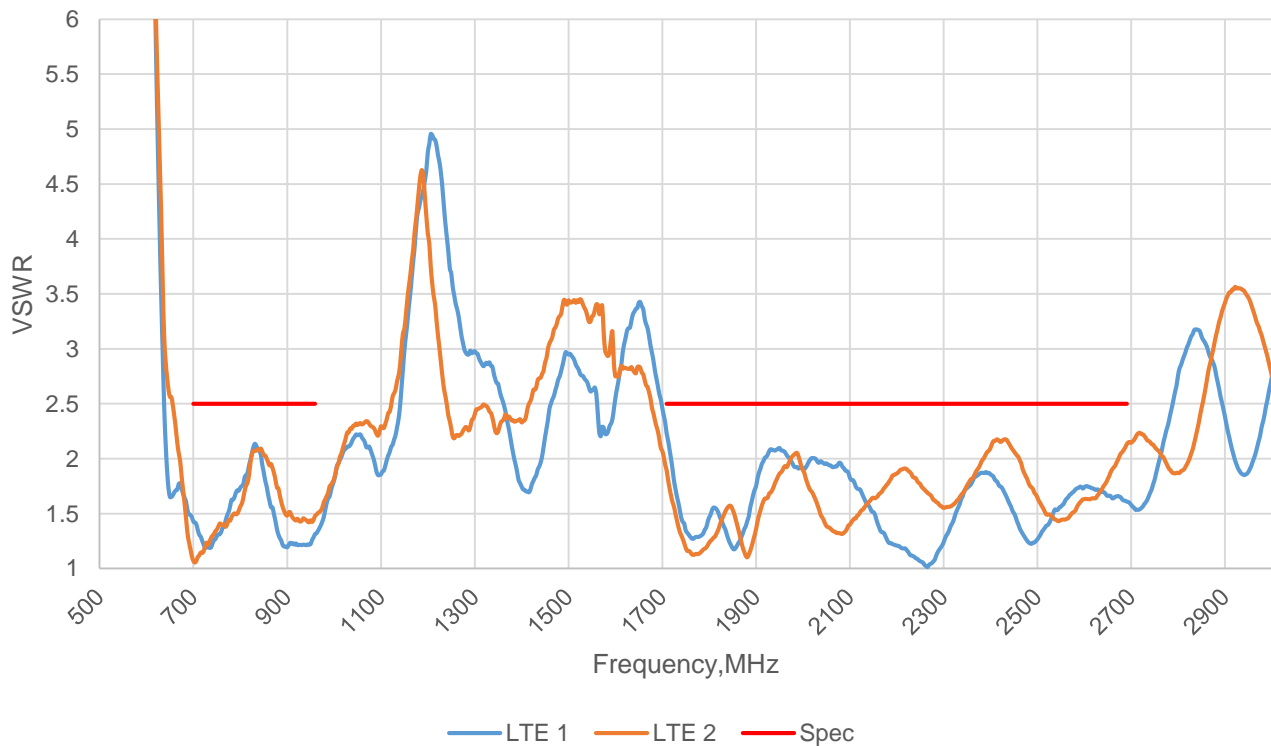

Series: Jaguar

Description: 2xLTE, WiFi, GNSS Multiband
Vehicular Antenna

PART NUMBER: GPSPMB401

CHARTS

WiFi VSWR*

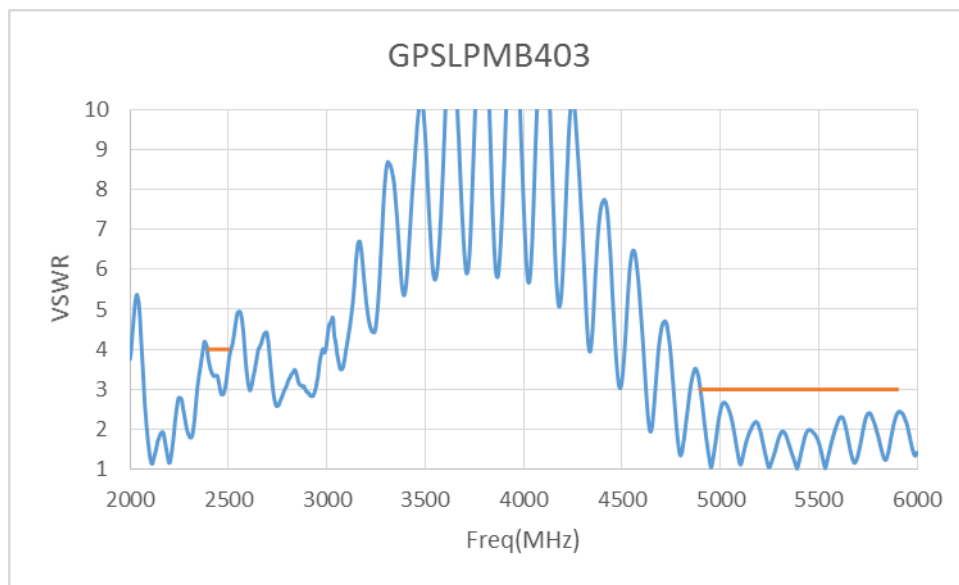

* Test on bracket and diameter is 500mm ground plane

Issue: 1720

In the effort to improve our products, we reserve the right to make changes judged to be necessary.

CONFIDENTIAL AND PROPRIETARY INFORMATION

This document contains confidential and proprietary information of Pulse Electronics, Inc. (Pulse) and is protected by copyright, trade secret and other state and federal laws. Its receipt or possession does not convey any rights to reproduce, disclose its contents, or to manufacture, use or sell anything it may describe. Reproduction, disclosure or use without specific written authorization of Pulse is strictly forbidden.

CHARTS

Isolation

Isolation vs Frequency measured in free space

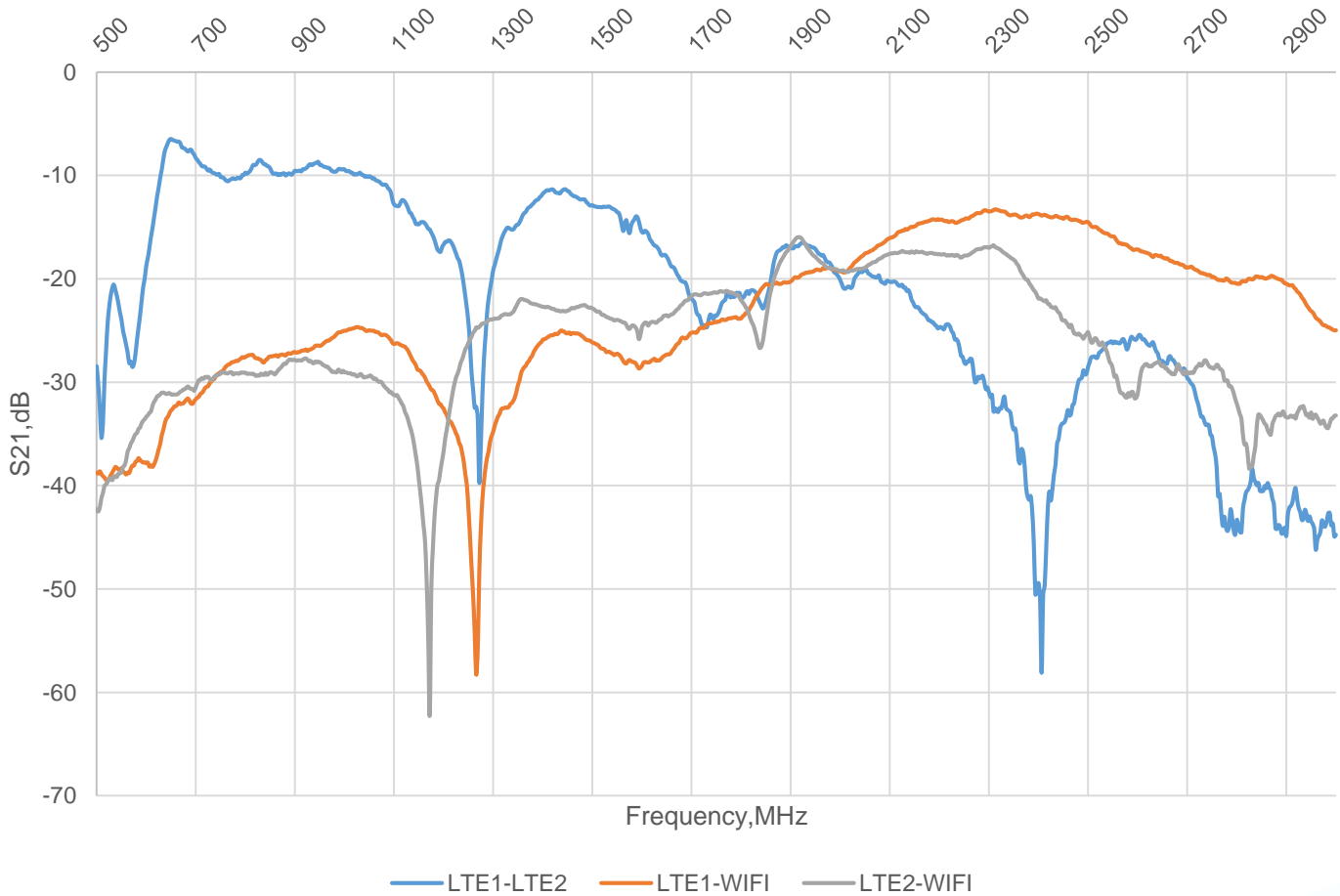

Series: Jaguar

Description: 2xLTE, WiFi, GNSS Multiband
Vehicular Antenna

PART NUMBER: GPSPMB401

CHARTS

GPS LNA Gain and out-of-band rejection

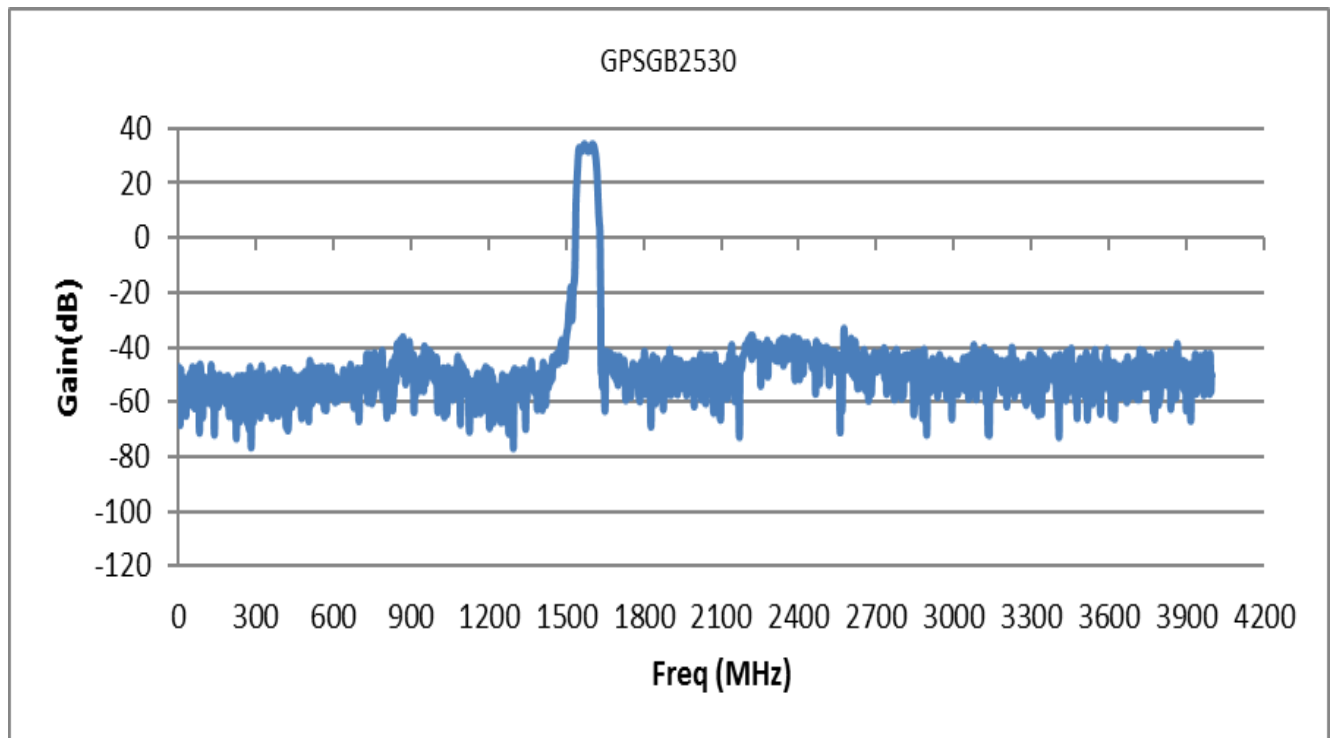

Issue: 1720

In the effort to improve our products, we reserve the right to make changes judged to be necessary.

CONFIDENTIAL AND PROPRIETARY INFORMATION

This document contains confidential and proprietary information of Pulse Electronics, Inc. (Pulse) and is protected by copyright, trade secret and other state and federal laws. Its receipt or possession does not convey any rights to reproduce, disclose its contents, or to manufacture, use or sell anything it may describe. Reproduction, disclosure or use without specific written authorization of Pulse is strictly forbidden.

CHARTS

LTE 1 and LTE2 Efficiency

Efficiency vs Frequency measured in free space

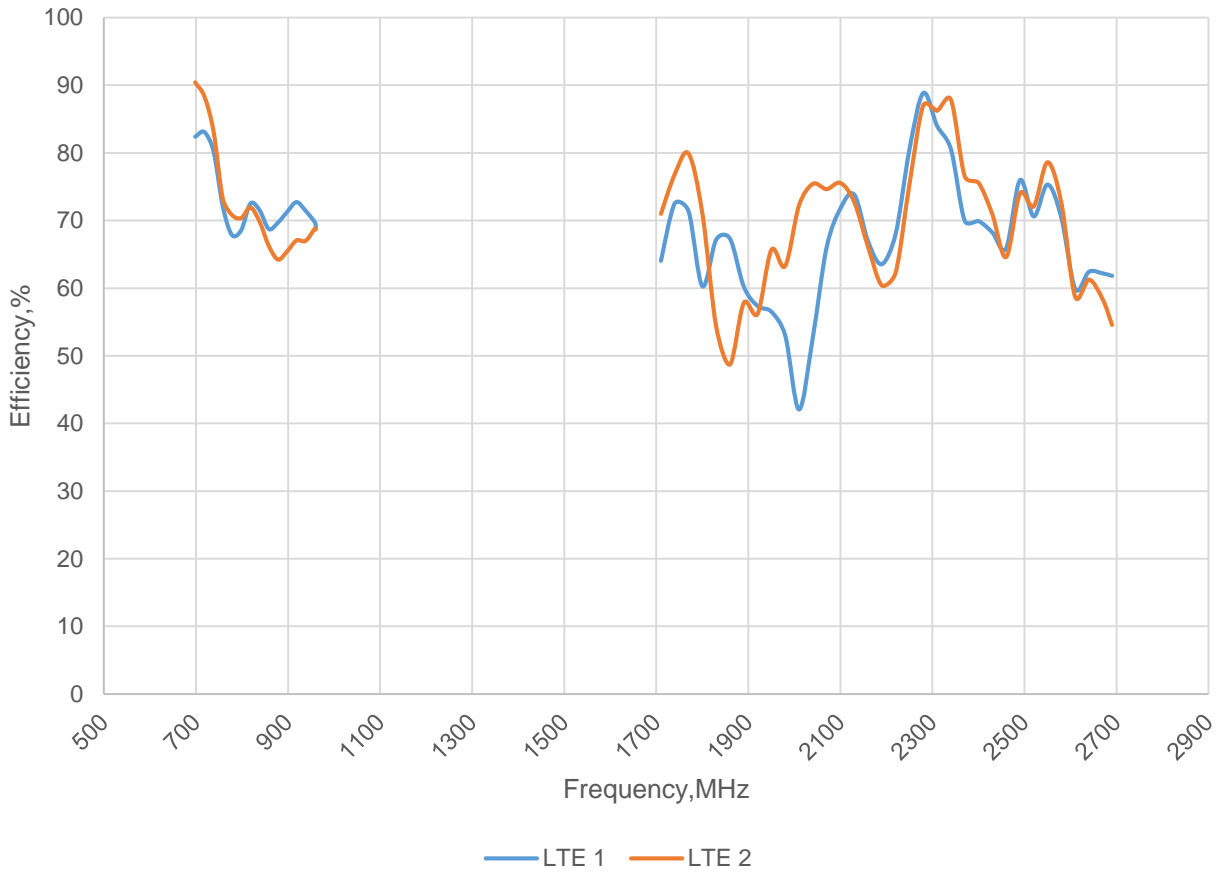

Series: Jaguar

Description: 2xLTE, WiFi, GNSS Multiband
Vehicular Antenna

PART NUMBER: GPSPMB401

CHARTS

WiFi Efficiency*

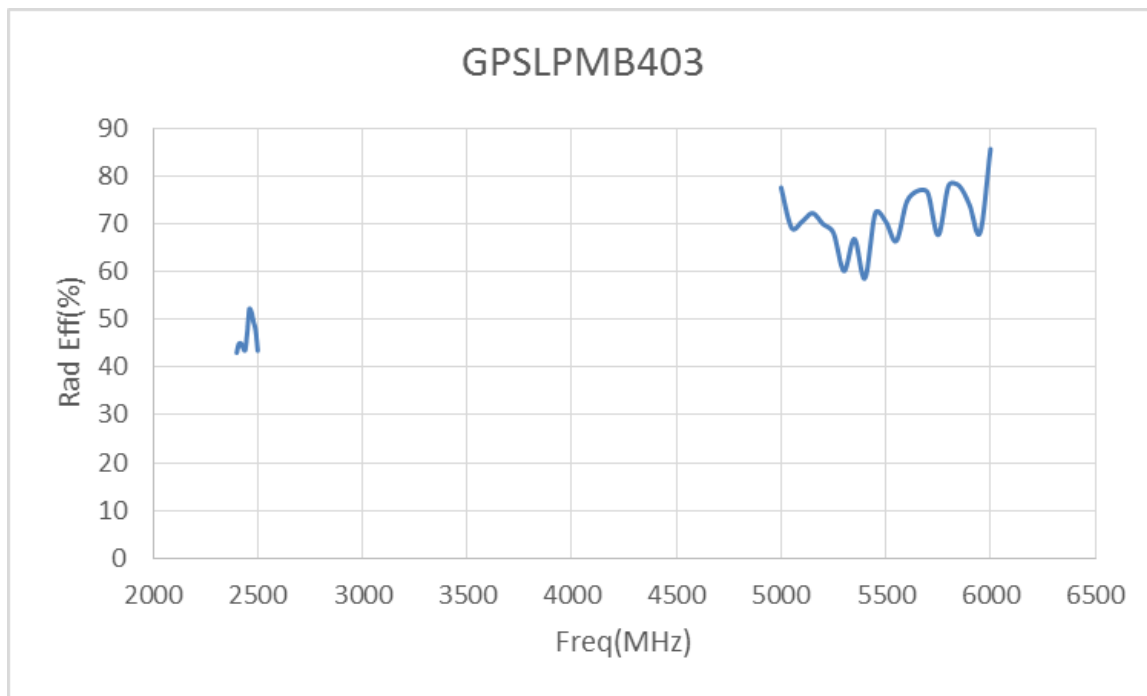

* Test on bracket and diameter is 500mm ground plane

Description: 2xLTE, WiFi, GNSS Multiband
Vehicular Antenna

Series: Jaguar

PART NUMBER: GPSPMB401

CHARTS

LTE1 and LTE2 Peak Gain

Peak Gain vs Frequency measured in free space

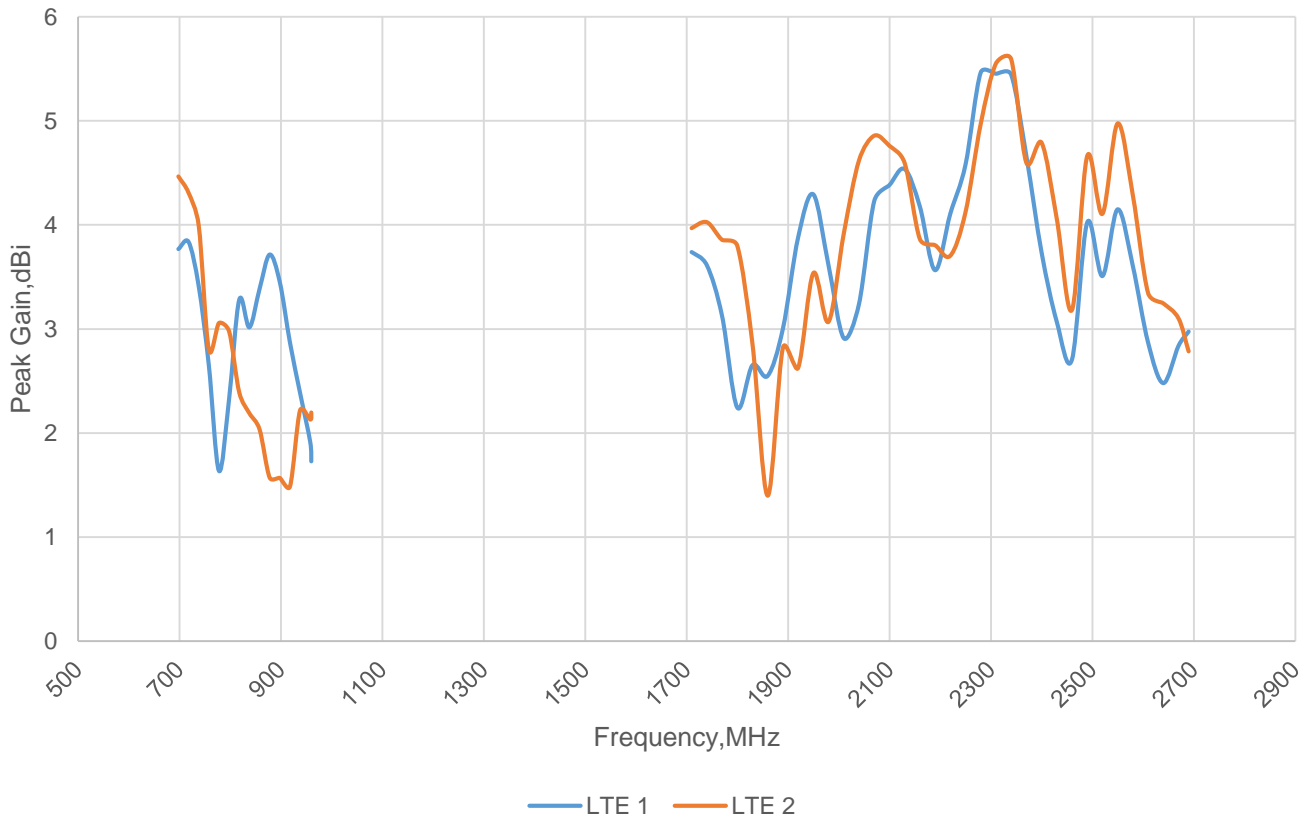

Issue: 1720

In the effort to improve our products, we reserve the right to make changes judged to be necessary.

CONFIDENTIAL AND PROPRIETARY INFORMATION

This document contains confidential and proprietary information of Pulse Electronics, Inc. (Pulse) and is protected by copyright, trade secret and other state and federal laws. Its receipt or possession does not convey any rights to reproduce, disclose its contents, or to manufacture, use or sell anything it may describe. Reproduction, disclosure or use without specific written authorization of Pulse is strictly forbidden.

Series: Jaguar

Description: 2xLTE, WiFi, GNSS Multiband
Vehicular Antenna

PART NUMBER: GPSPMB401

CHARTS

WiFi Peak Gain*

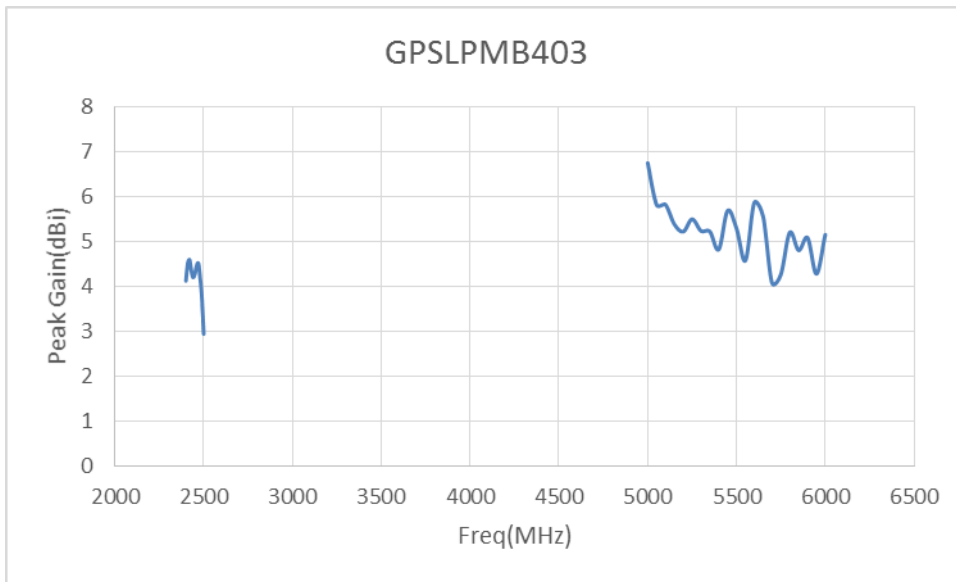

* Test on bracket and diameter is 500mm ground plane

Issue: 1720

In the effort to improve our products, we reserve the right to make changes judged to be necessary.
CONFIDENTIAL AND PROPRIETARY INFORMATION

This document contains confidential and proprietary information of Pulse Electronics, Inc. (Pulse) and is protected by copyright, trade secret and other state and federal laws. Its receipt or possession does not convey any rights to reproduce, disclose its contents, or to manufacture, use or sell anything it may describe. Reproduction, disclosure or use without specific written authorization of Pulse is strictly forbidden.

Description: 2xLTE, WiFi, GNSS Multiband
Vehicular Antenna

Series: Jaguar

PART NUMBER: GPSPMB401

CHARTS

Gain Plots LTE1

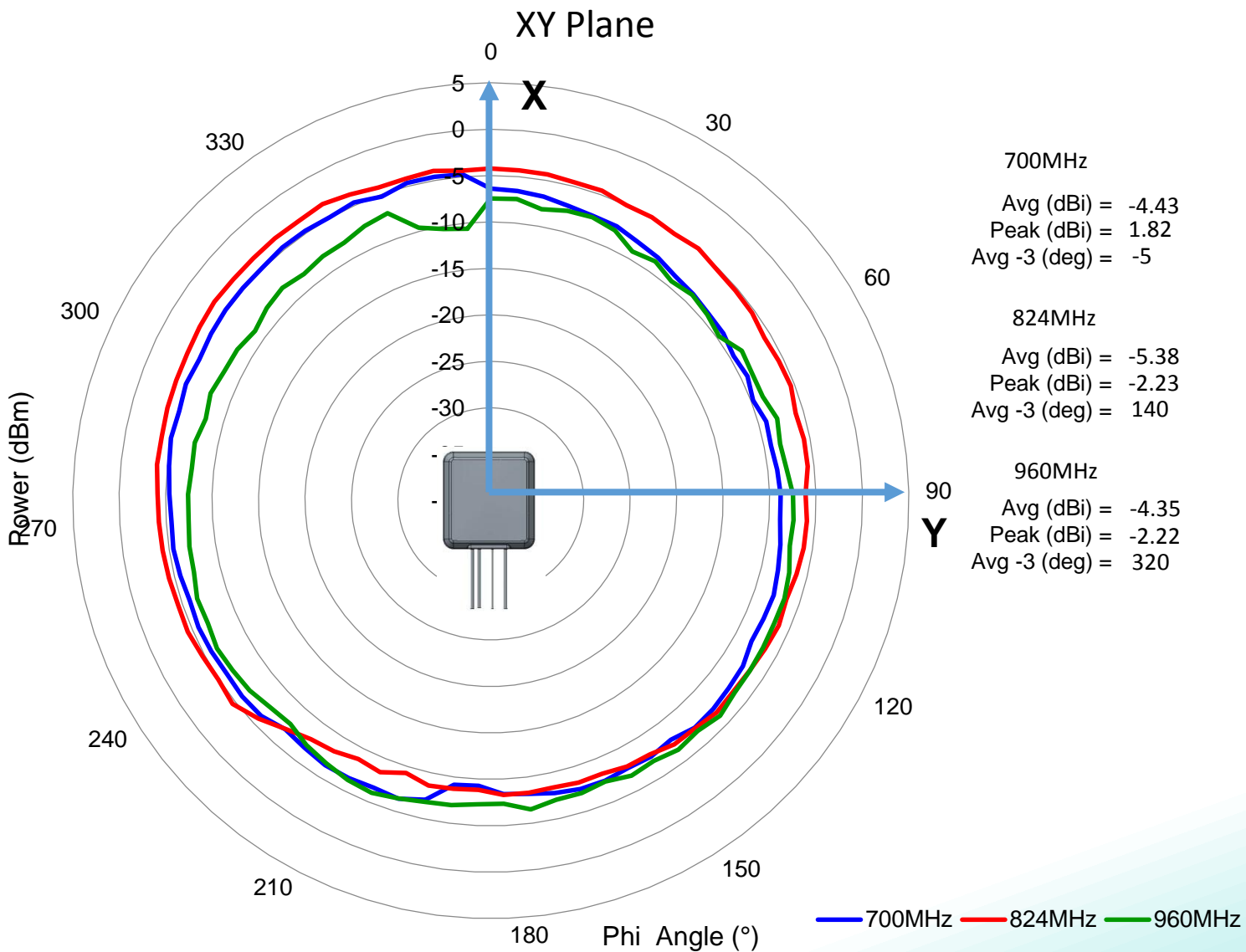

Issue: 1720

In the effort to improve our products, we reserve the right to make changes judged to be necessary.

CONFIDENTIAL AND PROPRIETARY INFORMATION

This document contains confidential and proprietary information of Pulse Electronics, Inc. (Pulse) and is protected by copyright, trade secret and other state and federal laws. Its receipt or possession does not convey any rights to reproduce, disclose its contents, or to manufacture, use or sell anything it may describe. Reproduction, disclosure or use without specific written authorization of Pulse is strictly forbidden.

Description: 2xLTE, WiFi, GNSS Multiband
Vehicular Antenna

Series: Jaguar

PART NUMBER: GPSPMB401

CHARTS

Gain Plots LTE1

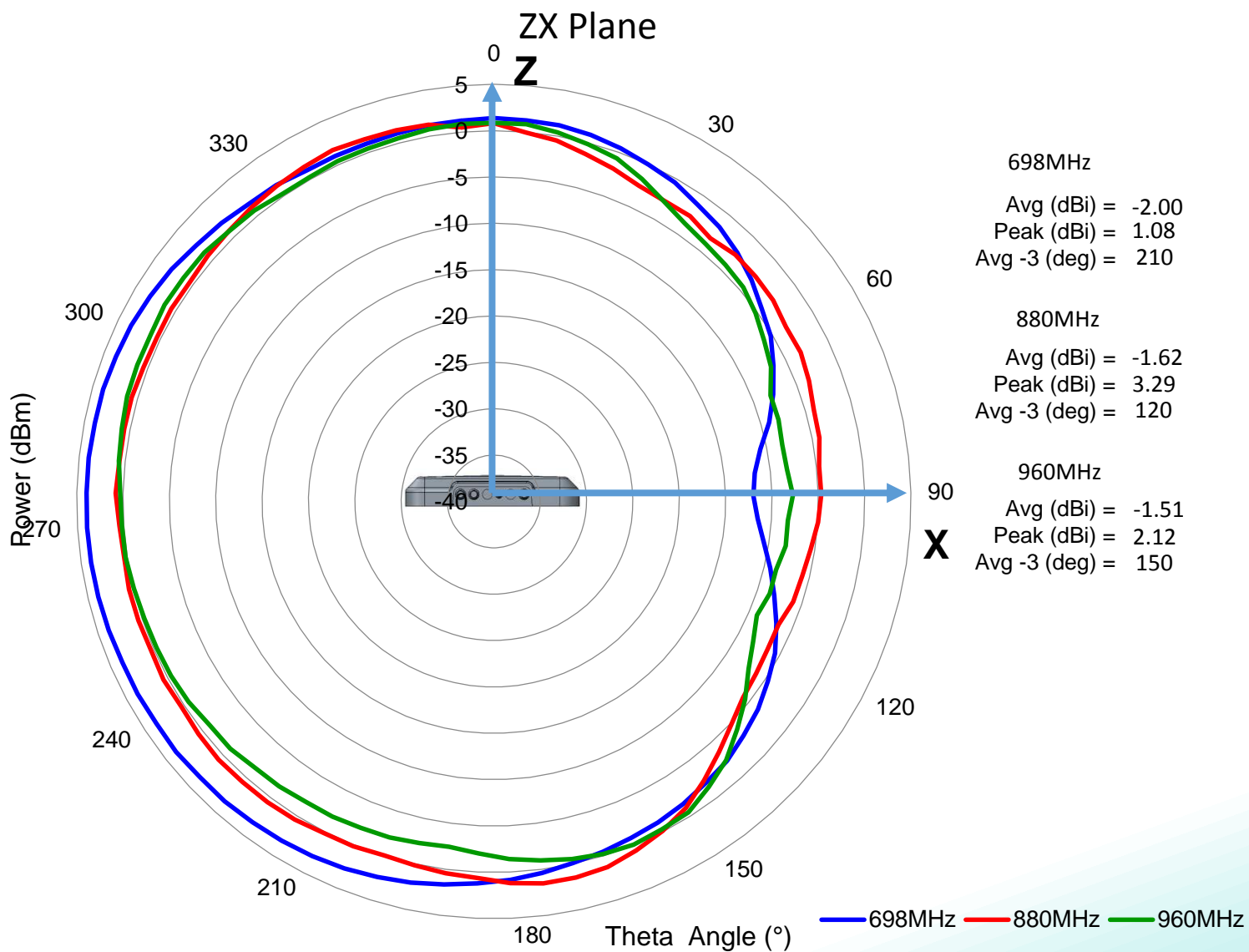

Issue: 1720

In the effort to improve our products, we reserve the right to make changes judged to be necessary.

CONFIDENTIAL AND PROPRIETARY INFORMATION

This document contains confidential and proprietary information of Pulse Electronics, Inc. (Pulse) and is protected by copyright, trade secret and other state and federal laws. Its receipt or possession does not convey any rights to reproduce, disclose its contents, or to manufacture, use or sell anything it may describe. Reproduction, disclosure or use without specific written authorization of Pulse is strictly forbidden.

CHARTS

Gain Plots LTE1

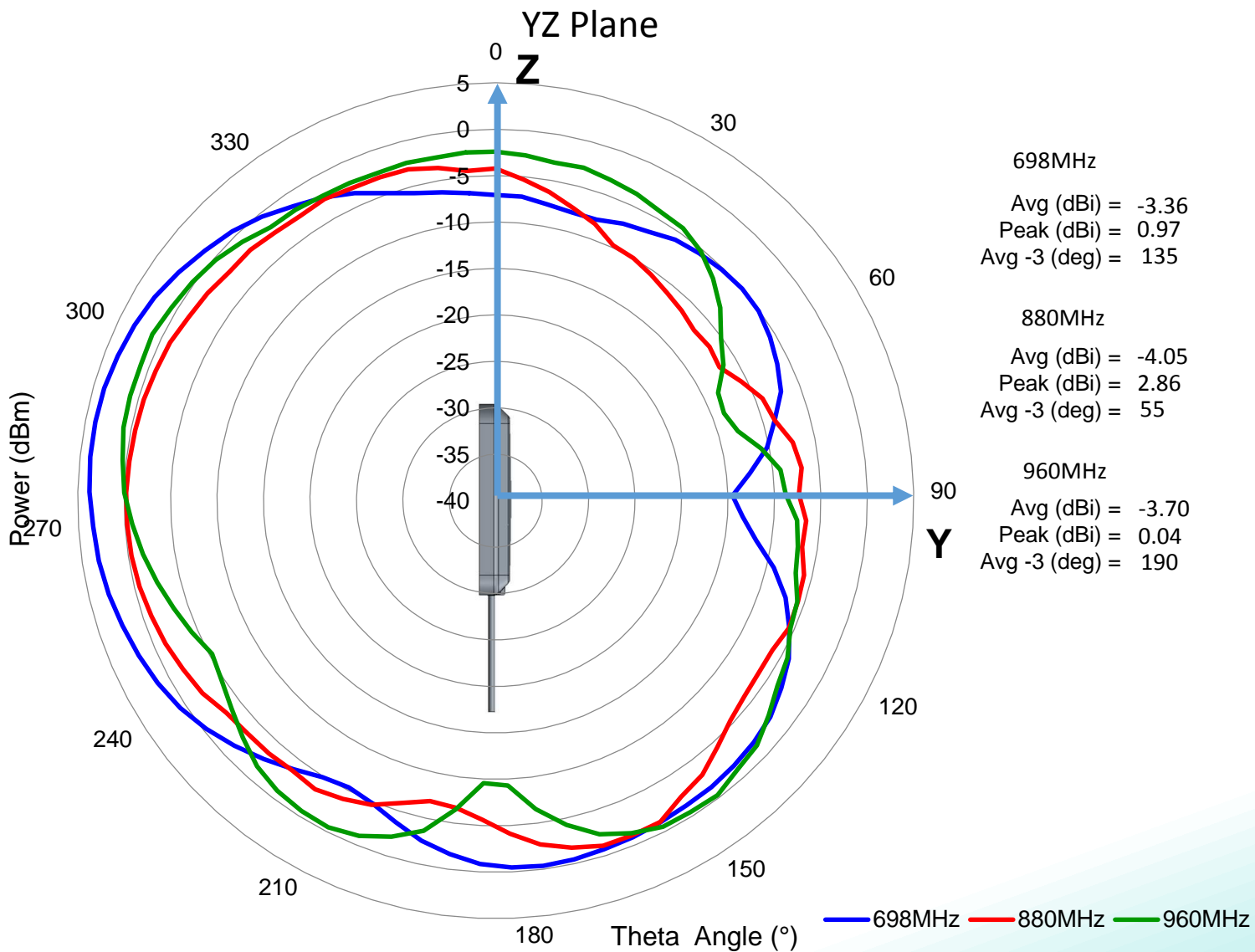

Issue: 1720

In the effort to improve our products, we reserve the right to make changes judged to be necessary.

CONFIDENTIAL AND PROPRIETARY INFORMATION

This document contains confidential and proprietary information of Pulse Electronics, Inc. (Pulse) and is protected by copyright, trade secret and other state and federal laws. Its receipt or possession does not convey any rights to reproduce, disclose its contents, or to manufacture, use or sell anything it may describe. Reproduction, disclosure or use without specific written authorization of Pulse is strictly forbidden.

CHARTS

Gain Plots LTE1

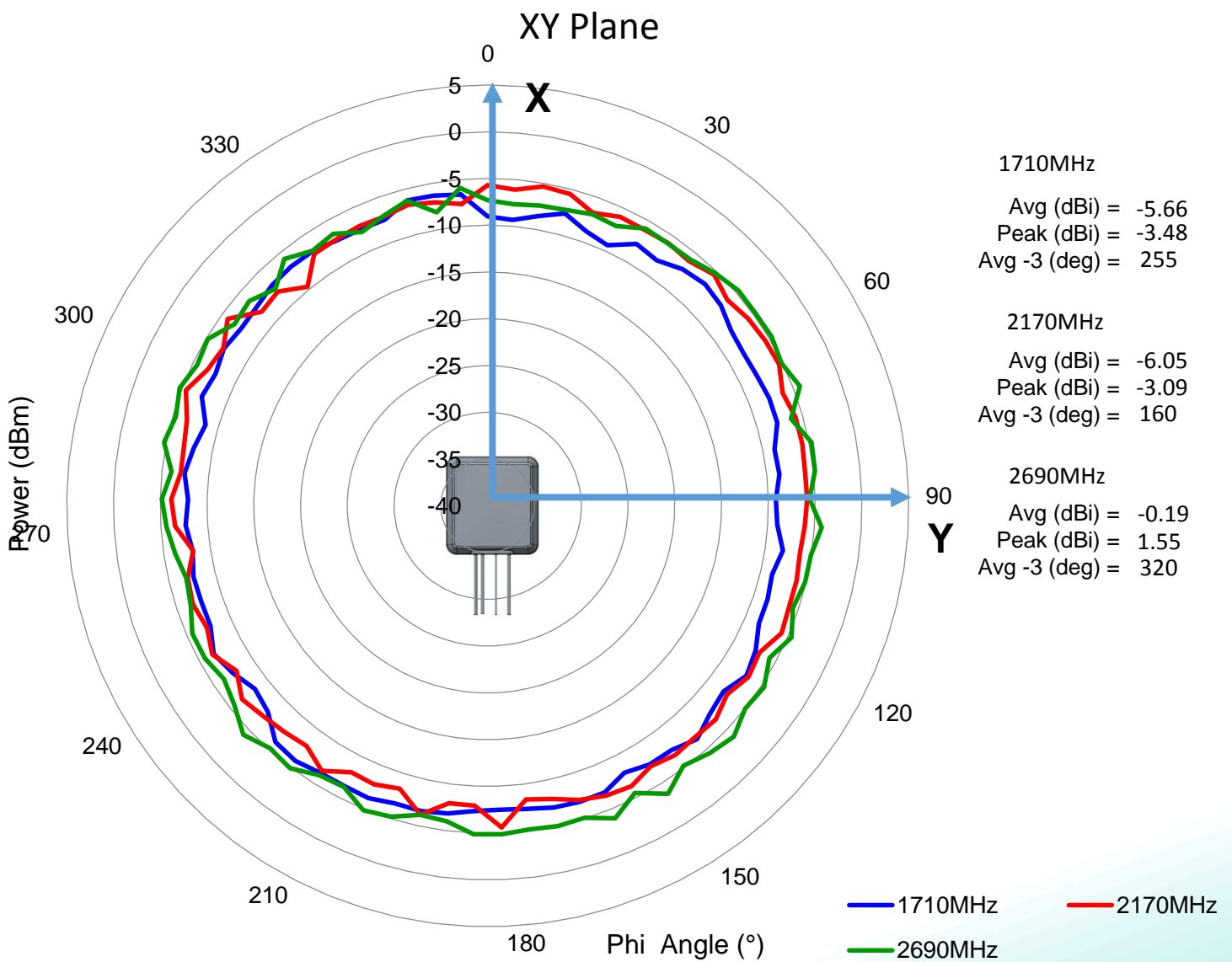

Issue: 1720

In the effort to improve our products, we reserve the right to make changes judged to be necessary.

CONFIDENTIAL AND PROPRIETARY INFORMATION

This document contains confidential and proprietary information of Pulse Electronics, Inc. (Pulse) and is protected by copyright, trade secret and other state and federal laws. Its receipt or possession does not convey any rights to reproduce, disclose its contents, or to manufacture, use or sell anything it may describe. Reproduction, disclosure or use without specific written authorization of Pulse is strictly forbidden.

CHARTS

Gain Plots LTE1

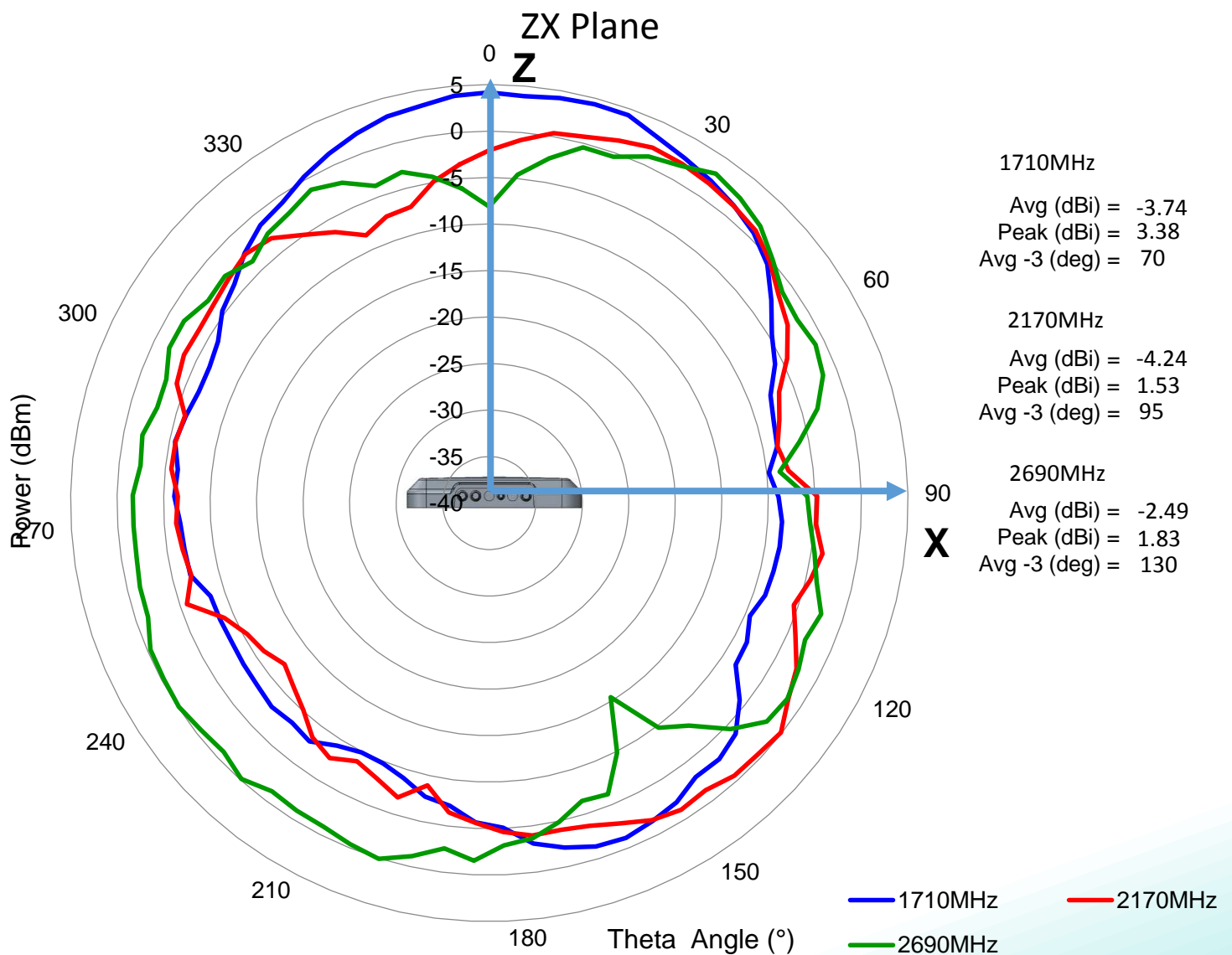

Issue: 1720

In the effort to improve our products, we reserve the right to make changes judged to be necessary.
CONFIDENTIAL AND PROPRIETARY INFORMATION

This document contains confidential and proprietary information of Pulse Electronics, Inc. (Pulse) and is protected by copyright, trade secret and other state and federal laws. Its receipt or possession does not convey any rights to reproduce, disclose its contents, or to manufacture, use or sell anything it may describe. Reproduction, disclosure or use without specific written authorization of Pulse is strictly forbidden.

Series: Jaguar

Description: 2xLTE, WiFi, GNSS Multiband
Vehicular Antenna

PART NUMBER: GPSPMB401

CHARTS

Gain Plots LTE1

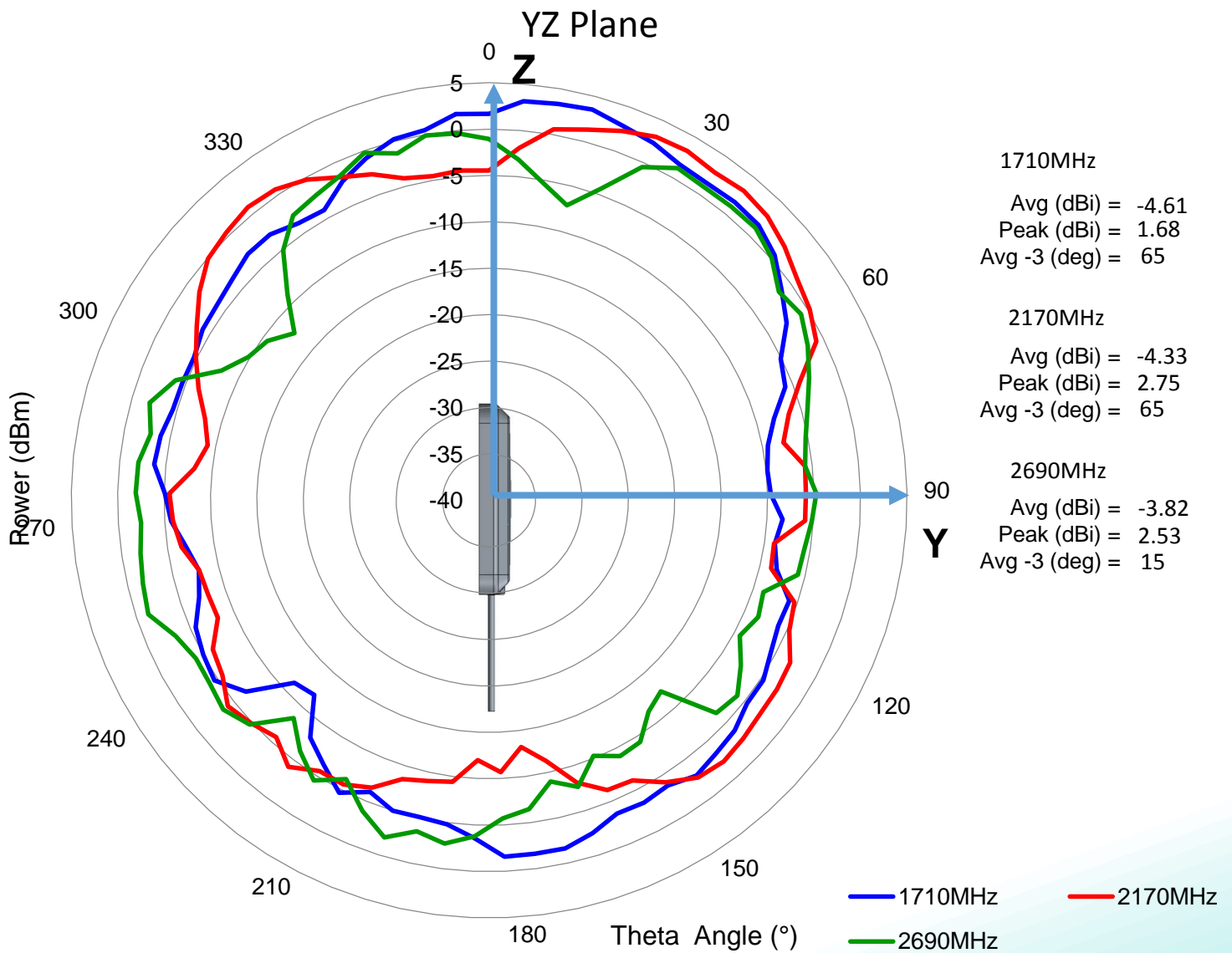

Issue: 1720

In the effort to improve our products, we reserve the right to make changes judged to be necessary.

CONFIDENTIAL AND PROPRIETARY INFORMATION

This document contains confidential and proprietary information of Pulse Electronics, Inc. (Pulse) and is protected by copyright, trade secret and other state and federal laws. Its receipt or possession does not convey any rights to reproduce, disclose its contents, or to manufacture, use or sell anything it may describe. Reproduction, disclosure or use without specific written authorization of Pulse is strictly forbidden.

Description: 2xLTE, WiFi, GNSS Multiband
Vehicular Antenna

Series: Jaguar

PART NUMBER: GPSPMB401

CHARTS

Gain Plots LTE2

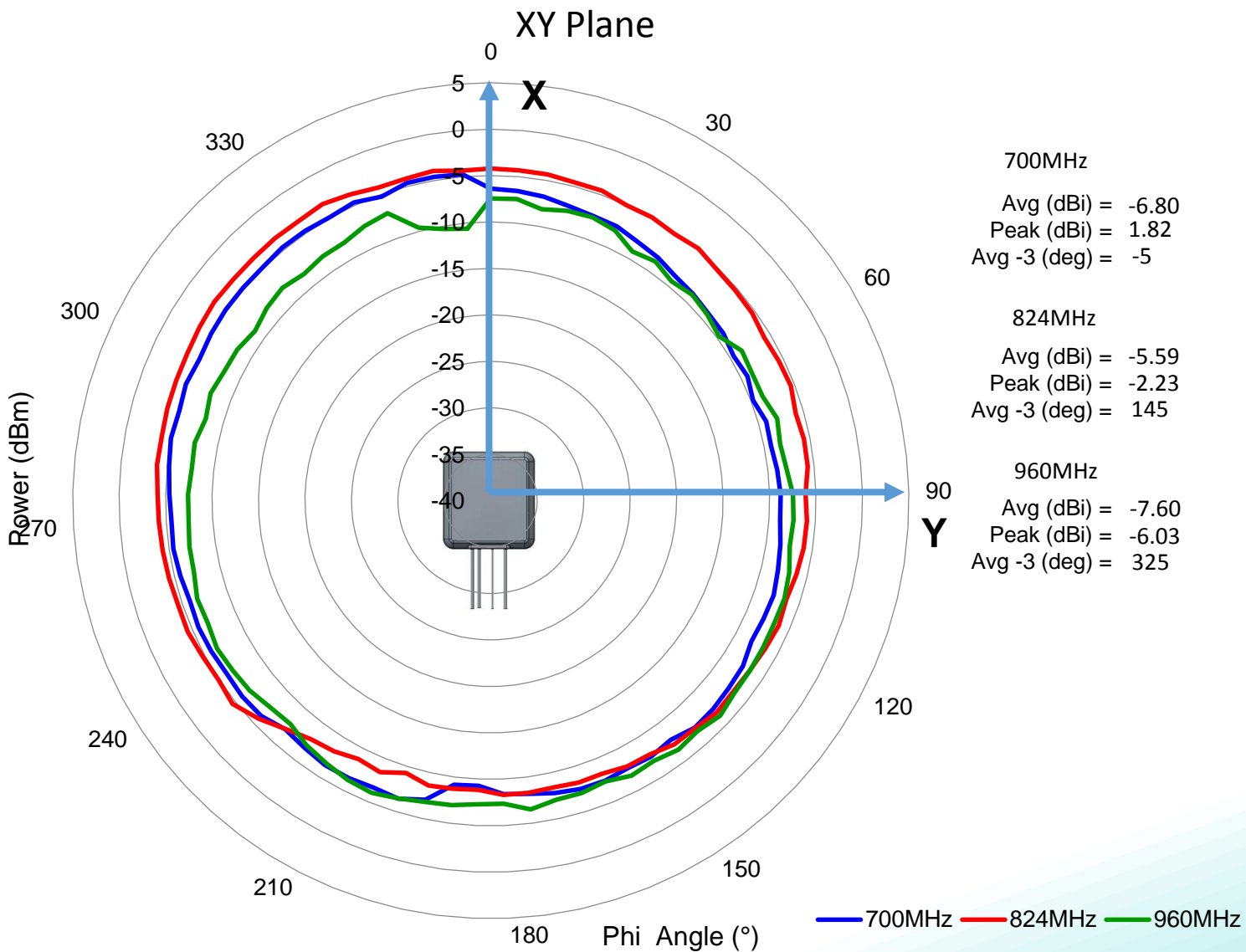

Issue: 1720

In the effort to improve our products, we reserve the right to make changes judged to be necessary.

CONFIDENTIAL AND PROPRIETARY INFORMATION

This document contains confidential and proprietary information of Pulse Electronics, Inc. (Pulse) and is protected by copyright, trade secret and other state and federal laws. Its receipt or possession does not convey any rights to reproduce, disclose its contents, or to manufacture, use or sell anything it may describe. Reproduction, disclosure or use without specific written authorization of Pulse is strictly forbidden.

Description: 2xLTE, WiFi, GNSS Multiband
Vehicular Antenna

Series: Jaguar

PART NUMBER: GPSPMB401

CHARTS

Gain Plots LTE2

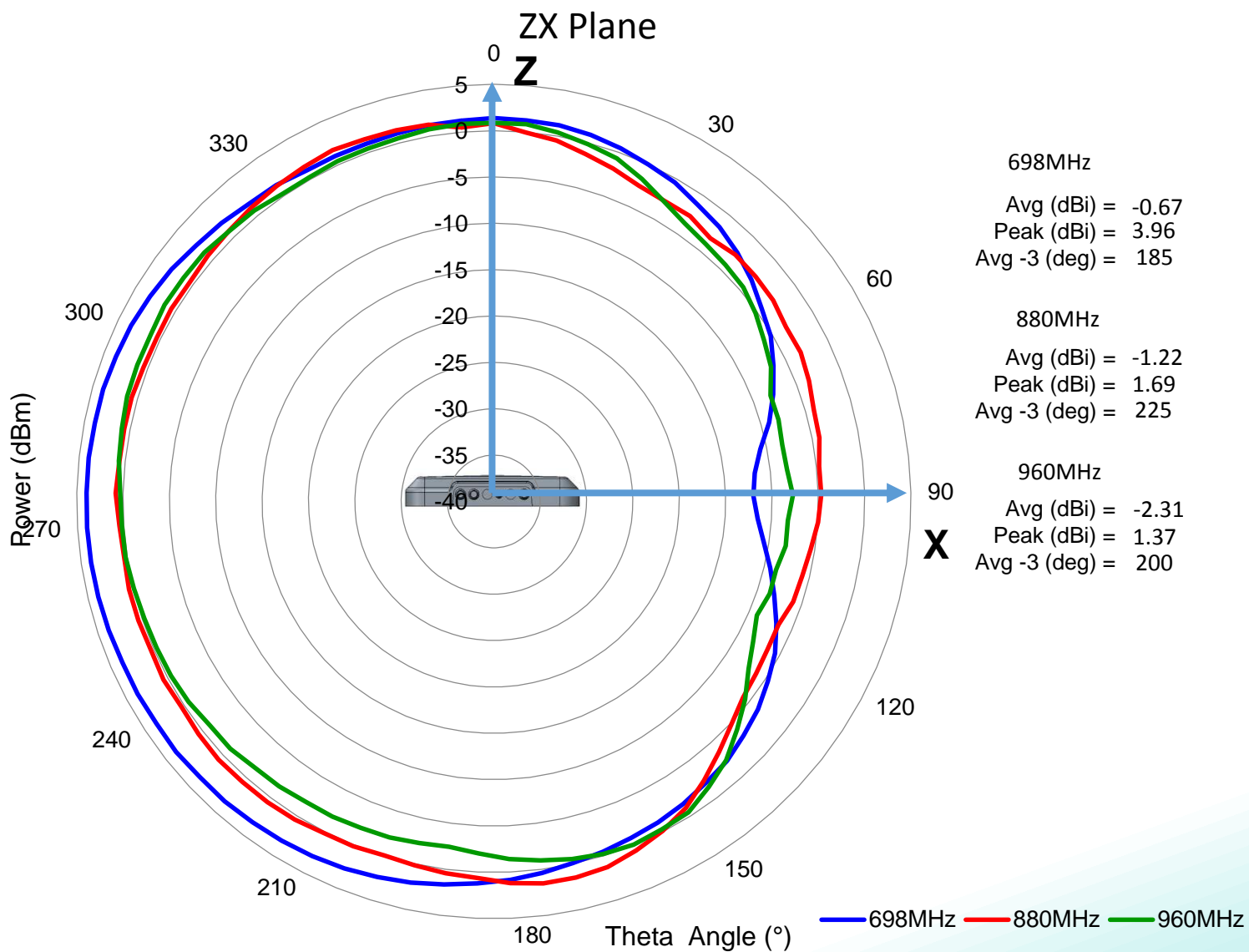

Issue: 1720

In the effort to improve our products, we reserve the right to make changes judged to be necessary.

CONFIDENTIAL AND PROPRIETARY INFORMATION

This document contains confidential and proprietary information of Pulse Electronics, Inc. (Pulse) and is protected by copyright, trade secret and other state and federal laws. Its receipt or possession does not convey any rights to reproduce, disclose its contents, or to manufacture, use or sell anything it may describe. Reproduction, disclosure or use without specific written authorization of Pulse is strictly forbidden.

CHARTS

Gain Plots LTE2

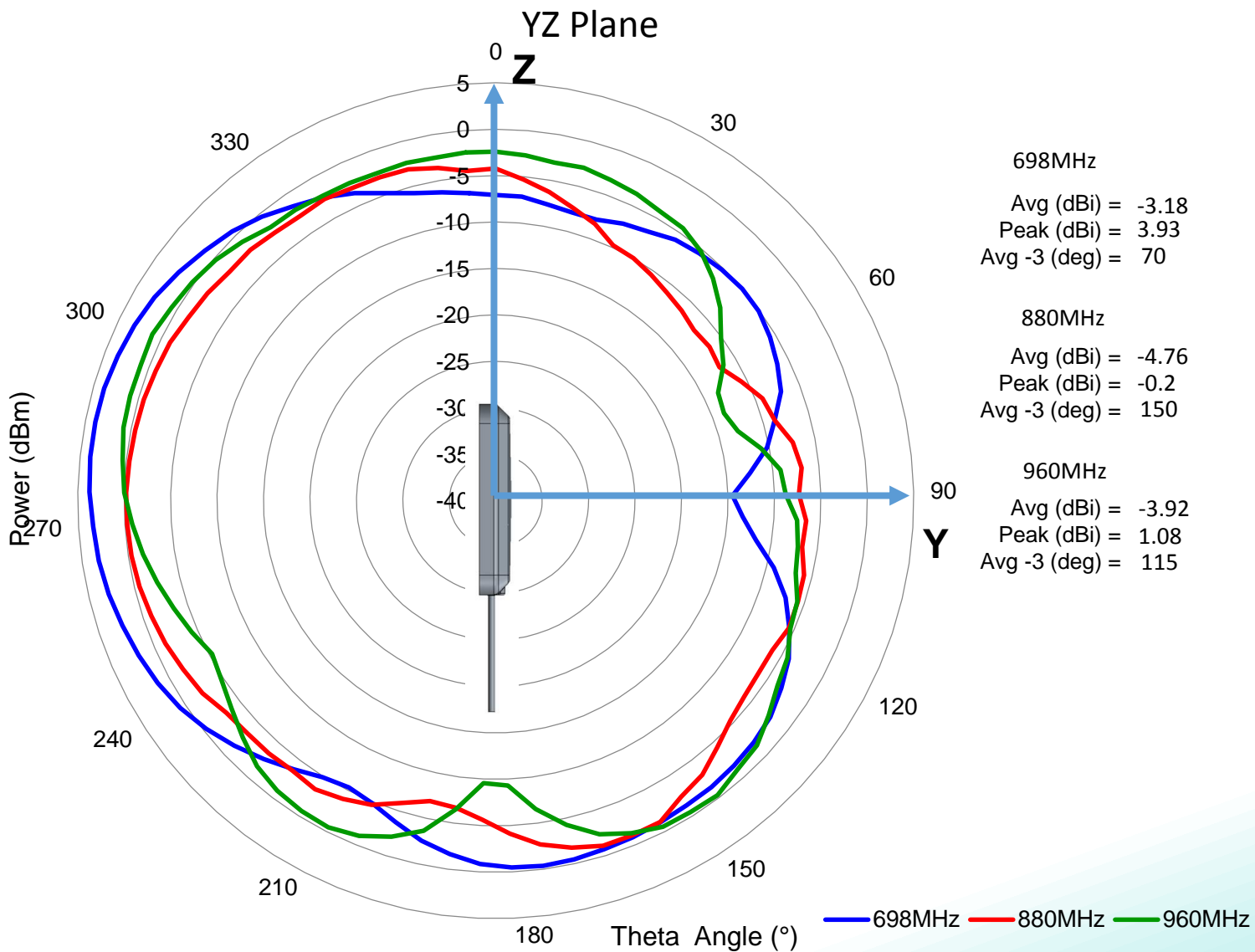

Issue: 1720

In the effort to improve our products, we reserve the right to make changes judged to be necessary.

CONFIDENTIAL AND PROPRIETARY INFORMATION

This document contains confidential and proprietary information of Pulse Electronics, Inc. (Pulse) and is protected by copyright, trade secret and other state and federal laws. Its receipt or possession does not convey any rights to reproduce, disclose its contents, or to manufacture, use or sell anything it may describe. Reproduction, disclosure or use without specific written authorization of Pulse is strictly forbidden.

CHARTS

Gain Plots LTE2

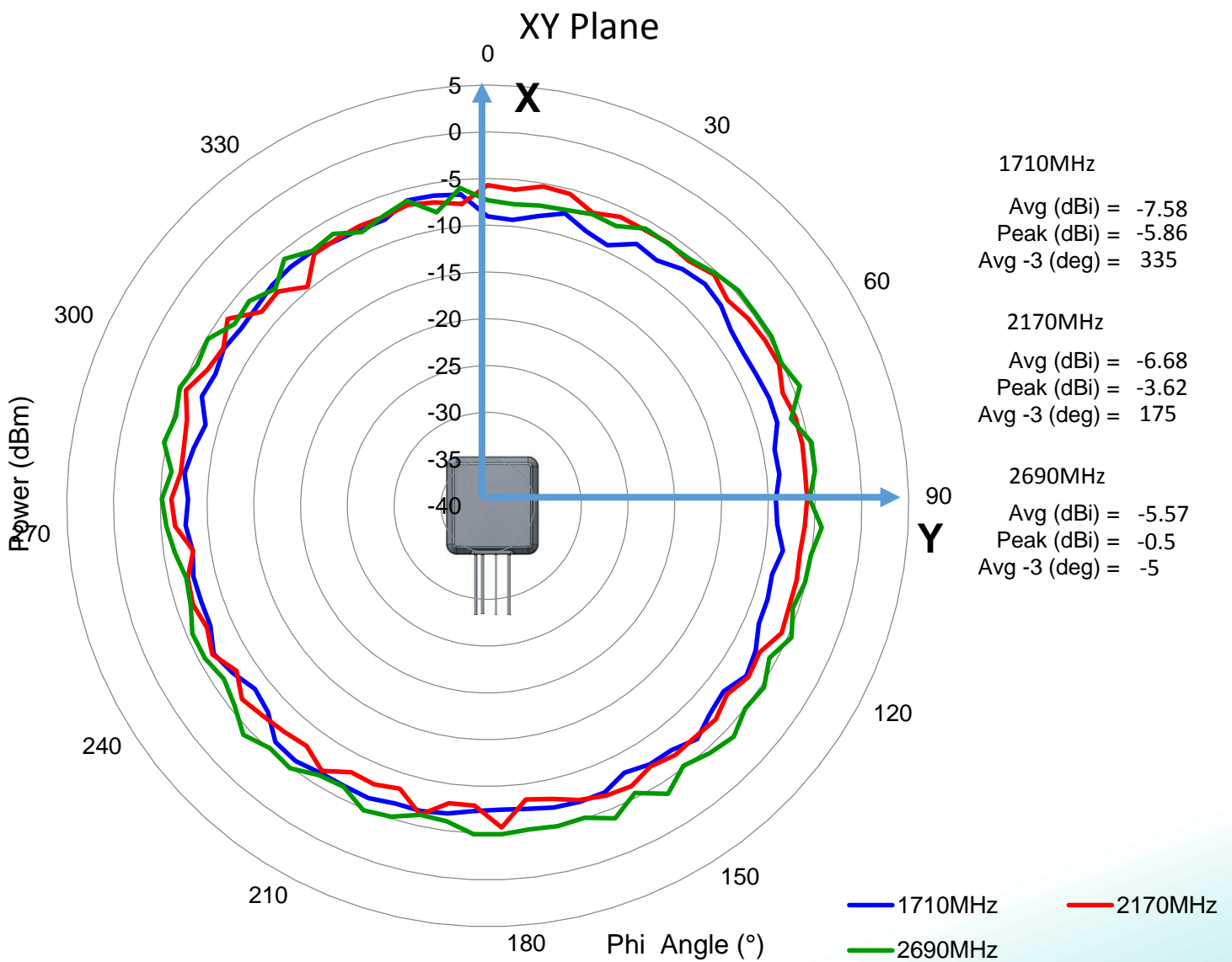

Issue: 1720

In the effort to improve our products, we reserve the right to make changes judged to be necessary.

CONFIDENTIAL AND PROPRIETARY INFORMATION

This document contains confidential and proprietary information of Pulse Electronics, Inc. (Pulse) and is protected by copyright, trade secret and other state and federal laws. Its receipt or possession does not convey any rights to reproduce, disclose its contents, or to manufacture, use or sell anything it may describe. Reproduction, disclosure or use without specific written authorization of Pulse is strictly forbidden.

Series: Jaguar

Description: 2xLTE, WiFi, GNSS Multiband
Vehicular Antenna

PART NUMBER: GPSPMB401

CHARTS

Gain Plots LTE2

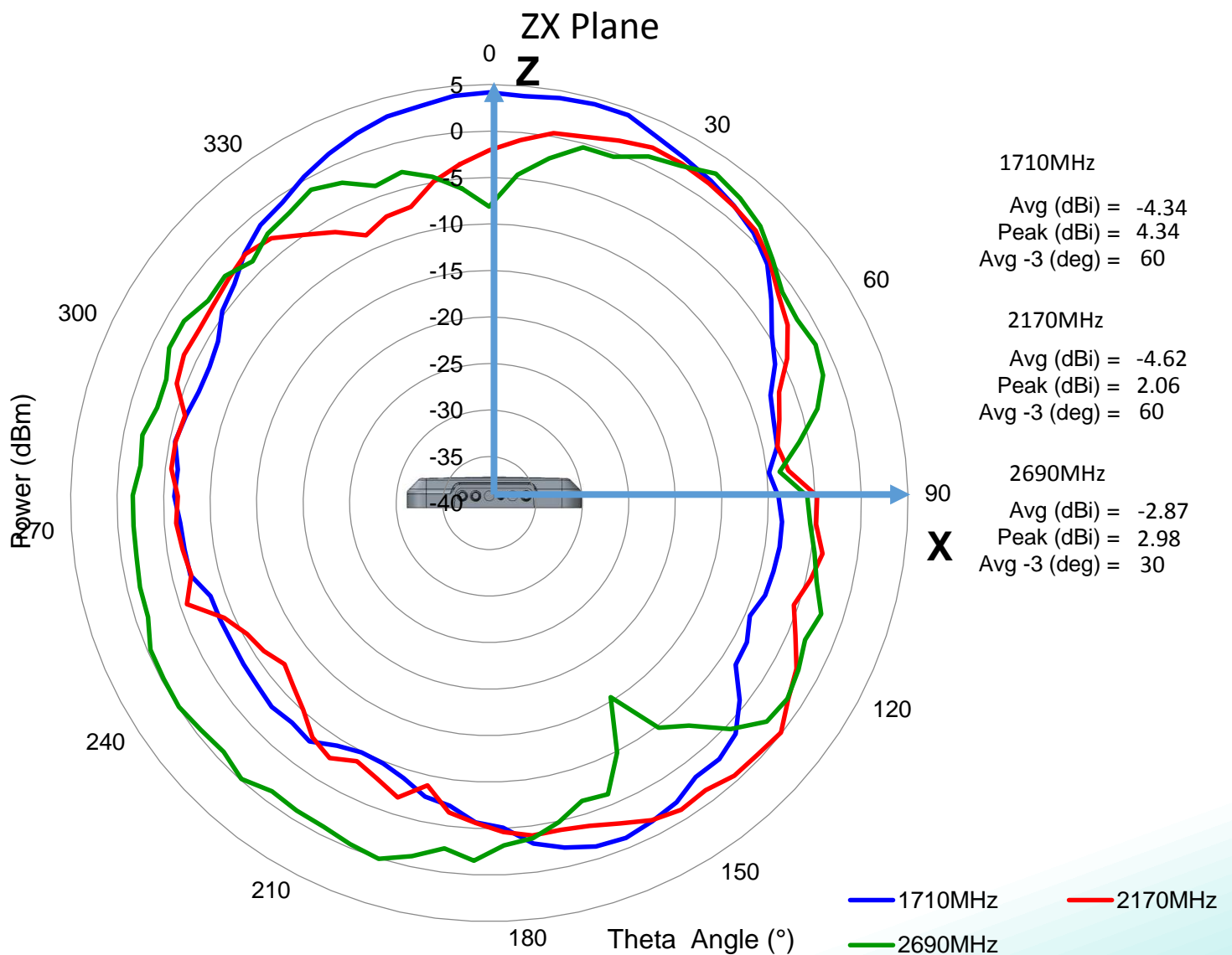

Issue: 1720

In the effort to improve our products, we reserve the right to make changes judged to be necessary.

CONFIDENTIAL AND PROPRIETARY INFORMATION

This document contains confidential and proprietary information of Pulse Electronics, Inc. (Pulse) and is protected by copyright, trade secret and other state and federal laws. Its receipt or possession does not convey any rights to reproduce, disclose its contents, or to manufacture, use or sell anything it may describe. Reproduction, disclosure or use without specific written authorization of Pulse is strictly forbidden.

Series: Jaguar

Description: 2xLTE, WiFi, GNSS Multiband
Vehicular Antenna

PART NUMBER: GPSPMB401

CHARTS

Gain Plots LTE2

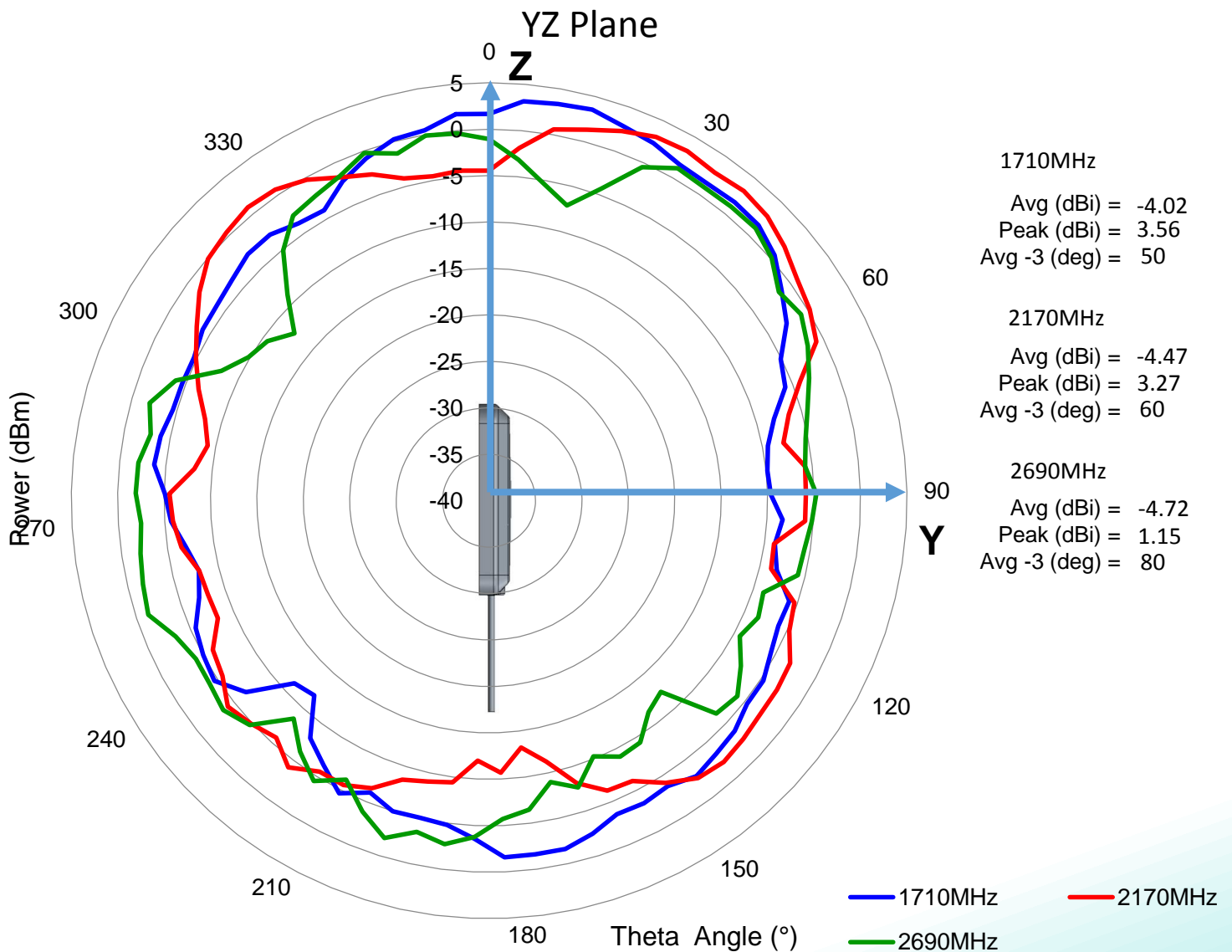

Issue: 1720

In the effort to improve our products, we reserve the right to make changes judged to be necessary.

CONFIDENTIAL AND PROPRIETARY INFORMATION

This document contains confidential and proprietary information of Pulse Electronics, Inc. (Pulse) and is protected by copyright, trade secret and other state and federal laws. Its receipt or possession does not convey any rights to reproduce, disclose its contents, or to manufacture, use or sell anything it may describe. Reproduction, disclosure or use without specific written authorization of Pulse is strictly forbidden.

CHARTS

Gain Plots WIFI*

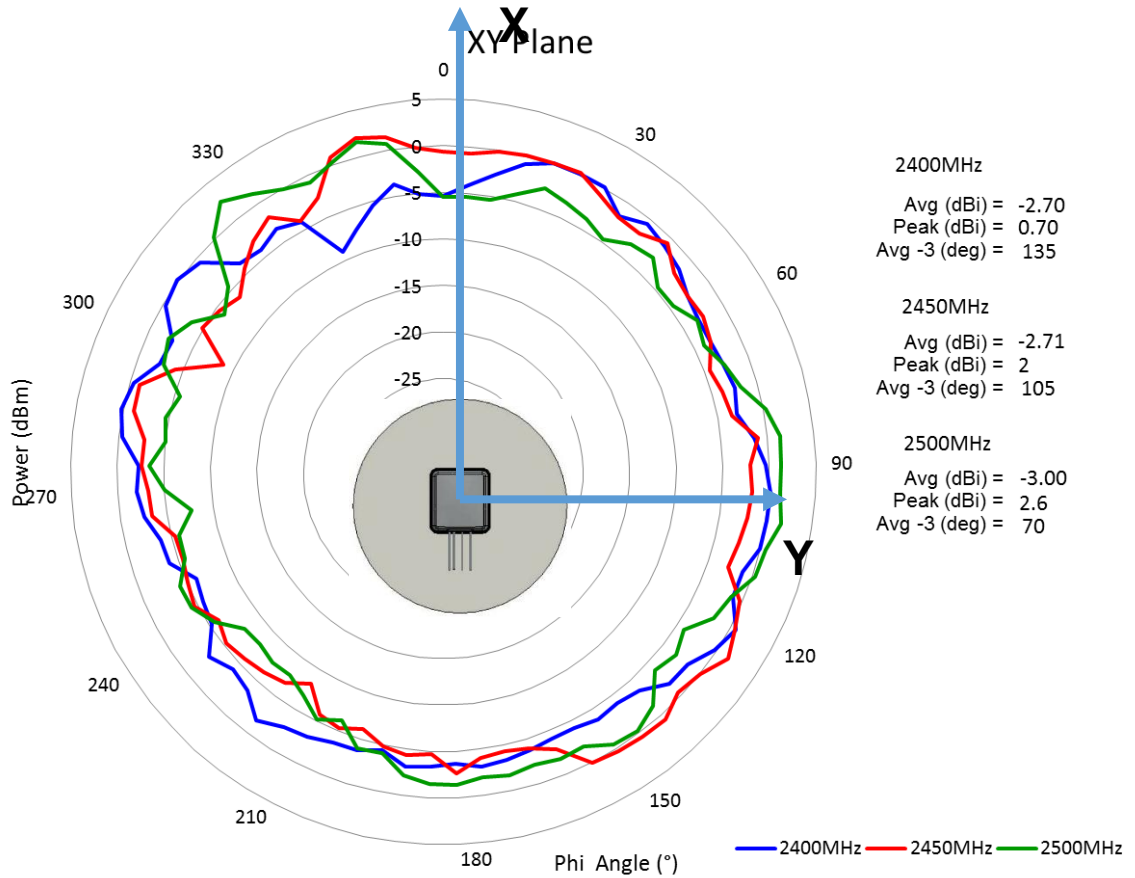

* Test on bracket and diameter is 500mm ground plane

Description: 2xLTE, WiFi, GNSS Multiband
Vehicular Antenna

Series: Jaguar

PART NUMBER: GPSPMB401

CHARTS

Gain Plots WIFI*

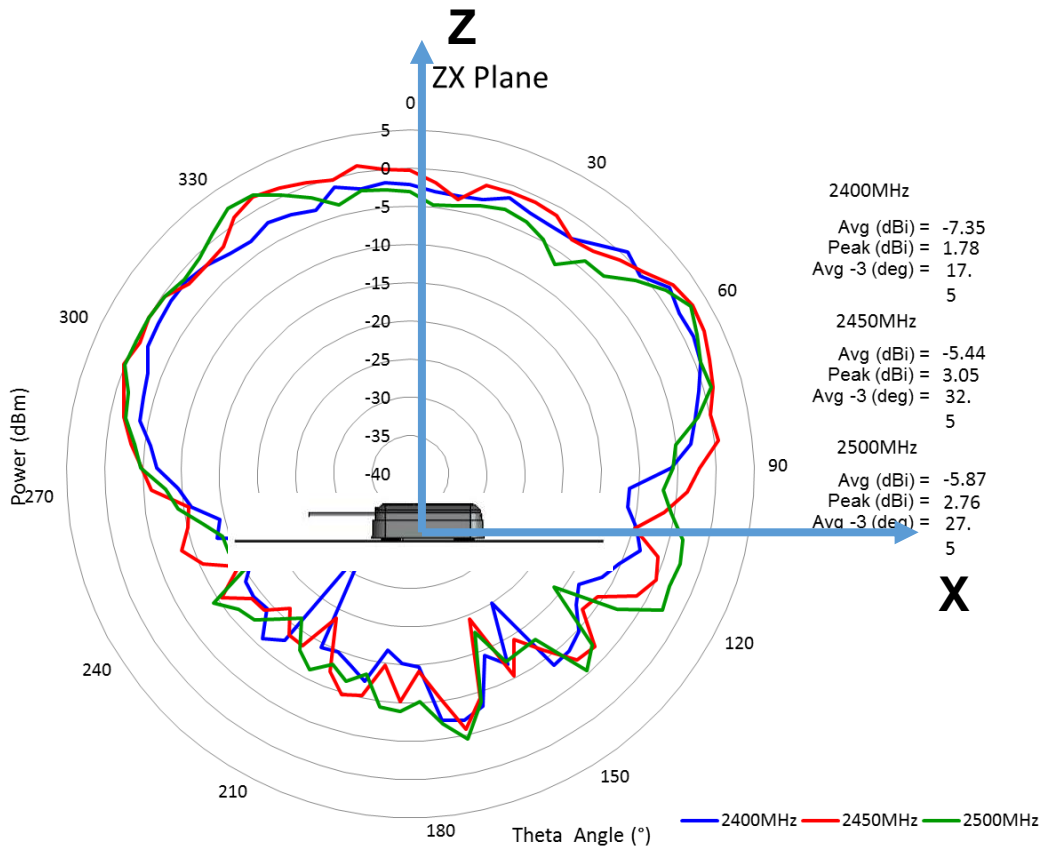

* Test on bracket and diameter is 500mm ground plane

Issue: 1720

In the effort to improve our products, we reserve the right to make changes judged to be necessary.
CONFIDENTIAL AND PROPRIETARY INFORMATION

This document contains confidential and proprietary information of Pulse Electronics, Inc. (Pulse) and is protected by copyright, trade secret and other state and federal laws. Its receipt or possession does not convey any rights to reproduce, disclose its contents, or to manufacture, use or sell anything it may describe. Reproduction, disclosure or use without specific written authorization of Pulse is strictly forbidden.

CHARTS

Gain Plots WIFI*

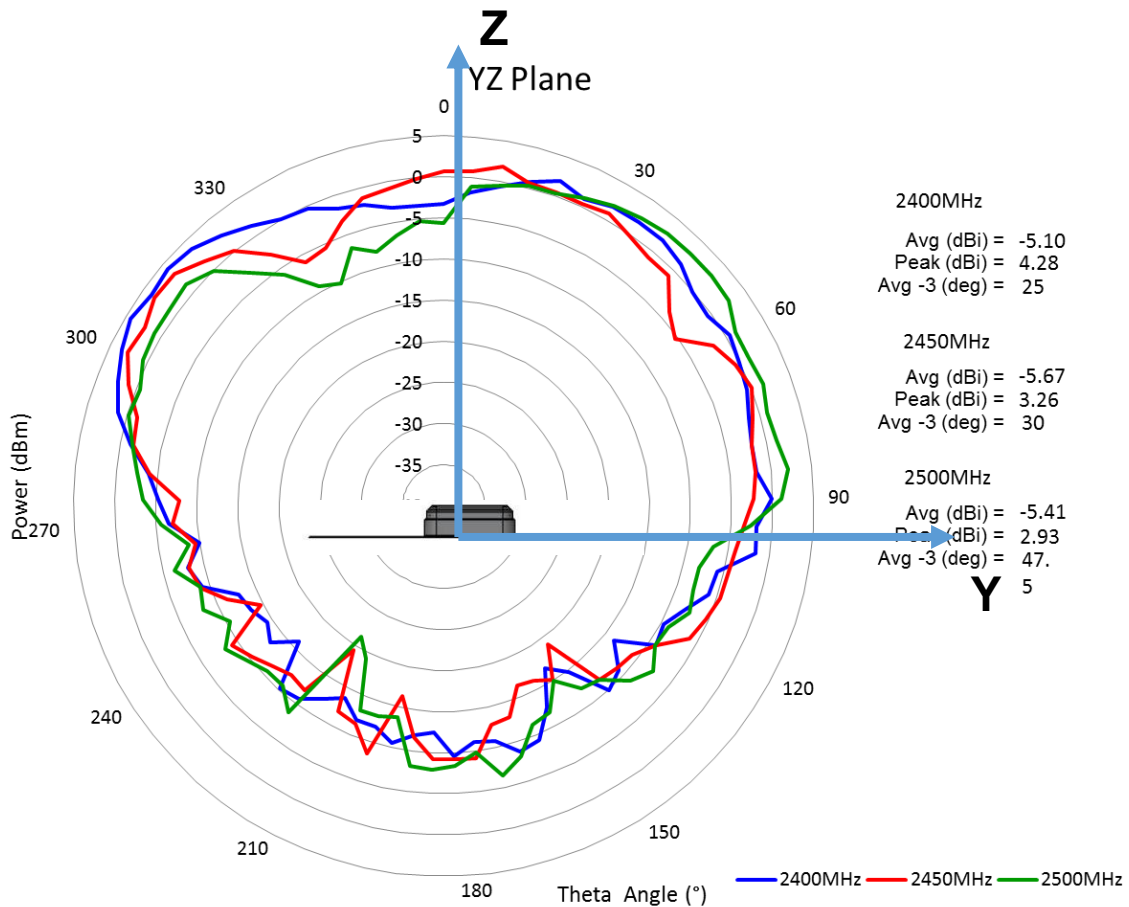

* Test on bracket and diameter is 500mm ground plane

CHARTS

Gain Plots WIFI*

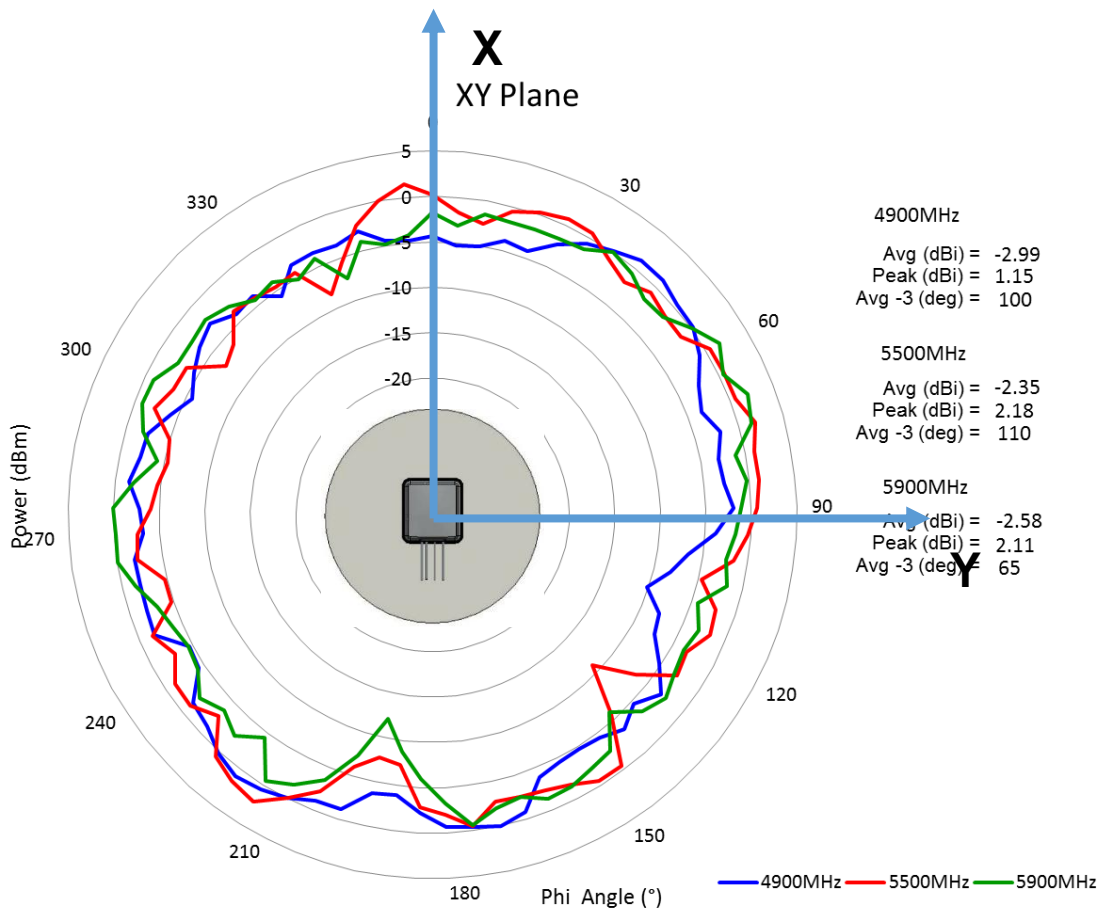

* Test on bracket and diameter is 500mm ground plane

Issue: 1720

In the effort to improve our products, we reserve the right to make changes judged to be necessary.
CONFIDENTIAL AND PROPRIETARY INFORMATION

This document contains confidential and proprietary information of Pulse Electronics, Inc. (Pulse) and is protected by copyright, trade secret and other state and federal laws. Its receipt or possession does not convey any rights to reproduce, disclose its contents, or to manufacture, use or sell anything it may describe. Reproduction, disclosure or use without specific written authorization of Pulse is strictly forbidden.

CHARTS

Gain Plots WIFI*

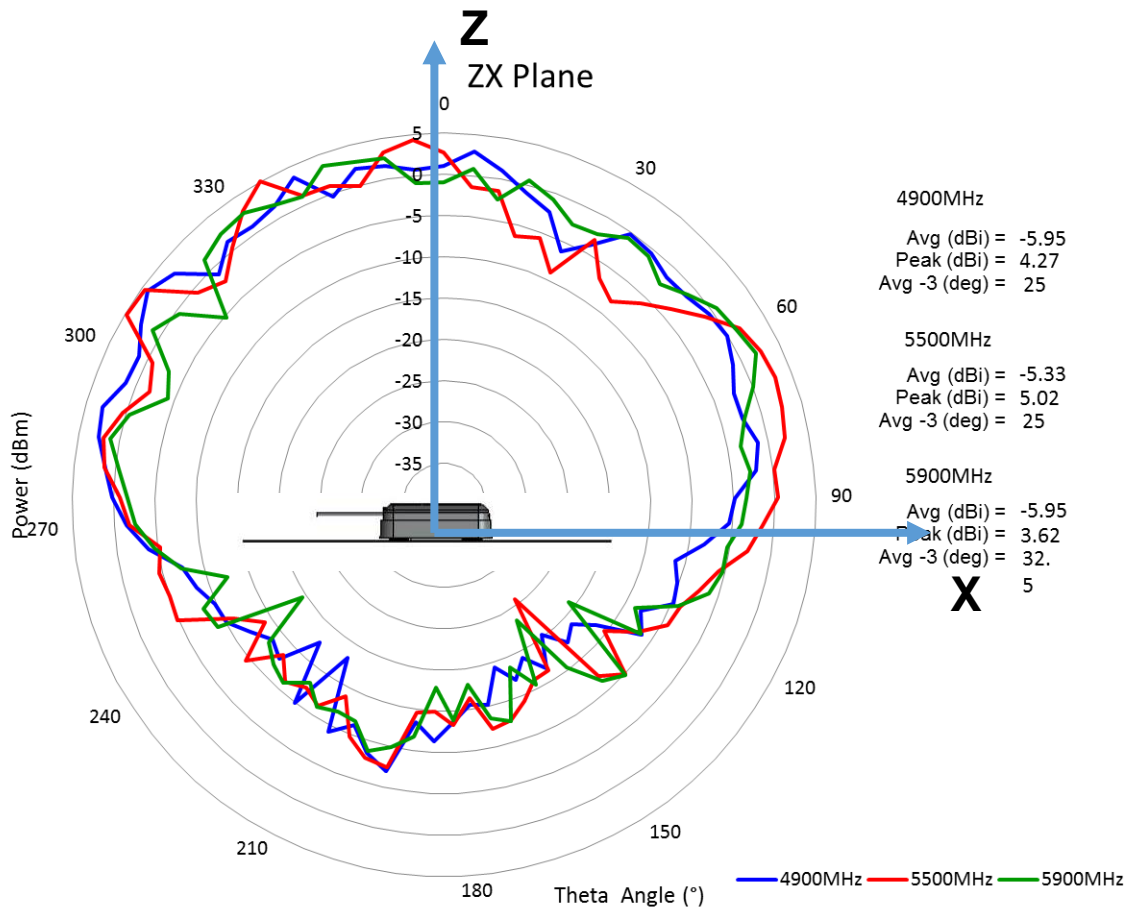

* Test on bracket and diameter is 500mm ground plane

Issue: 1720

In the effort to improve our products, we reserve the right to make changes judged to be necessary.
CONFIDENTIAL AND PROPRIETARY INFORMATION

This document contains confidential and proprietary information of Pulse Electronics, Inc. (Pulse) and is protected by copyright, trade secret and other state and federal laws. Its receipt or possession does not convey any rights to reproduce, disclose its contents, or to manufacture, use or sell anything it may describe. Reproduction, disclosure or use without specific written authorization of Pulse is strictly forbidden.

CHARTS

Gain Plots WIFI*

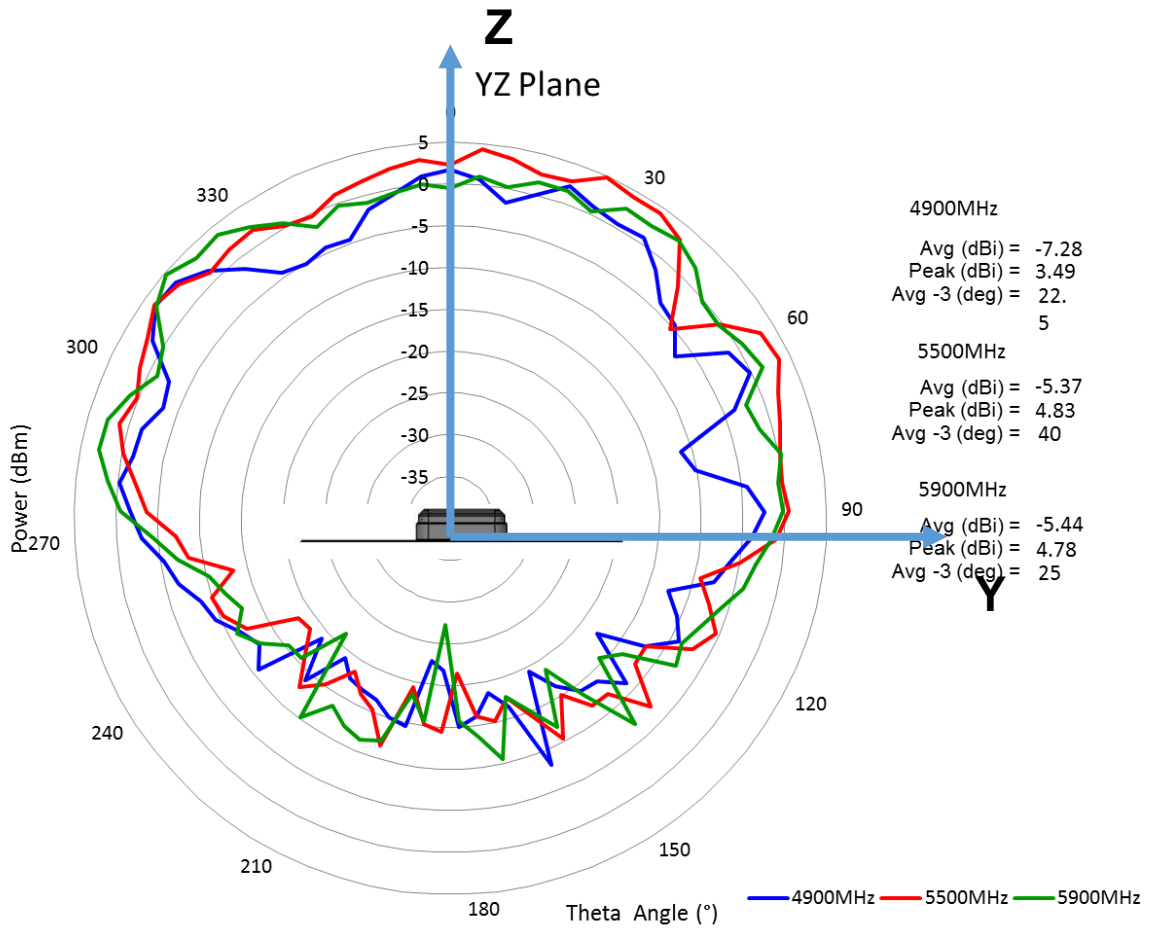

* Test on bracket and diameter is 500mm ground plane

Series: Jaguar

Description: 2xLTE, WiFi, GNSS Multiband
Vehicular Antenna

PART NUMBER: GPSPMB401

CHARTS

Radiation Pattern (70mm x 70mm ground plane) GPS & Galileo

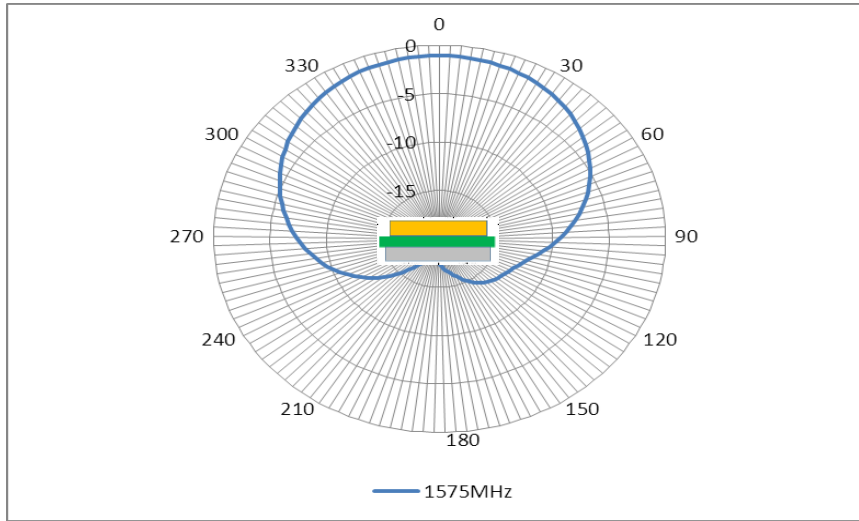

25 X 25 X 4mm Ceramic Antenna

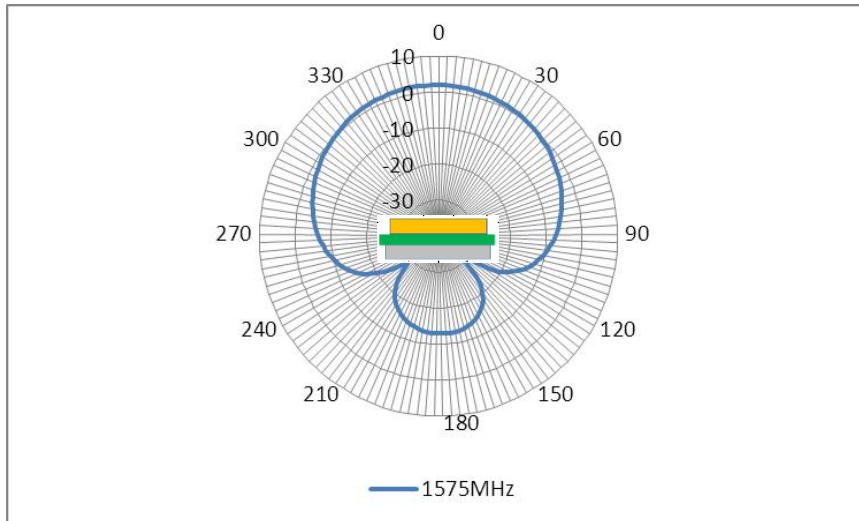

25 X 25 X 4mm Ceramic Antenna

Issue: 1720

In the effort to improve our products, we reserve the right to make changes judged to be necessary.

CONFIDENTIAL AND PROPRIETARY INFORMATION

This document contains confidential and proprietary information of Pulse Electronics, Inc. (Pulse) and is protected by copyright, trade secret and other state and federal laws. Its receipt or possession does not convey any rights to reproduce, disclose its contents, or to manufacture, use or sell anything it may describe. Reproduction, disclosure or use without specific written authorization of Pulse is strictly forbidden.

Description: 2xLTE, WiFi, GNSS Multiband
Vehicular Antenna

Series: Jaguar

PART NUMBER: GPSPMB401

CHARTS

Radiation Pattern (70mm x 70mm ground plane) GLONASS

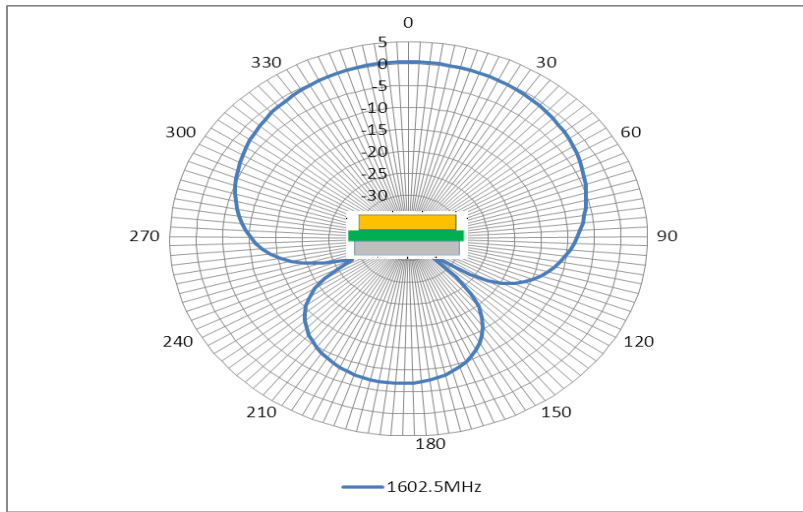

25 X 25 X 4mm Ceramic Antenna

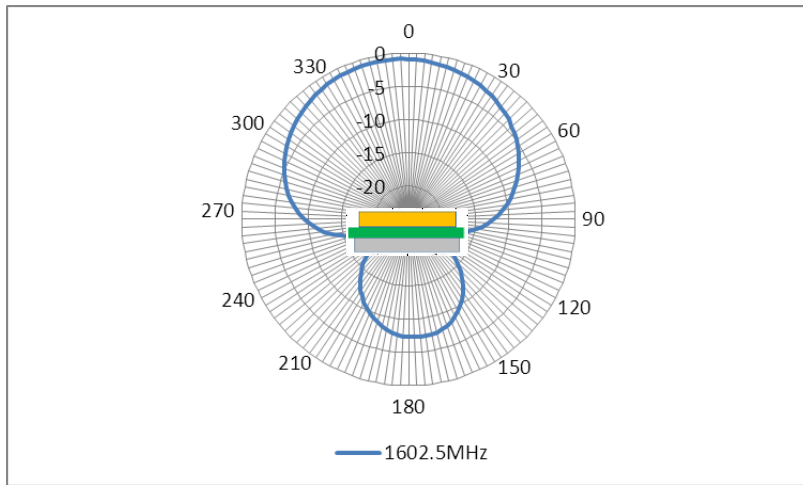

25 X 25 X 4mm Ceramic Antenna

Issue: 1720

In the effort to improve our products, we reserve the right to make changes judged to be necessary.

CONFIDENTIAL AND PROPRIETARY INFORMATION

This document contains confidential and proprietary information of Pulse Electronics, Inc. (Pulse) and is protected by copyright, trade secret and other state and federal laws. Its receipt or possession does not convey any rights to reproduce, disclose its contents, or to manufacture, use or sell anything it may describe. Reproduction, disclosure or use without specific written authorization of Pulse is strictly forbidden.

Description: 2xLTE, WiFi, GNSS Multiband Vehicular Antenna

Series: Jaguar

PART NUMBER: GPSPMB401

CHARTS

Radiation Pattern (70mm x 70mm ground plane) BD2

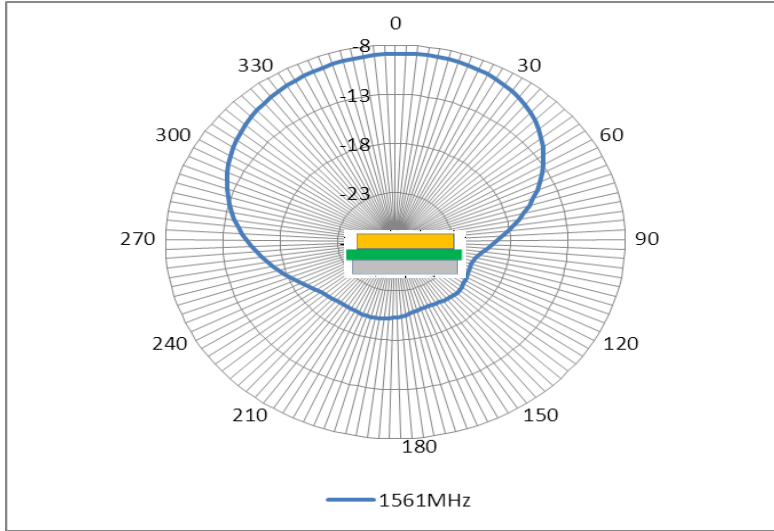

25 X 25 X 4mm Ceramic Antenna

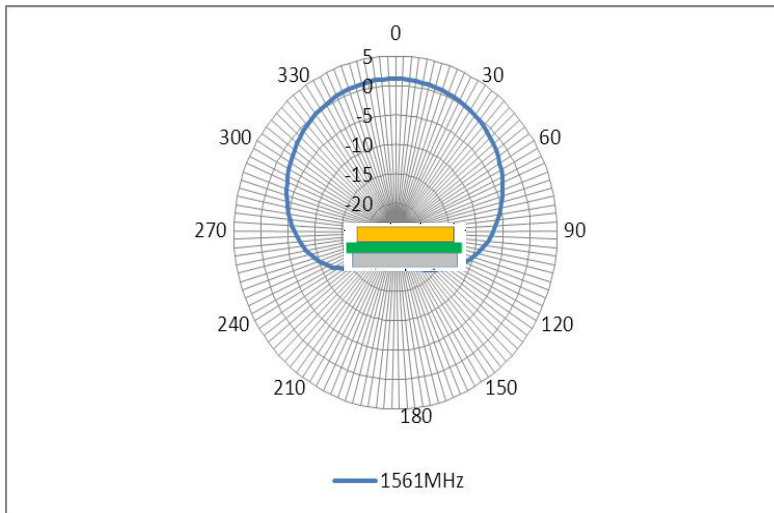

25 X 25 X 4mm Ceramic Antenna

Issue: 1720

In the effort to improve our products, we reserve the right to make changes judged to be necessary.

CONFIDENTIAL AND PROPRIETARY INFORMATION

This document contains confidential and proprietary information of Pulse Electronics, Inc. (Pulse) and is protected by copyright, trade secret and other state and federal laws. Its receipt or possession does not convey any rights to reproduce, disclose its contents, or to manufacture, use or sell anything it may describe. Reproduction, disclosure or use without specific written authorization of Pulse is strictly forbidden.

Series: Jaguar

Description: 2xLTE, WiFi, GNSS Multiband
Vehicular Antenna

PART NUMBER: GPSPMB401

PACKAGING

- Each antenna packed in a plastic bag
- 12 bags of antennas packed in a cardboard box.
- 1 label on each box with qty, part number, date code.

ASSEMBLY

When this antenna is applied to a non-metallic surface, like glass fiber or plastic material, it could be adhered on the surface directly.

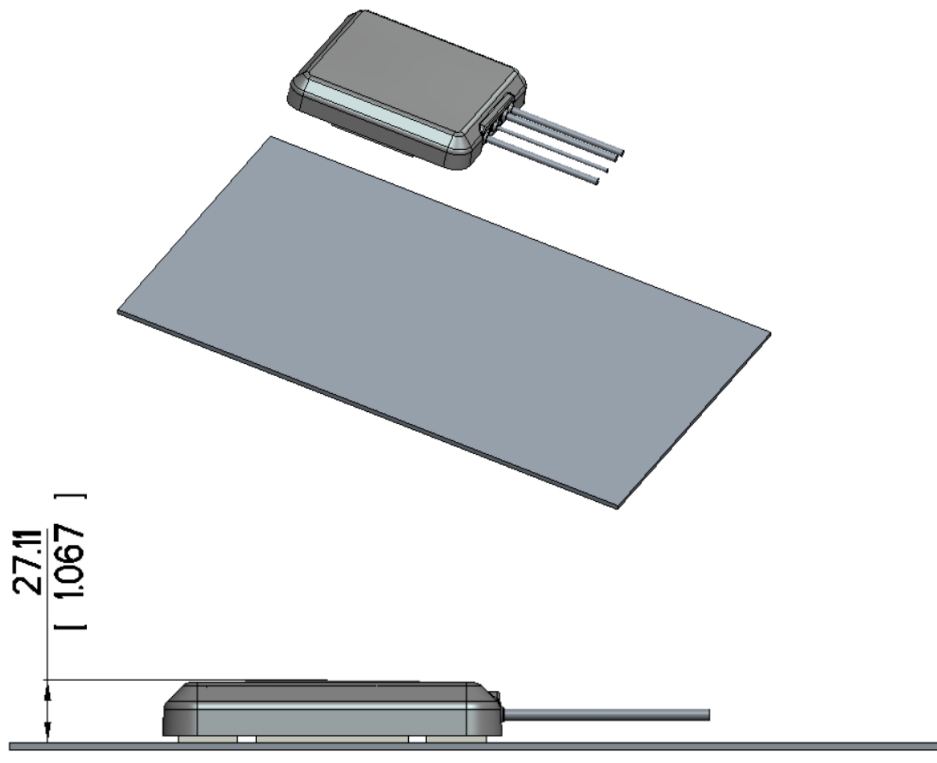

Issue: 1720

In the effort to improve our products, we reserve the right to make changes judged to be necessary.

CONFIDENTIAL AND PROPRIETARY INFORMATION

This document contains confidential and proprietary information of Pulse Electronics, Inc. (Pulse) and is protected by copyright, trade secret and other state and federal laws. Its receipt or possession does not convey any rights to reproduce, disclose its contents, or to manufacture, use or sell anything it may describe. Reproduction, disclosure or use without specific written authorization of Pulse is strictly forbidden.

Series: Jaguar

Description: 2xLTE, WiFi, GNSS Multiband
Vehicular Antenna

PART NUMBER: GPSPMB401

ASSEMBLY

Mounting with a plastic bracket: When this antenna applied to the metal surface, a plastic bracket is needed to elevate the antenna 1" for the optimum RF performance.

Option 1, LPMB4BRACKETMM Magnetic Mount

----Removable Mounting (No Surface damage)

The mounting surface is made of steel or iron.

Firstly, The antenna adhered on the plastic bracket with magnets by the adhesive tape. Then the whole assemble could be attached on the iron metals by magnets, and also could be removed from the metal surface easily without surface damage.

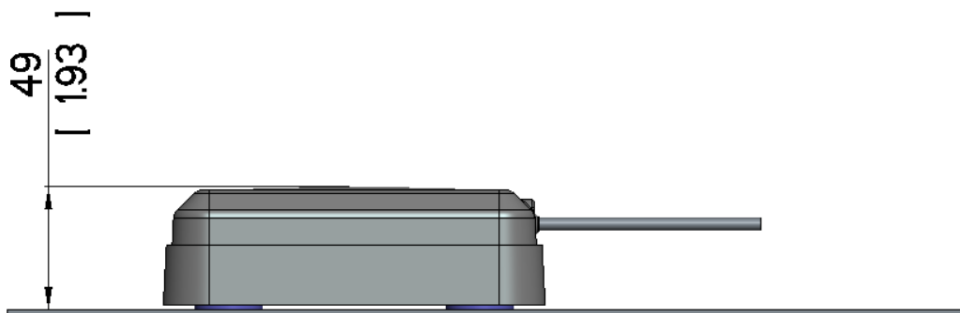
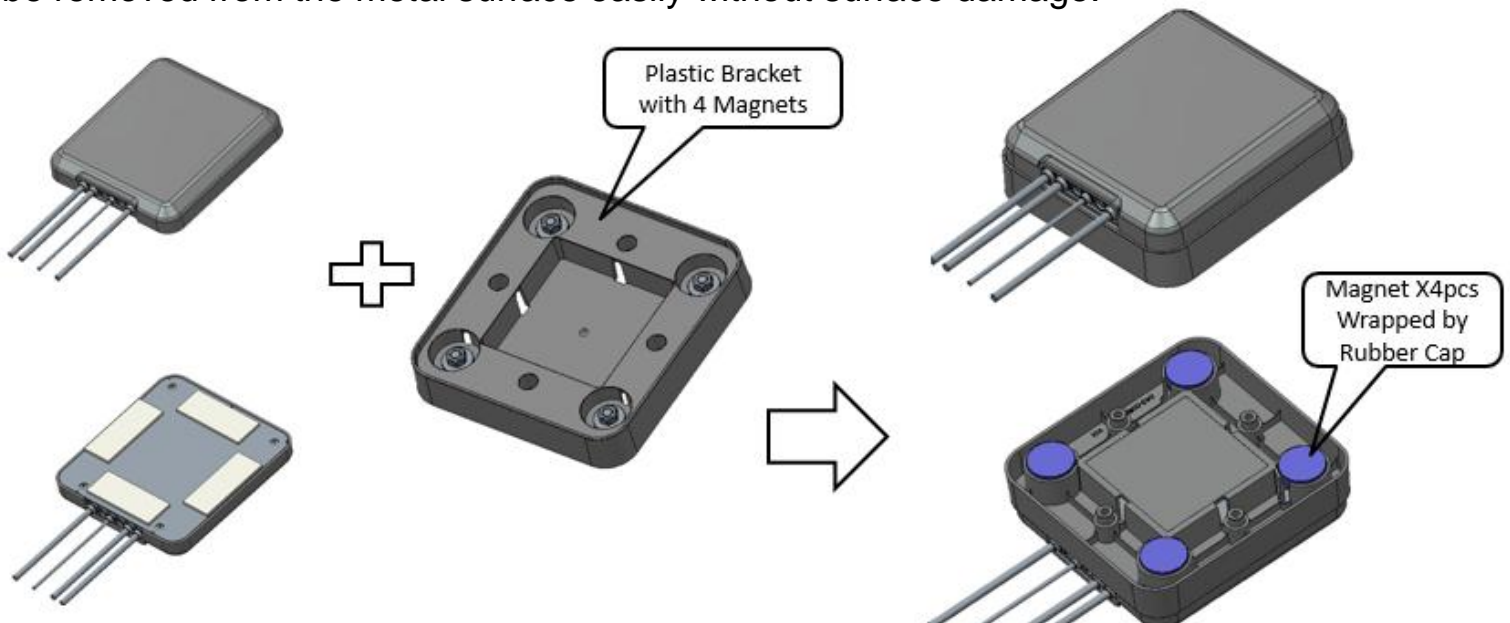

Issue: 1720

In the effort to improve our products, we reserve the right to make changes judged to be necessary.

CONFIDENTIAL AND PROPRIETARY INFORMATION

This document contains confidential and proprietary information of Pulse Electronics, Inc. (Pulse) and is protected by copyright, trade secret and other state and federal laws. Its receipt or possession does not convey any rights to reproduce, disclose its contents, or to manufacture, use or sell anything it may describe. Reproduction, disclosure or use without specific written authorization of Pulse is strictly forbidden.

ASSEMBLY

Option 2, LPMB4BRACKETAM Adhesive Mount -- Permanent Mount

Especially when the mounting surface is made of non-ferrum metals, like aluminum, Firstly, the antenna adhered on the plastic bracket by the adhesive tape,

Then the whole assemble could adhere on the mounting surface by the 3MVHB adhesive tape (3M VHB4959 70mmX70mm).

