

2M-Series

MINIATURE TOGGLES

The 2M family of miniature toggle switches is composed of three switch series; the **2M1-Series** miniature toggle switch, the **2MS-Series** sealed miniature toggle switch, and the **2M1H-Series** premium sealed miniature toggle switch. These series all feature PC mounting and offer a variety of ratings, circuits, contact materials, terminal platings, toggle styles and lengths, and optional color caps.

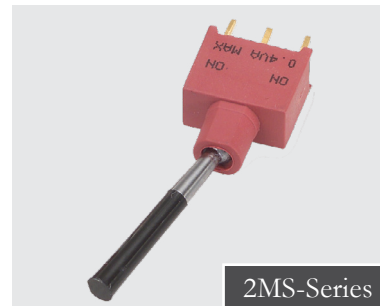

Product Highlights:

- IP67 Sealing
- 8 Single and Double Pole Circuits
- Long, Short and Flatted Bushing Options
- Large Variety of Termination Options
- Available Gold, Silver and Tin Platings
- UL Approved
- Sleek Black Finish

Typical Applications:

- Telecommunications
- Instrumentation
- Networking
- Medical Equipment
- Military Communications

Resources:

[Configure a Complete Part](#)

[Download CAD & Sales Drawing >](#)



Carling Technologies®

Innovative Designs. Powerful Solutions.

Carling Technologies, Inc.
60 Johnson Avenue, Plainville, CT 06062
Email: sales@carlingtech.com
Application Support: team2@carlingtech.com
Phone: 860.793.9281 Fax: 860.793.9231

www.carlingtech.com



2M1H-Series
Premium Sealed
Miniature
Toggle Switch



2MS-Series
Sealed
Miniature
Toggle Switch

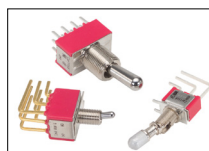

2M1-Series
Miniature
Toggle Switch

Electrical

Contact Rating	refer to ordering scheme
Electrical Life	50,000 make & break cycles @ full load
Contact Resistance	10 mΩ max. initial @ 2-4 VDC 100mA for both silver & gold plated contacts
Insulation Resistance	1000 MΩ min.
Dielectric Strength	1500 Volts RMS @ sea level

Physical

Operating Temperature	-30°C to +85°C
Index of Protection	<i>2M1H-Series:</i> IP67 <i>2MS-Series:</i> IP67
Solder Heat Resistance	MIL-STD-202, Method 210
Actuator Travel	25°

Material

Case	<i>2M1H-Series & 2M1-Series:</i> Diallyl phthalate (DAP) (UL 94V-0) <i>2MS-Series:</i> Glass filled nylon 6/6, flame retardant, heat stabilized (UL 94V-0)
Toggle	<i>2M1H-Series:</i> Brass, black finish with o-ring seal <i>2MS-Series:</i> Brass, chrome plated, internal o-ring sealed <i>2M1-Series:</i> Brass, chrome plated
Bushing	<i>2M1H-Series:</i> Brass, black finish with o-ring seal <i>2MS-Series:</i> Glass filled nylon 6/6, flame retardant, heat stabilized (UL 94V-0) <i>2M1-Series:</i> Brass, nickel plated
Housing	Stainless Steel
Bracket	<i>2MS-Series:</i> Nylon (UL 94V-0) <i>2M1-Series:</i> Stainless Steel
Actuator Pivot Retainer	<i>2MS-Series:</i> Stainless Steel
Switch Support	Brass, tin plated
Terminal Seal	Epoxy



1 SERIES
2M1H Premium Sealed Miniature Toggle Switch

2 POLE / CIRCUIT
() - momentary
Position: **1** **2** **3**

SP1	ON	Connected Terminals	2-3, 5-6	ON	2-1, 5-4
SP2	ON	NONE		(ON)	
SP3	ON	OFF		ON	
SP4	(ON)	OFF		(ON)	
SP5	ON	OFF		(ON)	
DP1	ON	NONE		ON	
DP2	ON	NONE		(ON)	
DP3	ON	OFF		ON	
DP4	(ON)	OFF		(ON)	
DP5	ON	OFF		(ON)	
DP6 *	ON	ON		ON	
DP7 *	(ON)	ON		(ON)	
DP8 *	ON	ON		(ON)	

*Center position connects 2-3, 5-4

3 ACTUATOR STYLE
TJ .709" [18 mm] length **TK** .512" [13.00 mm] length

4 BUSHING
BK .386" [9.80 mm] threaded, flat

5 TERMINATION ⁷

M1	Solder Lug	M51	Wire Wrap, .750" [19.05mm] length
M2	PCB	M52	Wire Wrap, .964" [24.48mm] length
M3	Quick Connect	M53	Wire Wrap, .425" [10.80mm] length
		M54	Wire Wrap, 1.062" [25.97mm] length

6 CONTACTS / TERMINALS

	Contact Material	Terminal Plating	Rating	Approvals
G	silver ¹	gold over silver	5A 125VAC or 28VDC, 2A 250VAC	IP67
K	gold ^{2,5}	tin ^{4,7}	0.4VA max 20V max (AC/DC)	IP67
P	silver ^{1,6}	tin ^{4,7}	5A 125VAC or 28VDC, 2A 250VAC	IP67
Q	silver ¹	silver ¹	5A 125VAC or 28VDC, 2A 250VAC	IP67
R	gold ²	gold ³	0.4VA max 20V max (AC/DC)	IP67

7 EPOXY SEAL
E Epoxy Seal

- Notes:
Switches supplied with (1) 2M1-HDW4 hex nut and (1) 3MNH-WCP-0872 O-Ring
- 1 Movable contact and terminal platings: silver over copper alloy
 - 2 Movable contact and terminal platings: gold over nickel over copper alloy
 - 3 Terminal platings: gold over nickel over copper alloy
 - 4 Terminal platings: tin over copper alloy
 - 5 Terminal contact platings: gold over nickel alloy
 - 6 Terminal contact platings: silver over nickel alloy
 - 7 Tin option not available with M1 & M3 terminations.

*Manufacturer reserves the right to change product specification without prior notice.

2MS - WSP 1 - T1 - B4 - M1 G E

1 Series 2 Poles 3 Circuit 4 Actuator Style 5 Bushing 6 Termination 7 Contacts 8 Seal

1 SERIES

2MS Sealed Miniature Toggle Switch

2 POLES

WSP Single pole - uses terminals 1, 2 & 3
WDP Double pole - uses terminals 1, 2, 3, 4, 5 & 6
W3P Three pole - uses terminals 1, 2, 3, 4, 5, 6, 7, 8 & 9

3 CIRCUIT

() - momentary

Position:	1	2	3
	2-3, 5-6, 8-9	Connected Terminals	2-1, 5-4, 8-7
1	ON	NONE	ON
2	ON	NONE	(ON)
3	ON	OFF	ON
4	(ON)	OFF	(ON)
5	ON	OFF	(ON)

4 ACTUATOR STYLE

T1 Round Bat **T9** Long Black Plastic .492" length
T2 Round Short Bat **P1** Plastic Anti-Static .496" length
P2 Plastic Anti-Static .299" length



5 BUSHING

B1 Threaded, Keyway **B4** Unthreaded, Short, Keyway, Flat

6 TERMINATION

M1 ⁴ Solder Lug	VS21 Vertical, Snap-In, .460" [11.70mm]
M2 PCB	VS3 Vertical, .630" [16mm]
M3 Quick Connect	VS31 Vertical, Snap-In, .630" [16mm]
M51 Wire Wrap, .750" [19.05mm]	U2 Vertical, .551" [14mm] - only 3PDT
M52 Wire Wrap, .964" [24.48mm]	VS4 Vertical, .461" [11.70mm]
M53 Wire Wrap, .425" [10.80mm]	VS41 Vertical, Snap-In, .461" [11.70mm]
M54 Wire Wrap, 1.062" [25.97mm]	U4 Vertical, .551" [14mm] - only 3PDT
M6 Right Angle, PC Thru-Hole	VS5 Vertical, .630" [16mm]
M61 Right Angle, Snap-In	VS51 Vertical, Snap-In, .630" [16mm]
M7 Vertical, Right Angle, PC Thru-Hole	
M71 Vertical, Right Angle, Snap-In	
VS2 Vertical, .461" [11.70mm]	

7 CONTACTS / TERMINALS

Contact Material	Terminal Plating	Rating	Approvals
G silver ¹	gold over silver	5A 125VAC or 28VDC, 2A 250VAC	e ¹  us, IP67
K gold ²	tin ^{3,4}	0.4VA max 20V max (AC/DC)	IP67
P silver ¹	tin ^{3,4}	5A 125VAC or 28VDC, 2A 250VAC	e ¹  us, IP67
R gold ²	gold ²	0.4VA max 20V max (AC/DC)	IP67

8 EPOXY SEAL

E Epoxy Seal **0** without Epoxy Seal

Notes:

- B1 Bushing switches supplied with (2) 2M1-HDW2 nuts, (1) 2M1-HDW11 washer and (1) 2M1-HDW15 locking ring. See page 76-77.
 1 Movable contact & terminal platings: silver over copper alloy
 2 Movable contact & terminal platings: gold over nickel over copper alloy
 3 Terminal platings: tin over nickel over copper alloy
 4 Tin option not available with M1 terminal

2M1 - SP 1 - T1 - B1 - M1 Q E

1 Series 2 Poles 3 Circuit 4 Actuator Style 5 Bushing 6 Termination 7 Contacts 8 Seal

1 SERIES

2M1 Miniature Toggle Switch

2 POLES

SP Single pole - uses terminals 1, 2 & 3
DP Double pole - uses terminals 1, 2, 3, 4, 5 & 6
3P Three pole - uses terminals 1, 2, 3, 4, 5, 6, 7, 8 & 9
4P Four pole - uses terminals 1, 2, 3, 4, 5, 6, 7, 8, 9, 10, 11 & 12

3 CIRCUIT

() - momentary

Position:	1	2	3
	2-3, 5-6, 8-9, 11-12	Connected Terminals	2-1, 5-4, 8-7, 11-10
1	ON	NONE	ON
2	ON	NONE	(ON)
3	ON	OFF	ON
4	(ON)	OFF	(ON)
5	ON	OFF	(ON)
6*	ON	ON	ON
7*	(ON)	ON	(ON)
8*	ON	ON	(ON)

*Available with DP and 4P switches only. Center position connects 2-3, 5-4, 8-9, 11-10

4 ACTUATOR STYLE

T1 Round Bat **T7** Large Bat (B0 bushing)
T2 Round Short Bat **T8** X-Large Bat (B0 bushing)
T3 Paddle **T9** Black Plastic
T4 Medium Paddle **T0** Rectangular
T5 Long Paddle **TA** Locking Lever
T6 Flat (B1,B2,B5,BA,BB,BE) **TI** Locking Lever
TL Locking Lever







5 BUSHING

B1 Threaded Standard, keyway **B8** Metric
B2 Non-Threaded Standard, keyway **B9** Splashproof
B3 Threaded Short, keyway **B0** 15/32" Threaded (Standard for T7 & T8 actuator styles)
B4 Non-Threaded Short, keyway **BA** Threaded for T6
B5 High Torque, 7.5mm, flat **BB** Non-Threaded for T6
B6 High Torque, 8.0mm, keyway **BE** Threaded Hi Torque for T6
B7 Long threaded **BL** Threaded, Locking

6 TERMINATION

M1 ⁴ Solder Lug	M71 Vertical, Right Angle, Snap-In
M2 PCB	VS2 Vertical, .461" [11.70mm]
M3 Quick Connect	VS21 Vertical, Snap-In, .461" [11.70mm]
M51 Wire Wrap, .750" [19.05mm]	VS3 Vertical, .630" [16mm]
M52 Wire Wrap, .964" [24.48mm]	VS31 Vertical, Snap-In, .630" [16mm]
M53 Wire Wrap, .425" [10.80mm]	VS4 Vertical, .461" [11.70mm]
M54 Wire Wrap, 1.062" [25.97mm]	VS41 Vertical, Snap-In, .461" [11.70mm]
M6 Right Angle, PC Thru-Hole	VS5 Vertical, .630" [16mm]
M61 Right Angle, Snap-In	VS51 Vertical, Snap-In, .630" [16mm]
M7 Vertical, Right Angle, PC Thru-Hole	

7 CONTACTS / TERMINALS

Contact Material	Terminal Plating	Rating	Approvals
G silver ¹	gold over silver	5A 125VAC or 28VDC, 2A 250VAC	  IP67
K gold ²	tin ^{3,4}	0.4VA max 20V max (AC/DC)	N/A
P silver ¹	tin ^{3,4}	5A 125VAC or 28VDC, 2A 250VAC	  IP67
Q silver ¹	silver ¹	5A 125VAC or 28VDC, 2A 250VAC	  IP67
R gold ²	gold ²	0.4VA max 20V max (AC/DC)	N/A

8 EPOXY SEAL

E Epoxy Seal **0** without Epoxy Seal

Notes:

- B1 Bushing switches supplied with (2) 2M1-HDW2 nuts, (1) 2M1-HDW11 washer and (1) 2M1-HDW15 locking ring.
 1 Movable contact & terminal platings: silver over copper alloy
 2 Movable contact & terminal platings: gold over nickel over copper alloy
 3 Terminal platings: tin over nickel over copper alloy
 4 Tin option not available with M1 terminal

2M-Series Accessories

To order accessories assembled on a switch, specify the switch number followed by the accessory part number and the word "assembled". Ex: 2M1-SP1-T1-B1-M1QE-T12 ASSEMBLED. To order accessories in bulk, specify the Series, followed by the accessory. Ex: 2M1-T12. See page 76 for dimensional specifications.

Optional Toggle Cap

2M1 - **T1** **2**

¹
Series

²
Toggle Cap Size

³
Color

1 SERIES

2M1 Fits 2M1H, 2MS or 2M1

3 CAP COLOR

1	White	5	Yellow
2	Black	6	Green
3	Red	7	Blue

2 TOGGLE CAP SIZE

T1 10.6 mm **T2** 7.6 mm

Optional Dress and Knurled Nuts

2M1 - **HDW3**

¹
Series

²
Nut

1 SERIES

2M1 Fits 2M1H, 2MS or 2M1

2 NUT

HDW3 Dress nut for 1/4" bushing
HDW5 Knurled nut for 15/32" bushing (2M1-Series only)

Optional Rubber Seals

2M1 - **E1A**

¹
Series

²
Rubber Boot Seal

1 SERIES

2M1 Fits 2M1H, 2MS or 2M1

2 RUBBER BOOT SEAL

E1A 1/4 - 40" UNS bushing (Not available for B0 bushing option)
K1 Metric M6 bushing (B8 bushing only)
YE1D 15/32 - 32" UNS bushing (TJ, TK and B0 bushings only)
YE1E 15/32 - 32" UNS bushing 1/2 boot (T7, T8, TJ, TK and B0 bushings only)

3MNH - **WCP-0872**

¹
Series

²
Rubber O-Ring

1 SERIES

3MNH Fits 3MNH or 2M1H

2 RUBBER O-RING

WCP-0872 For 15/32 bushing option

2M1H-Series Dimensional Specifications: in. [mm]

Single Pole

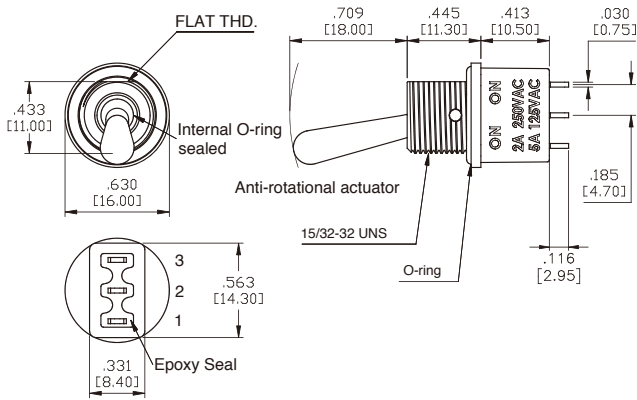

Double Pole

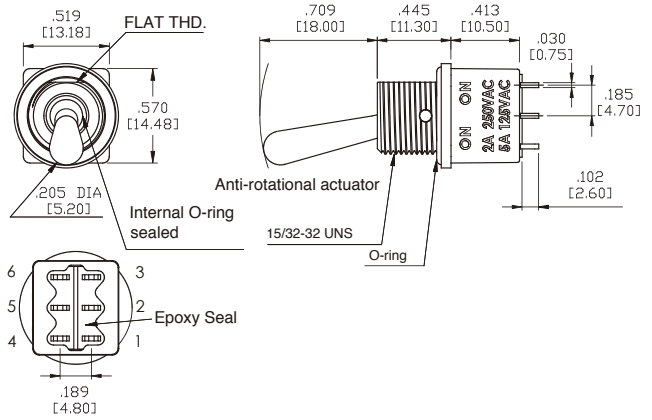

Actuator Options

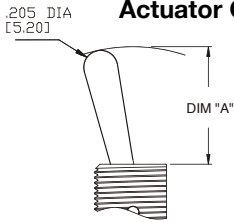

OPTION CODE	DIM. "A"
TJ	.709 [18.00]
TK	.512 [13.00]

Bushing Options & Mounting

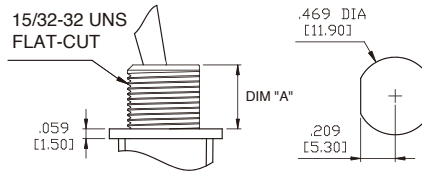

OPTION CODE	DIM. "A"
BK	.386 [9.80]

Termination Options

M1 Standard Solder Lug

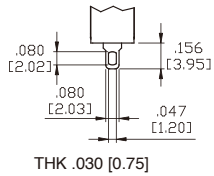

M2 PC Thru-Hole

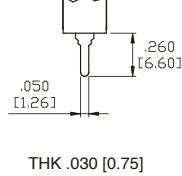

M3 Quick Connect

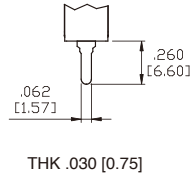

M5 Wire Wrap

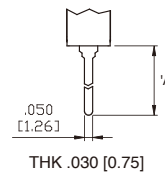

OPTION CODE	DIM. "A"
M5-1	.750 [19.05]
M5-2	.964 [24.48]
M5-3	.425 [10.80]
M5-4	1.062 [26.97]

2MS-Series Dimensional Specifications: in. [mm]

Single Pole

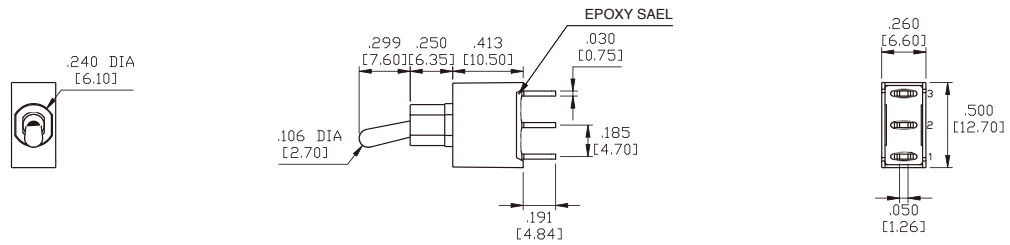

Double Pole

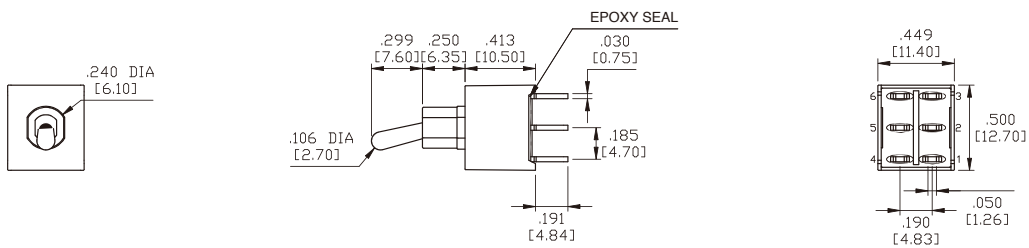

Three Pole

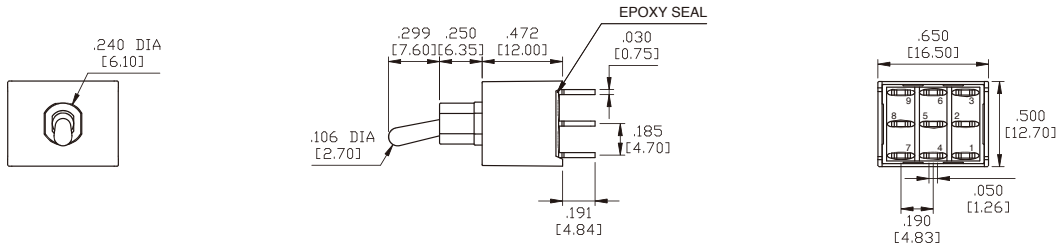

Actuator Options

T1

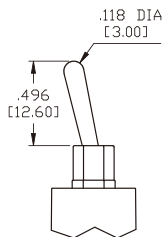

T2

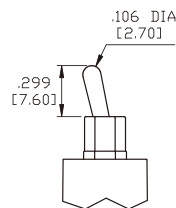

T9 with Plastic Cap

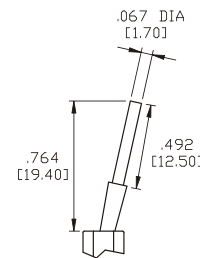

NO.	COLOR
1	White
2	Black(std.)
3	Red
4	Orange
5	Yellow
6	Green
7	Blue
8	Brown
9	Gray

P1 Plastic Toggle

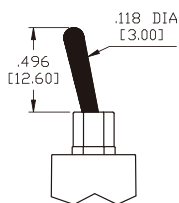

P2 Plastic Toggle

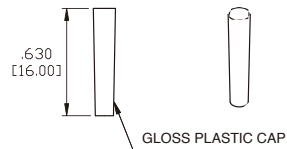
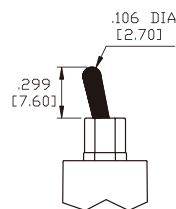

* Shown with B4 bushing. Subtract .075" (1.90 mm) from actuator height for B1 bushing.

2MS-Series Dimensional Specifications: in. [mm]

Bushing Options

B1

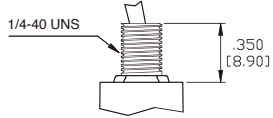

B4

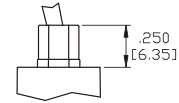

Termination Options

M1 Standard Solder Lug

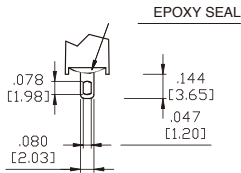

THK .030 [0.75]

M2 PC Thru-Hole

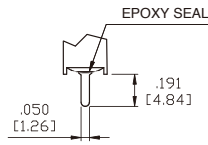

THK .030 [0.75]

M3 Quick Connect

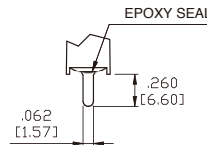

THK .030 [0.75]

M5 Wire Wrap

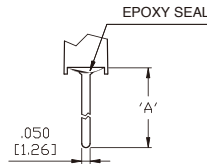

THK .030 [0.75]

OPTION CODE	DIM. 'A'
M5-1	.750 [19.05]
M5-2	.964 [24.48]
M5-3	.425 [10.80]
M5-4	1.062 [26.97]

M6 Single Pole

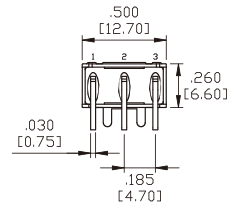
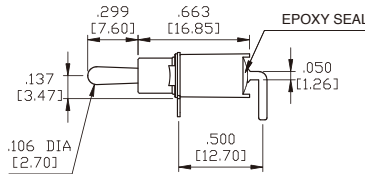
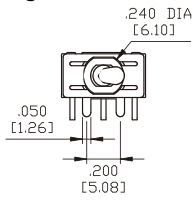

P.C.MOUNTING

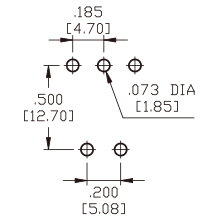

M6 Double Pole

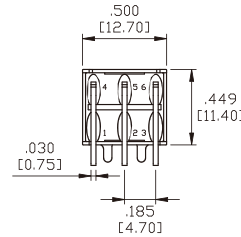
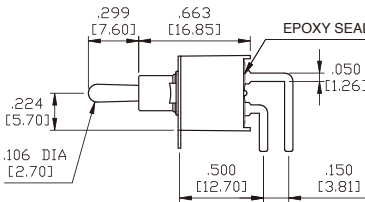
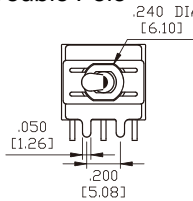

P.C.MOUNTING

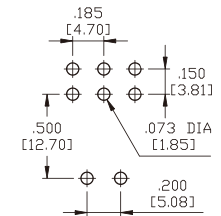

M6 Three Pole

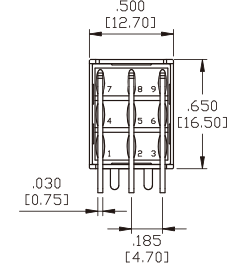
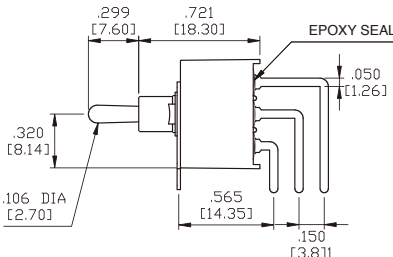
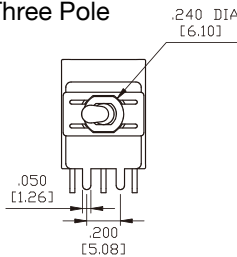

P.C.MOUNTING

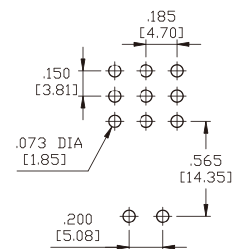

M7 Single Pole

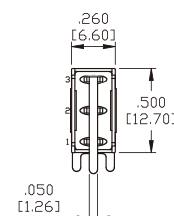
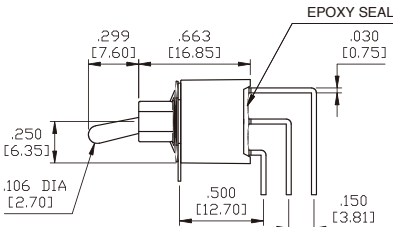
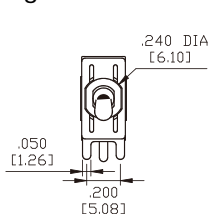

P.C.MOUNTING

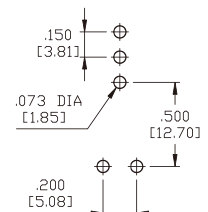

2MS-Series Dimensional Specifications: in. [mm]

Termination Options

M7 Double Pole

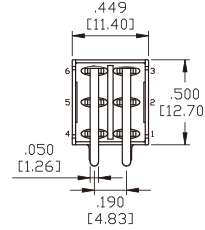
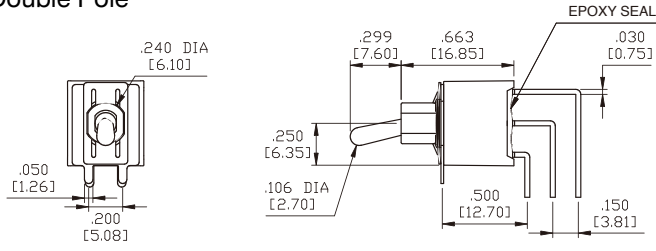

P.C.MOUNTING

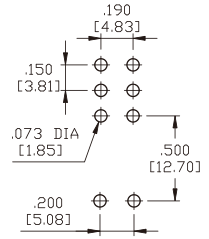

M7 Three Pole

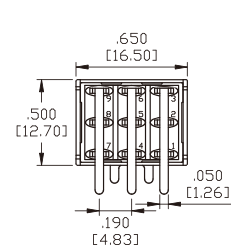
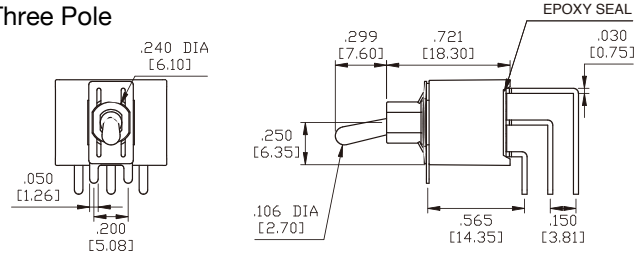

P.C.MOUNTING

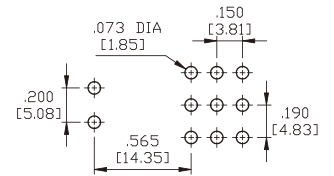

VS2-VS3 Single Pole

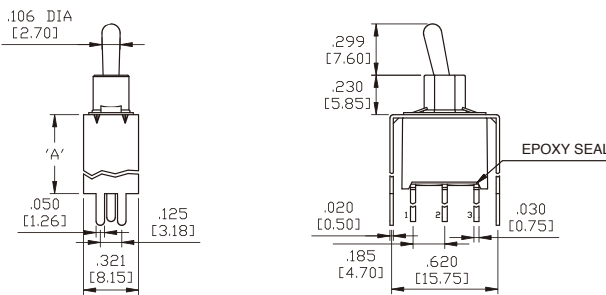

OPTION CODE	DIM.'A'
VS2	.461 [11.70]
VS3	.630 [16.00]

P.C.MOUNTING

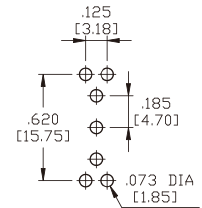

VS2-VS3 Double Pole

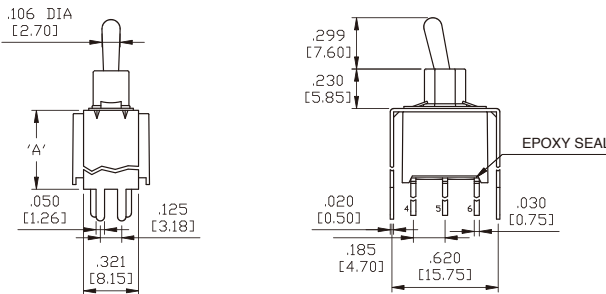

OPTION CODE	DIM.'A'
VS2	.461 [11.70]
VS3	.630 [16.00]

P.C.MOUNTING

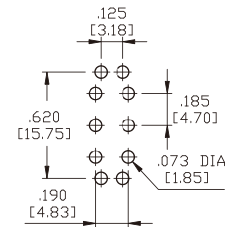

U2-VS3 Three Pole

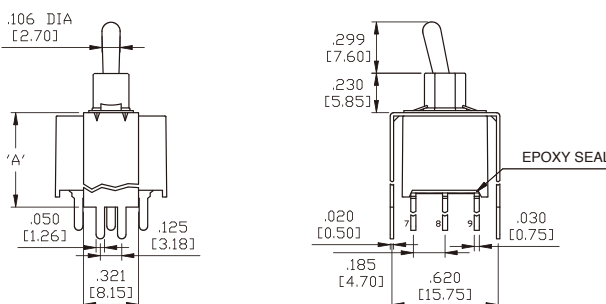

OPTION CODE	DIM.'A'
U2	.551 [14.00]
VS3	.630 [16.00]

P.C.MOUNTING

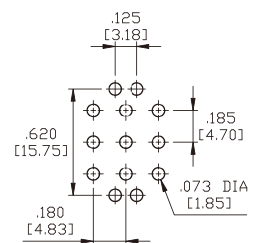

2MS-Series Dimensional Specifications: in. [mm]

Termination Options

VS4-VS5 Single Pole

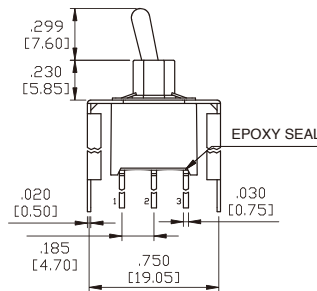
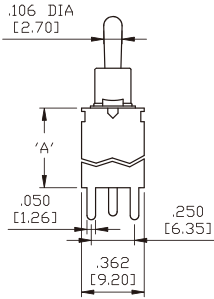

OPTION CODE	DIM.'A'
VS4	.461 [11.70]
VS5	.630 [16.00]

P.C.MOUNTING

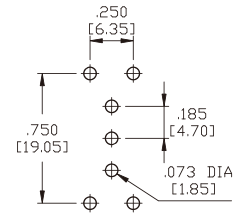

VS4-VS5 Double Pole

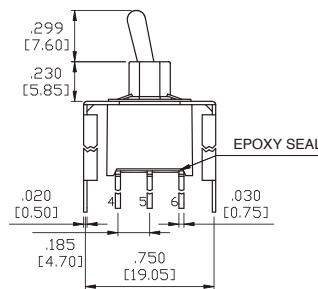
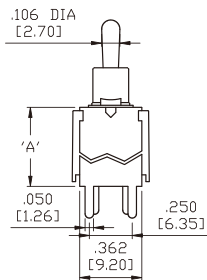

OPTION CODE	DIM.'A'
VS4	.461 [11.70]
VS5	.630 [16.00]

P.C.MOUNTING

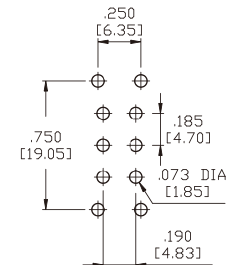

U4-VS5 Three Pole

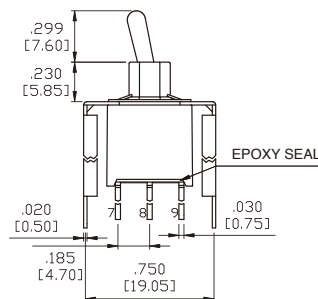
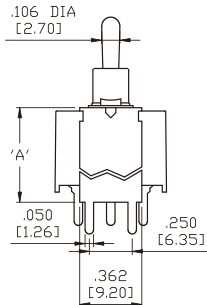

OPTION CODE	DIM.'A'
U4	.551 [14.00]
VS5	.630 [16.00]

P.C.MOUNTING

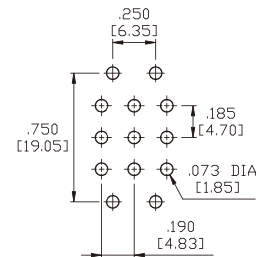

Snap-In Termination Options

M61

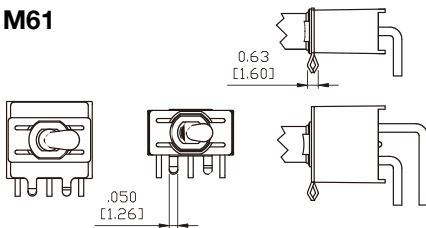

VS21, VS31

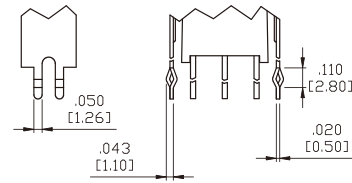

M71

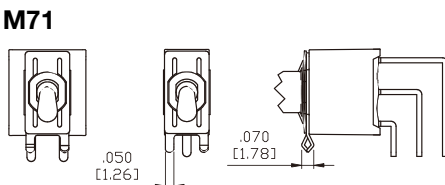

VS41, VS51

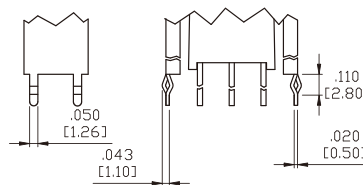

* PC Mounting for M61, M71, VS21, VS31, VS41, VS51 refer to M6, M7, VS2, VS3, VS4, VS5 respectively.

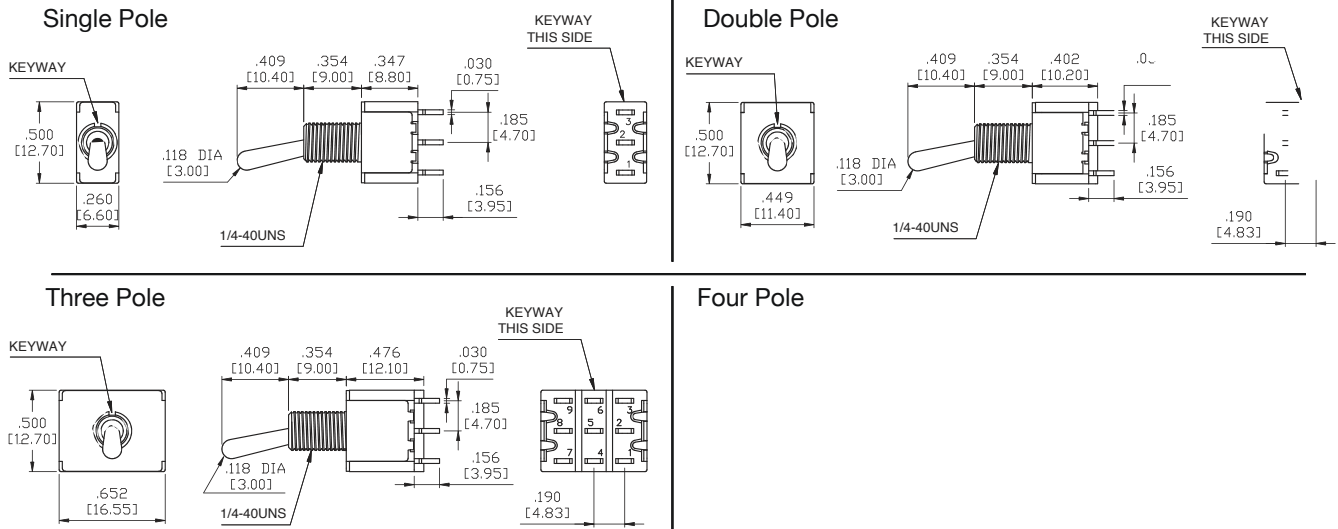

Actuator Options for Panel Rear Mount

T1	T2	T3	T4	T5
T6	T7 P7 Anti-Rotation	T8 P8 Anti-Rotation	T9 Plastic	T0

Bushing Options

2M1-Series Dimensional Specifications: in. [mm]

Bushing Options

B7 Long

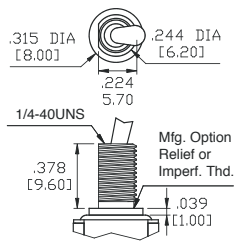

B8 Metric

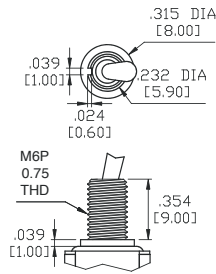

B9 Splash-Proof

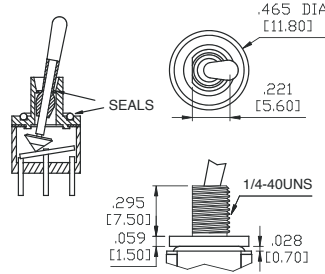

BL Locking Lever

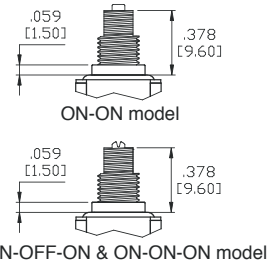

BA Threaded for T6

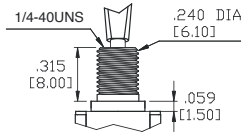

BB Non-Threaded for T6

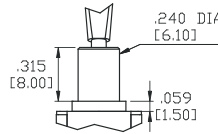

BB High Torque for T6

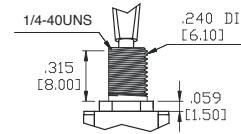

Panel Mounting

1/4 INCH BUSHING

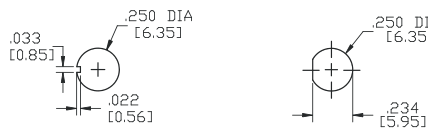

15/32 INCH BUSHING

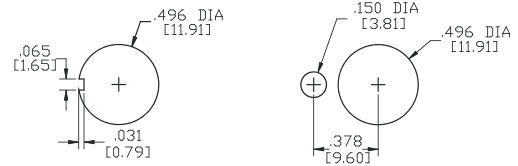

Termination Options

M1 Standard Solder Lug

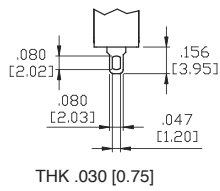

M2 PC Thru-Hole

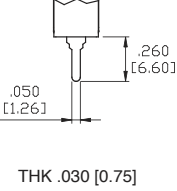

M3 Quick Connect

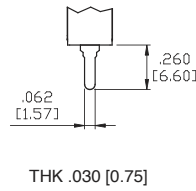

M5 Wire Wrap

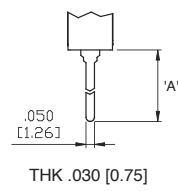

OPTION CODE	DIM.'A'
M5-1	.750 [19.05]
M5-2	.964 [24.48]
M5-3	.425 [10.80]
M5-4	1.062 [26.97]

M6 Single Pole

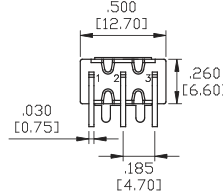
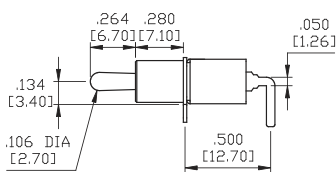
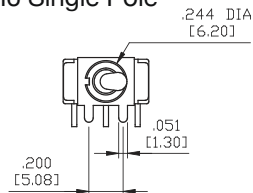

P.C. MOUNTING

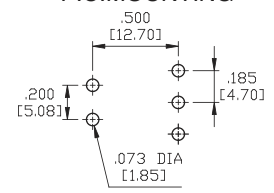

M6 Double Pole

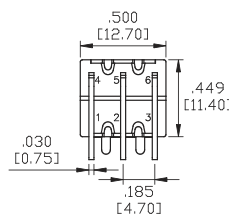
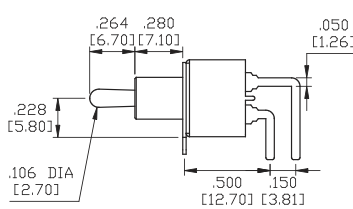
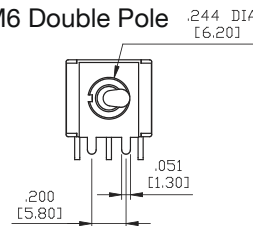

P.C. MOUNTING

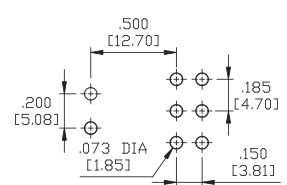

2M1-Series Dimensional Specifications: in. [mm]

Termination Options

M6 Three Pole .244 DIA [6.20]

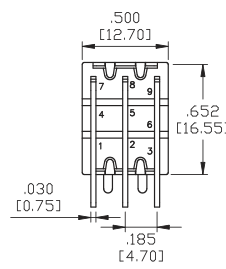
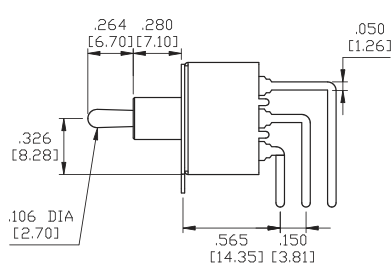
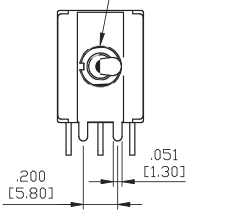

P.C.MOUNTING

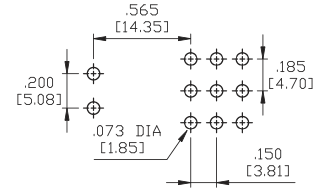

M7 Single Pole .244 DIA [6.20]

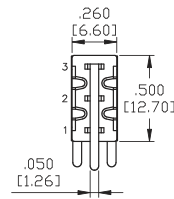
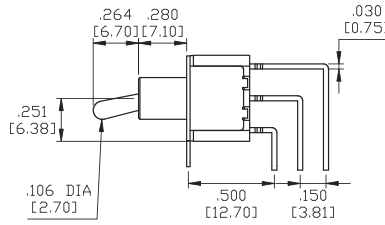
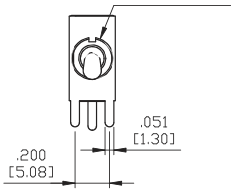

P.C.MOUNTING

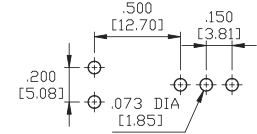

M7 Double Pole .244 DIA [6.20]

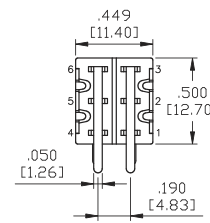
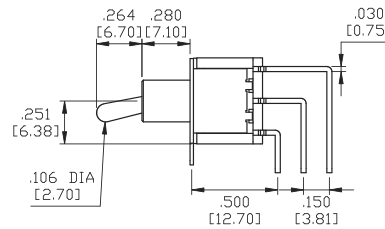
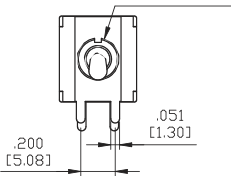

P.C.MOUNTING

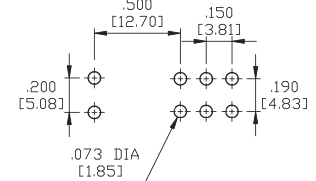

M7 Three Pole .244 DIA [6.20]

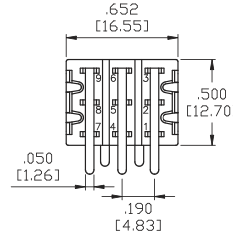
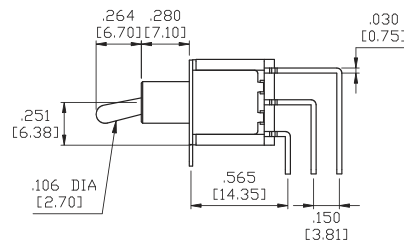
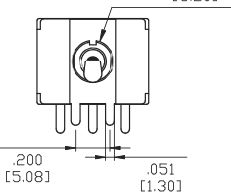

P.C.MOUNTING

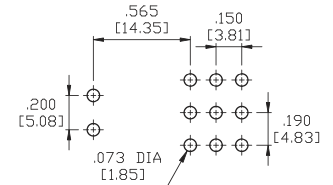

M7 Four Pole .244 DIA [6.20]

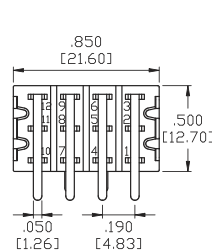
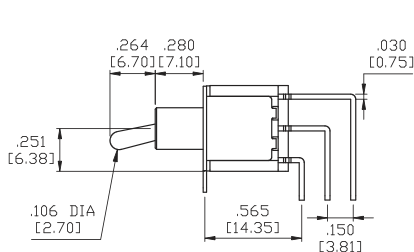
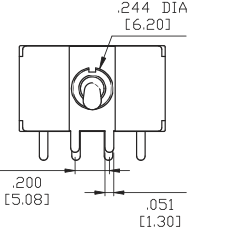

P.C.MOUNTING

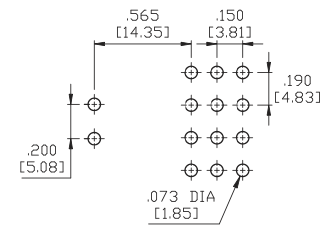

VS2-VS3 Single Pole

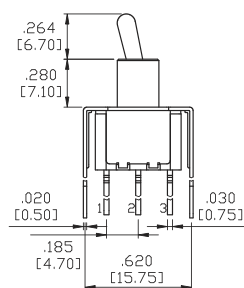
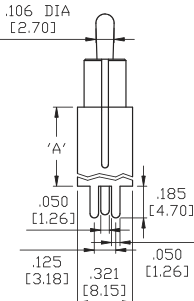

OPTION CODE	DIM. 'A'
VS2	.461 [11.70]
VS3	.630 [16.00]

P.C.MOUNTING

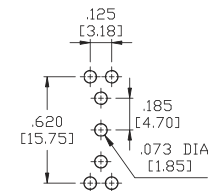

2M1-Series Dimensional Specifications: in. [mm]

Termination Options

VS2-VS3 Double Pole

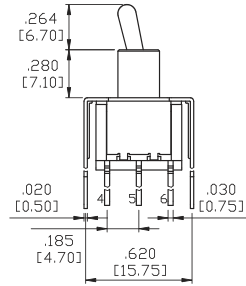
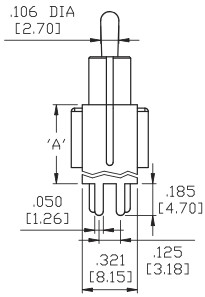

OPTION CODE	DIM. 'A'
VS2	.461 [11.70]
VS3	.630 [16.00]

P.C.MOUNTING

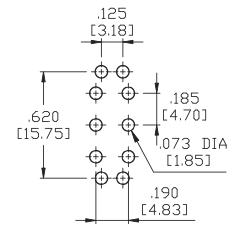

VS4-VS5 Single Pole

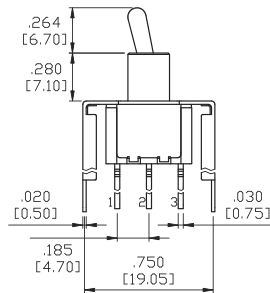
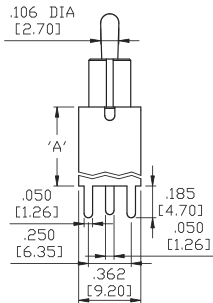

OPTION CODE	DIM. 'A'
VS4	.461 [11.70]
VS5	.630 [16.00]

P.C.MOUNTING

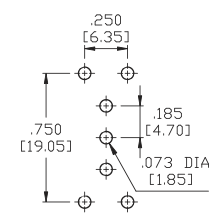

VS4-VS5 Double Pole

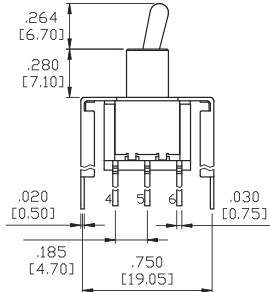
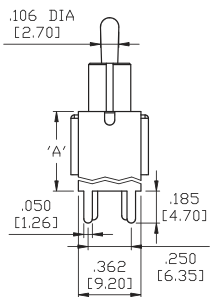

OPTION CODE	DIM. 'A'
VS4	.461 [11.70]
VS5	.630 [16.00]

P.C.MOUNTING

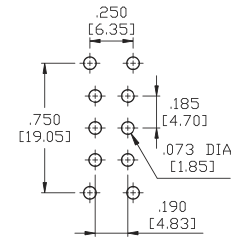

Snap-In Termination Options

M61 (available with SP & DP)

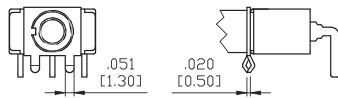

VS21, VS31

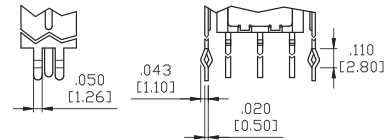

M71 (available with SP & DP)

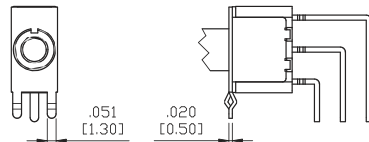

VS41, VS51

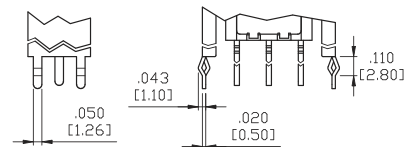

* PC Mounting for M61, M71, VS21, VS31, VS41, VS51 refer to M6, M7, VS2, VS3, VS4, VS5 respectively.

Authorized Sales Representatives and Distributors

Click on a region of the map below to find your local representatives and distributors or visit www.carlingtech.com/findarep.



About Carling

Founded in 1920, Carling Technologies is a leading manufacturer of electrical and electronic switches and assemblies, circuit breakers, electronic controls, power distribution units, and multiplexed power distribution systems. With four ISO registered manufacturing facilities and technical sales offices worldwide, Carling Technologies Sales, Service and Engineering teams do much more than manufacture electrical components, they engineer powerful solutions! To learn more about Carling please visit www.carlingtech.com/company-profile.

To view all of Carling's environmental, quality, health & safety certifications please visit www.carlingtech.com/environmental-certifications

Worldwide Headquarters

Carling Technologies, Inc.
60 Johnson Avenue, Plainville, CT 06062
Phone: 860.793.9281 **Fax:** 860.793.9231
Email: sales@carlingtech.com

Northern Region Sales Office: nrsm@carlingtech.com
Southeast Region Sales Office: sersm@carlingtech.com
Midwest Region Sales Office: mrrsm@carlingtech.com
West Region Sales Office: wrsm@carlingtech.com
Latin America Sales Office: larsm@carlingtech.com

Asia-Pacific Headquarters

Carling Technologies, Asia-Pacific Ltd.,
Suite 1607, 16/F Tower 2, The Gateway,
Harbour City, 25 Canton Road,
Tsimshatsui, Kowloon, Hong Kong
Phone: Int + 852-2737-2277 **Fax:** Int + 852-2736-9332
Email: sales@carlingtech.com.hk

Shenzhen, China: shenzhen@carlingtech.com
Shanghai, China: shanghai@carlingtech.com
Pune, India: india@carlingtech.com
Kaohsiung, Taiwan: taiwan@carlingtech.com
Yokohama, Japan: japan@carlingtech.com

Europe | Middle East | Africa Headquarters

Carling Technologies LTD
4 Airport Business Park, Exeter Airport,
Clyst Honiton, Exeter, Devon, EX5 2UL, UK
Phone: Int + 44 1392.364422 **Fax:** Int + 44 1392.364477
Email: ltd.sales@carlingtech.com

Germany: gmbh@carlingtech.com
France: sas@carlingtech.com



Carling Technologies®

Innovative Designs. Powerful Solutions.