

Relay Terminal

G70R-SOC08

CSM_G70R-SOC08_DS_E_2_1

Space-saving and Labor-saving 8-point Output Block

- Relay terminal is just 136 × 80 × 55 mm (W × H × D, when mounted upright).
- Independent contacts and short bar allow easy common connections.
- The common can now be connected with a short bar in the G70D-SOC08 and G70R-SOC08.
- No tools are required to remove Relays, so Relay replacement is easier than ever.
- The attached terminal cover prevents shocks.
- Equipped with operation indicators.
- Built-in diodes absorb coil surge.
- Mount either to DIN rail or via screws.

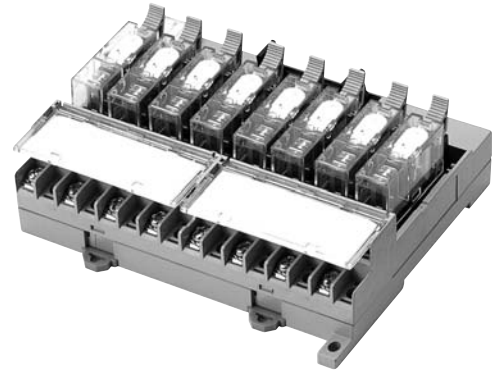

Ordering Information

Relay Terminal

Classification	Points	Internal I/O common	Rated voltage	Model
Relay outputs	8 points (SPST-NO × 8)	NPN (+common)	24 V DC	G70R-SOC08

Note: This is all non-standard model and require a special order. Contact your OMRON representative for details on availability.

Accessories (Order Separately)

Short Bar

Applicable Output Relay Terminals	Model
G70D-SOC08 G70R-SOC08	G6B-4-SB

Cables for I/O Relay Terminals XW2Z-R

- Cable with Loose Wire and Crimp Terminals: XW2Z-RY□C
- Cable with Loose Wires: XW2Z-RA□C
- Cable with connectors
 - Fujitsu connectors (1:1): XW2Z-R□C
 - (1:2): XW2Z-RI□C-□
 - (1:3): XW2Z-RO□C-□
 - (1:3): XW2Z-R□C-□-□
 - MIL connectors (1:1): XW2Z-RI□C
 - (1:1): XW2Z-RO□C
 - (1:2): XW2Z-RI□-□-D□
 - XW2Z-RM□-□-D□
 - XW2Z-RO□-□-D1

Check the internal circuit before use and confirm the pins to be used. Refer to the **XW2Z-R** Datasheet (Cat. No. G126) for details.

Replacement Relays

Applicable Output Relay Terminal	Rated voltage	Model
G70R-SOC08	24 V DC	G2R-1-S DC24 G2R-1-SN DC24

Accessories for DIN Track Mounting

Refer to your OMRON website for details on the PFP-□.

Specifications

Ratings

Relay Specifications (G2R Relay)

The following specifications apply to G2R Relays mounted in a G70R-SOC08 Relay Terminal and not the G2R Relay itself.

Coil Ratings (per G2R Relay)

Rated voltage	24 V DC
Rated current	25.8 mA
Coil resistance	1,100 Ω
Must-operate voltage	70% max. of rated voltage
Must release voltage	15% min. of rated voltage
Max. voltage	130% of rated voltage
Power consumption	Approx. 530 mW

- Note:**
1. The must-operate voltage is 75% or less of the rated voltage if the relay is mounted upside down.
 2. Rated current and coil resistance were measured at a coil temperature of 23° C with a tolerance of ±10%.
 3. Operating characteristics were measured at a coil temperature of 23° C.
 4. The maximum allowable voltage is the maximum value of the allowable voltage range for the relay coil operating power supply. There is no continuous allowance.
 5. The rated current includes the terminal's LED current.

Contact Ratings (per G2R Relay)

Load	Resistive load ($\cos\phi = 1$)	
Rated load	10 A at 250 V AC, 10 A at 30 V DC	
Rated carry current	10 A	
Max. switching voltage	380 V AC, 125 V DC	
Max. switching current	10 A	
Max. switching capacity (reference value)	2,500 VA, 300 W	
Min. permissible load (reference value) *	10 mA at 5 V DC	
Endurance	Electrical	100,000 operations min. (under and at the rated load at 1,800 operations/h)
	Mechanical	10,000,000 operations min. (at 18,000 operations/h)

* This value is for a switching frequency of 120 times per minute.

Characteristics

Model	G70R-SOC08	
Classification	Relay outputs	
Contact configuration	8 points (SPST-NO × 8)	
Contact structure	Single	
Contact resistance #1	30 mΩ max.	
Must-operate time #2	15 ms max.	
Release time #2	15 ms max.	
Max. switching frequency	Mechanical	18,000 operations/h
	Rated load	1,800 operations/h
Insulation resistance	100 MΩ min. (at 500 V DC)	
Dielectric strength	Between coil and contact	2,000 V AC for 1 min between coil and contact
	Between contacts of same polarity	750 V AC for 1 min
	Between contacts of different polarity	1,500 V AC for 1 min
Vibration resistance	Destruction	10 to 55 to 10 Hz, 0.5-mm amplitude (1.0-mm double)
	Malfunction	10 to 55 to 10 Hz, 0.5-mm amplitude (1.0-mm double)
Shock resistance	Destruction	300 m/s ²
	Malfunction	100 m/s ²
Noise immunity	Power input (normal mode)	600 V for 10 min with a pulse width of 100 ns to 1 μs
	Power input (common mode)	1.5 kV for 10 min with a pulse width of 100 ns to 1 μs
	Input cable (coiling)	1.5 kV for 10 min with a pulse width of 100 ns to 1 μs
	Unit body (coiling)	600 V for 10 min with a pulse width of 100 ns to 1 μs
Operating voltage range	24 V DC ^{+10%} / _{-15%}	
Current consumption #3	Approx. 185 mA at 24 V DC	
Cable length	Between block and controller	5 m max. (reference value for AWG24)
	Between block and external device	Determine appropriate length for the connected load.
LED indicator color	Orange	
Coil surge absorber	Diode	
Ambient operating temperature	-10 to 55°C	
Ambient storage temperature	35% to 85%	
Ambient operating humidity	-20 to 65°C	
Mounting strength	No damage when 49 N pull load was applied for 1 s in all directions (except for 9.8 N in direction of rail)	
Terminal strength	Tightening torque	9.8 N·m
	Pull strength	49 N for 1 min
Weight	Approx. 350 g	

Note: These values are initial values.

*1. Measurement: 1 A at 5 V DC

*2. Ambient temperature: 23°C

*3. The current consumption is the value when all points are ON and includes the G2R Relay coil current.

Engineering Data (Reference Value)

Endurance Curve

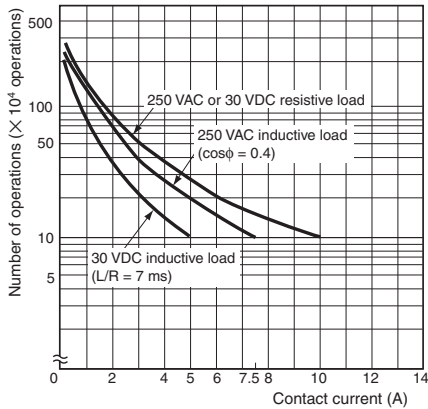

Maximum Switching Capacity

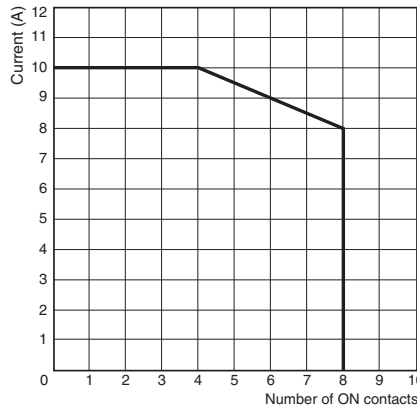

Note: The data shown in these graphs is based on actual values sampled from a production line; please use this data for reference only. As a general rule, allow for slight variations in the Relays because the Relays are mass produced.

- When using with a carry current of 10 A, no more than 4 contacts may be ON.
- The carry current is 8 A when all contacts are ON.

Internal Circuits

Arrangement of Connector Pins (TOP VIEW)

RY100...(1)	20	• •	19 (11)
RY101...(2)	18	• •	17 (12)
RY102...(3)	16	• •	15 (13)
RY103...(4)	14	• •	13 (14)
RY104...(5)	12	• •	11 (15)
RY105...(6)	10	• •	9 (16)
RY106...(7)	8	• •	7 (17)
RY107...(8)	6	• •	5 (18)
0V...(9)	4	• •	3 (19)...0V
24V...(10)	2	• •	1 (20)...24V

▲ mark

The number in parentheses is the marking tube number when an OMRON XW2Z-RY□C cable is used. Although the connector has 20 pins, pins (11) to (18) are not connected.

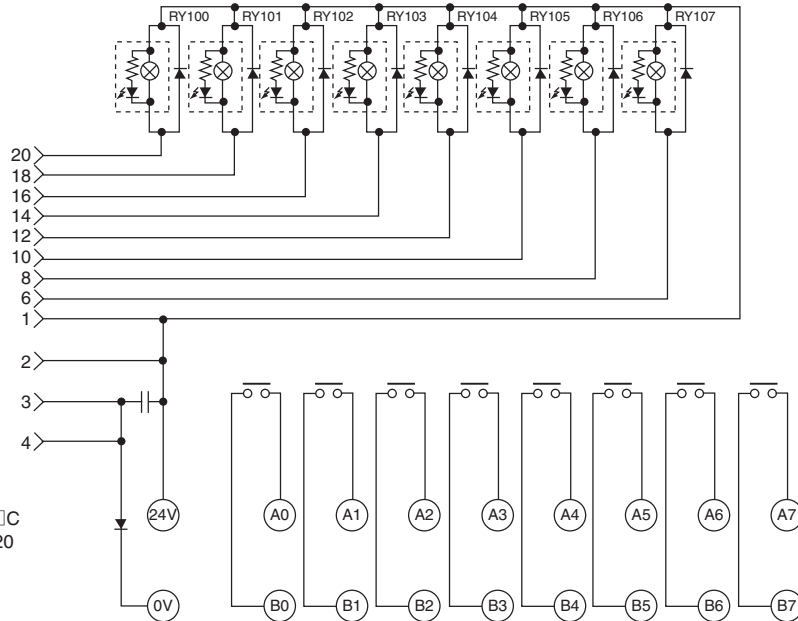

Note: Orders for G79 series connector cables will no longer be accepted after the end of March, 2017.

Dimensions

(Unit: mm)

Relay Terminal
G70R-SOC08

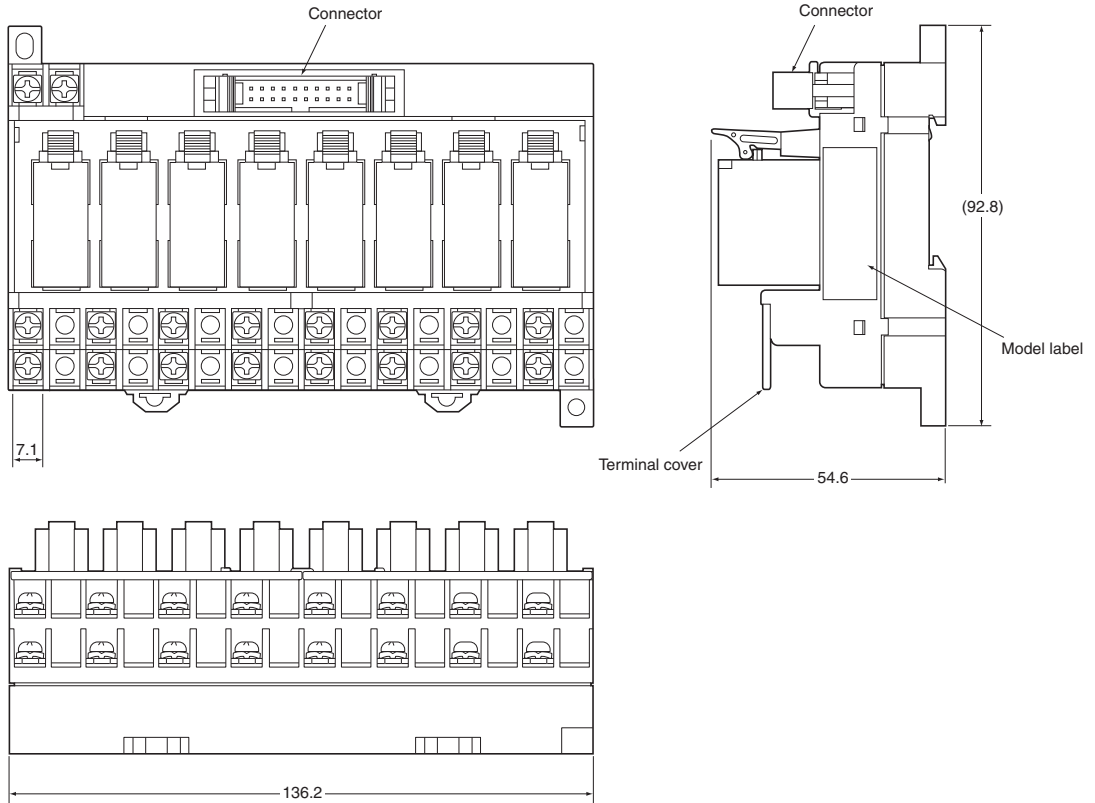

Accessories (Order Separately)

Short Bar
G6B-4-SB

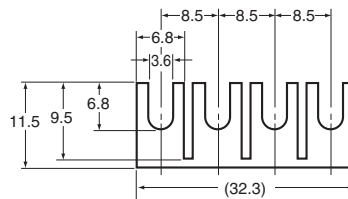

Terminal Arrangement/Terminal Connection Example

G70R-SOC08

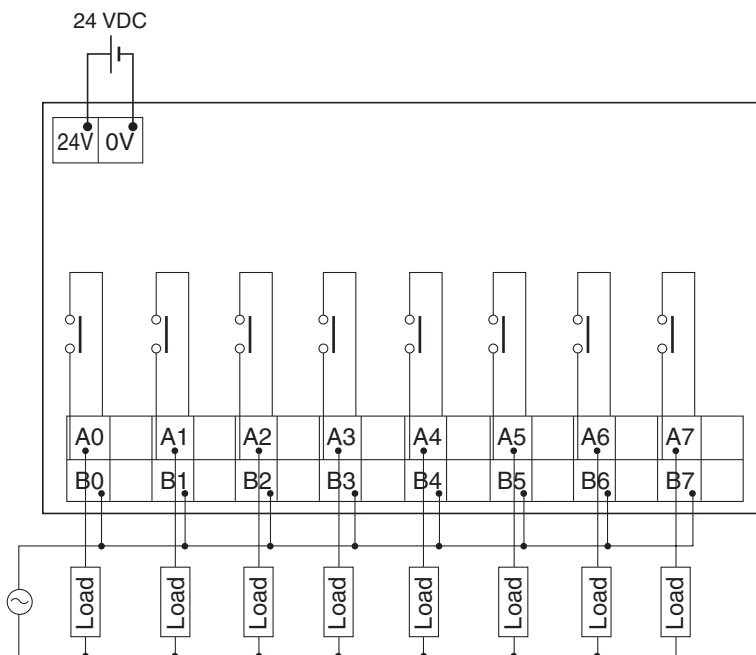

- Since the voltage to be applied is specified, supply the power that meets the voltage specification to the terminal (24V, 0V) when using the relay terminal. The terminal (A0 to 7, B0 to 7) are contact outputs. Therefore supply the power that meets the load. Short-circuit boards are also available.
- The power take-in terminal serve to supply the relay drive power and the controller output transistor power. Match the controller voltage with the relay terminal voltage. Use the power supply having least noise.

Safety Precautions

Be sure to read *the Safety Precautions for All I/O Relay Terminals* in the website at: <http://www.ia.omron.com/>.

Warning Indications

Precautions for Safe Use	Supplementary comments on what to do or avoid doing, to use the product safely.
Precautions for Correct Use	Supplementary comments on what to do or avoid doing, to prevent failure to operate, malfunction, or undesirable effects on product performance.

Precautions for Safe Use

- Do not submit the product to abnormal shock. Doing so might result in faulty operation.
- Use the Unit with the correct power supply voltage. An incorrect power supply may result in a problem.
- Double-check all the wiring before turning on the power supply. Incorrect wiring may result in burning.
- Do not bend the cables beyond their natural limit. Doing so may break the cables.
- Do not pull the cables by the power beyond 30 N. Doing so may break the cables.
- Be sure to turn off the power supply before wiring. Once the power is turned on, keep the cover closed and do not touch the terminal block, otherwise an electrical shock accident may occur.
- Ensure DIN rail attachment or screw attachment.
- Never use the product under any load that exceeds the rated contact values including the switching capacities, otherwise the product will not operate correctly and damage or burning may occur with the product itself.
- Take appropriate measures to ensure that the specified power with the rated voltage and frequency is supplied. Be particularly careful in places where the power supply is unstable. An incorrect power supply may result in malfunction.
- Do not attempt to disassemble, repair, or modify any Units. Any attempt to do so may result in malfunction, fire, or electric shock.
- Apply specified voltage correctly to the input terminal. Application of wrong voltage will spoil the specified performance of this product and may break or burn the product itself.

Precautions for Correct Use

- Do not install the Unit in any of the following locations: Installing the Unit in the following locations may result in malfunction, electric shock, or burning.
 - Locations subject to condensation as the result of severe changes in temperature.
 - Locations subject to corrosive or flammable gases.
 - Locations subject to exposure to water, oil, or chemicals.
 - Locations subject to direct sunlight.
 - Locations subject to dust (especially iron dust) or salts.
 - Locations subject to shock or vibration.
 - Locations subject to temperatures or humidities outside the range specified in the specifications.
- Take appropriate and sufficient countermeasures when installing systems in the following locations. Inappropriate and insufficient measures may result in malfunction.
 - Locations close to power supplies.
 - Locations subject to static electricity or other forms of noise.
 - Locations subject to strong electromagnetic fields.
- When mounting a Relay, press the upper part of the Relay straight down until the Relay is locked with the hooks while making sure that none of the Relay terminals are bent. Not doing so may cause the I/O Terminal to malfunction or radiate heat.
- Never use paint thinner or similar solvents, which can discolor or dissolve the surface of the Unit.
- Avoid connecting and disconnecting connectors while the power is ON. Otherwise, misoperation may occur.

Terms and Conditions Agreement

Read and understand this catalog.

Please read and understand this catalog before purchasing the products. Please consult your OMRON representative if you have any questions or comments.

Warranties.

(a) Exclusive Warranty. Omron's exclusive warranty is that the Products will be free from defects in materials and workmanship for a period of twelve months from the date of sale by Omron (or such other period expressed in writing by Omron). Omron disclaims all other warranties, express or implied.

(b) Limitations. OMRON MAKES NO WARRANTY OR REPRESENTATION, EXPRESS OR IMPLIED, ABOUT NON-INFRINGEMENT, MERCHANTABILITY OR FITNESS FOR A PARTICULAR PURPOSE OF THE PRODUCTS. BUYER ACKNOWLEDGES THAT IT ALONE HAS DETERMINED THAT THE PRODUCTS WILL SUITABLY MEET THE REQUIREMENTS OF THEIR INTENDED USE.

Omron further disclaims all warranties and responsibility of any type for claims or expenses based on infringement by the Products or otherwise of any intellectual property right. (c) Buyer Remedy. Omron's sole obligation hereunder shall be, at Omron's election, to (i) replace (in the form originally shipped with Buyer responsible for labor charges for removal or replacement thereof) the non-complying Product, (ii) repair the non-complying Product, or (iii) repay or credit Buyer an amount equal to the purchase price of the non-complying Product; provided that in no event shall Omron be responsible for warranty, repair, indemnity or any other claims or expenses regarding the Products unless Omron's analysis confirms that the Products were properly handled, stored, installed and maintained and not subject to contamination, abuse, misuse or inappropriate modification. Return of any Products by Buyer must be approved in writing by Omron before shipment. Omron Companies shall not be liable for the suitability or unsuitability or the results from the use of Products in combination with any electrical or electronic components, circuits, system assemblies or any other materials or substances or environments. Any advice, recommendations or information given orally or in writing, are not to be construed as an amendment or addition to the above warranty.

See <http://www.omron.com/global/> or contact your Omron representative for published information.

Limitation on Liability; Etc.

OMRON COMPANIES SHALL NOT BE LIABLE FOR SPECIAL, INDIRECT, INCIDENTAL, OR CONSEQUENTIAL DAMAGES, LOSS OF PROFITS OR PRODUCTION OR COMMERCIAL LOSS IN ANY WAY CONNECTED WITH THE PRODUCTS, WHETHER SUCH CLAIM IS BASED IN CONTRACT, WARRANTY, NEGLIGENCE OR STRICT LIABILITY.

Further, in no event shall liability of Omron Companies exceed the individual price of the Product on which liability is asserted.

Suitability of Use.

Omron Companies shall not be responsible for conformity with any standards, codes or regulations which apply to the combination of the Product in the Buyer's application or use of the Product. At Buyer's request, Omron will provide applicable third party certification documents identifying ratings and limitations of use which apply to the Product. This information by itself is not sufficient for a complete determination of the suitability of the Product in combination with the end product, machine, system, or other application or use. Buyer shall be solely responsible for determining appropriateness of the particular Product with respect to Buyer's application, product or system. Buyer shall take application responsibility in all cases.

NEVER USE THE PRODUCT FOR AN APPLICATION INVOLVING SERIOUS RISK TO LIFE OR PROPERTY OR IN LARGE QUANTITIES WITHOUT ENSURING THAT THE SYSTEM AS A WHOLE HAS BEEN DESIGNED TO ADDRESS THE RISKS, AND THAT THE OMRON PRODUCT(S) IS PROPERLY RATED AND INSTALLED FOR THE INTENDED USE WITHIN THE OVERALL EQUIPMENT OR SYSTEM.

Programmable Products.

Omron Companies shall not be responsible for the user's programming of a programmable Product, or any consequence thereof.

Performance Data.

Data presented in Omron Company websites, catalogs and other materials is provided as a guide for the user in determining suitability and does not constitute a warranty. It may represent the result of Omron's test conditions, and the user must correlate it to actual application requirements. Actual performance is subject to the Omron's Warranty and Limitations of Liability.

Change in Specifications.

Product specifications and accessories may be changed at any time based on improvements and other reasons. It is our practice to change part numbers when published ratings or features are changed, or when significant construction changes are made. However, some specifications of the Product may be changed without any notice. When in doubt, special part numbers may be assigned to fix or establish key specifications for your application. Please consult with your Omron's representative at any time to confirm actual specifications of purchased Product.

Errors and Omissions.

Information presented by Omron Companies has been checked and is believed to be accurate; however, no responsibility is assumed for clerical, typographical or proofreading errors or omissions.

2017.9

In the interest of product improvement, specifications are subject to change without notice.

OMRON Corporation
Industrial Automation Company

<http://www.ia.omron.com/>

(c)Copyright OMRON Corporation 2017 All Right Reserved.